



Macro Assembler and Utilities

**Macro Assembler, Linker/Locator,
Library Manager, and Object-HEX Converter
for 8051, Extended 8051, and 251 Microcontrollers**

User's Guide 02.2001

Information in this document is subject to change without notice and does not represent a commitment on the part of the manufacturer. The software described in this document is furnished under license agreement or nondisclosure agreement and may be used or copied only in accordance with the terms of the agreement. It is against the law to copy the software on any medium except as specifically allowed in the license or nondisclosure agreement. The purchaser may make one copy of the software for backup purposes. No part of this manual may be reproduced or transmitted in any form or by any means, electronic or mechanical, including photocopying, recording, or information storage and retrieval systems, for any purpose other than for the purchaser's personal use, without written permission.

Copyright © 1988-2001 Keil Elektronik GmbH., and Keil Software, Inc.
All rights reserved.

Keil C51™, Keil C251™, μ Vision2™, and μ Vision2 Debugger™ are trademarks of Keil Elektronik GmbH.

Microsoft® and Windows™ are trademarks or registered trademarks of Microsoft Corporation.

Intel®, MCS® 51, MCS® 251, ASM-51®, and PL/M-51® are registered trademarks of Intel Corporation.

Every effort was made to ensure accuracy in this manual and to give appropriate credit to persons, companies, and trademarks referenced herein.

Preface

This manual describes how to use the A51, AX51, and A251 macro assemblers and the related utilities to translate assembly source code into executable programs for the 8051 and variants like the Philips 80C51MX and Intel/Atmel WM 251 devices. This manual assumes you are familiar with the Windows operating system and know how to program microcontrollers.

“Chapter 1. Introduction,” provides an overview of the different assembler variants and describes the basics of assembly language programming.

“Chapter 2. Architecture,” contains an overview of the 8051, extended 8051, Philips 80C51MX, and Intel/Atmel WM 251 devices.

“Chapter 3. Writing Assembly Programs,” describes assembler statements and the rules for arithmetic and logical expressions.

“Chapter 4. Assembler Directives,” describes how to define segments and symbols and how to use all directives.

“Chapter 5. Assembler Macros,” describes the function of the standard macros and contains information for using standard macros.

“Chapter 6. Macro Processing Language,” defines and describes the use of the Intel Macro Processing Language.

“Chapter 7. Invocation and Controls,” describes how to invoke the assembler and how to control the assembler operation.

“Chapter 8. Error Messages,” contains a list of all assembler error messages and describes their causes and how to avoid them.

“Chapter 9. Linker/Locator,” includes reference section of all linker/locator directives, along with examples and detailed descriptions.

“Chapter 10. Library Manager,” shows you how to create and maintain a library.

“Chapter 11. Object-Hex Converter,” describes how to create Intel HEX files.

The Appendix contains program examples, lists the differences between assembler versions, and contains other items of interest.

Document Conventions

This document uses the following conventions:

| Examples | Description |
|-----------------------------|---|
| README.TXT | <p>Bold capital text is used for the names of executable programs, data files, source files, environment variables, and commands you enter at the Windows command prompt. This text usually represents commands that you must type in literally. For example:</p> <p style="text-align: center;">CLS DIR BL51.EXE</p> <p>Note that you are not required to enter these commands using all capital letters.</p> |
| Courier | <p>Text in this typeface is used to represent information that displays on screen or prints at the printer.</p> <p>This typeface is also used within the text when discussing or describing command line items.</p> |
| <i>Variables</i> | <p>Text in italics represents information that you must provide. For example, <i>projectfile</i> in a syntax string means that you must supply the actual project file name.</p> <p>Occasionally, italics are also used to emphasize words in the text.</p> |
| Elements that repeat... | <p>Ellipses (...) are used in examples to indicate an item that may be repeated.</p> |
| Omitted code . . . | <p>Vertical ellipses are used in source code examples to indicate that a fragment of the program is omitted. For example:</p> <pre>void main (void) { . . . while (1);</pre> |
| [Optional Items] | <p>Optional arguments in command-line and option fields are indicated by double brackets. For example:</p> <pre>C51 TEST.C PRINT [(filename)]</pre> |
| {opt1 opt2} | <p>Text contained within braces, separated by a vertical bar represents a group of items from which one must be chosen. The braces enclose all of the choices and the vertical bars separate the choices. One item in the list must be selected.</p> |
| Keys | <p>Text in this sans serif typeface represents actual keys on the keyboard. For example, "Press Enter to continue."</p> |

Contents

| | |
|--|-----------|
| Chapter 1. Introduction..... | 15 |
| How to Develop A Program | 16 |
| What is an Assembler?..... | 16 |
| Modular Programming | 17 |
| Modular Program Development Process | 19 |
| Segments, Modules, and Programs | 19 |
| Translate and Link Process | 20 |
| Filename Extensions | 22 |
| Program Template File | 23 |
| Chapter 2. Architecture Overview | 27 |
| Memory Classes and Memory Layout | 27 |
| Classic 8051 | 28 |
| Classic 8051 Memory Layout | 29 |
| Extended 8051 Variants | 30 |
| Extended 8051 Memory Layout..... | 31 |
| Philips 80C51MX | 32 |
| 80C51MX Memory Layout..... | 33 |
| Intel/Atmel WM 251 | 34 |
| 251 Memory Layout..... | 35 |
| CPU Registers..... | 36 |
| CPU Registers of the 8051 Variants | 36 |
| CPU Registers of the Intel/Atmel WM 251 | 37 |
| Program Status Word (PSW) | 39 |
| Instruction Sets | 40 |
| Opcode Map | 64 |
| 8051 Instructions..... | 65 |
| Additional 251 Instructions..... | 66 |
| Additional 80C51MX Instructions via Prefix A5..... | 67 |
| Chapter 3. Writing Assembly Programs | 69 |
| Assembly Statements | 69 |
| Directives | 70 |
| Controls..... | 70 |
| Instructions..... | 70 |
| Comments | 71 |
| Symbols | 72 |
| Symbol Names | 72 |
| Labels..... | 73 |
| Operands..... | 74 |
| Special Assembler Symbols | 75 |
| Immediate Data | 76 |
| Memory Access..... | 76 |

Shaded directives and options are available only in AX51 and A251.

| | |
|---|-----------|
| DATA..... | 77 |
| BIT | 77 |
| EBIT (only on Intel/Atmel WM 251) | 78 |
| IDATA | 78 |
| EDATA (Intel/Atmel WM 251, Philips 80C51MX only) | 79 |
| XDATA..... | 80 |
| CODE and CONST | 80 |
| HDATA and HCONST | 81 |
| Program Addresses..... | 82 |
| Expressions and Operators..... | 84 |
| Numbers | 84 |
| Colon Notation for Numbers (A251 only) | 85 |
| Characters..... | 86 |
| Character Strings..... | 87 |
| Location Counter..... | 87 |
| Operators..... | 88 |
| Arithmetic Operators..... | 88 |
| Binary Operators..... | 88 |
| Relational Operators..... | 89 |
| Class Operators..... | 90 |
| Type Operators | 90 |
| Miscellaneous Operators..... | 91 |
| Operator Precedence..... | 92 |
| Expressions..... | 93 |
| Expression Classes..... | 93 |
| Relocatable Expressions..... | 95 |
| Simple Relocatable Expressions..... | 96 |
| Extended Relocatable Expressions..... | 97 |
| Examples with Expressions..... | 98 |
| Chapter 4. Assembler Directives | 99 |
| Introduction..... | 99 |
| Segment Directives | 102 |
| Location Counter..... | 102 |
| Generic Segments..... | 103 |
| Stack Segment..... | 104 |
| Absolute Segments..... | 105 |
| Default Segment..... | 105 |
| SEGMENT..... | 106 |
| RSEG..... | 110 |
| BSEG, CSEG, DSEG, ISEG, XSEG..... | 111 |
| Symbol Definition..... | 113 |
| EQU, SET | 113 |
| CODE, DATA, IDATA, XDATA..... | 114 |
| esfr, sfr, sfr16, sbit | 116 |
| LIT (AX51 & A251 only) | 117 |

Shaded directives and options are available only in AX51 and A251.

| | |
|---|------------|
| Memory Initialization | 119 |
| DB | 119 |
| DW | 120 |
| DD (AX51 & A251 only) | 121 |
| Reserving Memory..... | 122 |
| DBIT | 122 |
| DS | 123 |
| DSB (AX51 & A251 only) | 124 |
| DSW (AX51 & A251 only) | 125 |
| DSD (AX51 & A251 only) | 126 |
| Procedure Declaration (AX51 & A251 only) | 127 |
| PROC / ENDP (AX51 & A251 only) | 127 |
| LABEL (AX51 and A251 only) | 129 |
| Program Linkage..... | 130 |
| PUBLIC | 130 |
| EXTRN / EXTERN | 131 |
| NAME | 132 |
| Address Control..... | 133 |
| ORG | 133 |
| EVEN (AX51 and A251 only) | 134 |
| USING | 134 |
| Other Directives..... | 136 |
| END | 136 |
| __ERROR__ | 136 |
| Chapter 5. Assembler Macros..... | 137 |
| Standard Macro Directives | 139 |
| Defining a Macro | 140 |
| Parameters..... | 141 |
| Labels..... | 142 |
| Repeating Blocks | 144 |
| REPT | 144 |
| IRP | 145 |
| IRPC..... | 146 |
| Nested Definitions..... | 147 |
| Nested Repeating Blocks | 147 |
| Recursive Macros..... | 148 |
| Operators | 149 |
| NUL Operator | 150 |
| & Operator | 151 |
| < and > Operators | 152 |
| % Operator..... | 153 |
| ;; Operator | 154 |
| ! Operator..... | 154 |
| Invoking a Macro..... | 155 |
| C Macros..... | 156 |

Shaded directives and options are available only in AX51 and A251.

| | |
|---|------------|
| C Macro Preprocessor Directives | 157 |
| Stringize Operator | 158 |
| Token-pasting Operator | 159 |
| Predefined C Macro Constants | 160 |
| Examples with C Macros | 161 |
| C Preprocessor Side Effects | 162 |
| Chapter 6. Macro Processing Language | 163 |
| Overview | 163 |
| Creating and Calling MPL Macros | 164 |
| Creating Parameterless Macros | 164 |
| MPL Macros with Parameters | 166 |
| Local Symbols List | 169 |
| Macro Processor Language Functions | 170 |
| Comment Function | 170 |
| Escape Function | 171 |
| Bracket Function | 172 |
| METACHAR Function | 173 |
| Numbers and Expressions | 174 |
| Numbers | 175 |
| Character Strings | 176 |
| SET Function | 177 |
| EVAL Function | 178 |
| Logical Expressions and String Comparison | 179 |
| Conditional MPL Processing | 180 |
| IF Function | 180 |
| WHILE Function | 181 |
| REPEAT Function | 182 |
| EXIT Function | 183 |
| String Manipulation Functions | 184 |
| LEN Function | 184 |
| SUBSTR Function | 185 |
| MATCH Function | 186 |
| Console I/O Functions | 187 |
| Advanced Macro Processing | 188 |
| Literal Delimiters | 189 |
| Blank Delimiters | 190 |
| Identifier Delimiters | 191 |
| Literal and Normal Mode | 192 |
| MACRO Errors | 193 |
| Chapter 7. Invocation and Controls | 195 |
| Environment Settings | 195 |
| Running Ax51 | 196 |
| ERRORLEVEL | 197 |
| Output Files | 197 |
| Assembler Controls | 197 |

Shaded directives and options are available only in AX51 and A251.

| | |
|--|------------|
| CASE (AX51 and A251 only) | 200 |
| COND / NOCOND | 201 |
| DATE | 202 |
| DEBUG | 203 |
| EJECT | 204 |
| ERRORPRINT | 205 |
| FIXDRK (A251 only) | 206 |
| GEN / NOGEN | 207 |
| INCDIR | 208 |
| INCLUDE | 209 |
| INTR2 (A251 only) | 210 |
| LIST / NOLIST | 211 |
| MOD51, MOD_CONT, MOD_MX51 (AX51 only) | 212 |
| MODSRC (A251 only) | 213 |
| MPL | 214 |
| NOLINES | 215 |
| NOMACRO | 216 |
| NOMOD51 | 217 |
| NOSYMBOLS | 218 |
| OBJECT / NOOBJECT | 219 |
| PAGELength, PAGEWIDTH | 220 |
| PRINT / NOPRINT | 221 |
| REGISTERBANK / NOREGISTERBANK | 222 |
| REGUSE | 223 |
| SAVE / RESTORE | 224 |
| SYMLIST / NOSYMLIST | 225 |
| TITLE | 226 |
| XREF | 227 |
| Controls for Conditional Assembly | 228 |
| Conditional Assembly Controls | 229 |
| Predefined Constants (A251 only) | 230 |
| SET | 231 |
| RESET | 232 |
| IF | 233 |
| ELSEIF | 234 |
| ELSE | 235 |
| ENDIF | 236 |
| Chapter 8. Error Messages | 237 |
| Fatal Errors | 237 |
| Non-Fatal Errors | 241 |
| Chapter 9. Linker/Locator | 255 |
| Overview | 257 |
| Combining Program Modules | 258 |
| Segment Naming Conventions | 258 |
| Combining Segments | 259 |
| Shaded directives and options are available only in AX51 and A251. | |

| | |
|--|-----|
| Locating Segments | 260 |
| Overlaying Data Memory | 261 |
| Resolving External References | 261 |
| Absolute Address Calculation | 262 |
| Generating an Absolute Object File | 262 |
| Generating a Listing File | 263 |
| Bank Switching | 264 |
| Using RTX51, RTX251, and RTX51 Tiny | 265 |
| Linking Programs | 266 |
| Command Line Examples | 268 |
| Control Linker Input with μ Vision2 | 269 |
| ERRORLEVEL | 269 |
| Output File | 269 |
| Linker/Locater Controls | 270 |
| BL51 Controls | 271 |
| LX51 and L251 Controls | 272 |
| Locating Programs to Physical Memory | 273 |
| Classic 8051 | 273 |
| Classic 8051 without Code Banking | 274 |
| Classic 8051 with Code Banking | 275 |
| Extended 8051 Variants | 276 |
| Philips 80C51MX | 277 |
| Intel/Atmel WM 251 | 278 |
| Data Overlaying | 280 |
| Program and Data Segments of Functions | 281 |
| Using the Overlay Control | 282 |
| Disable Data Overlaying | 283 |
| Pointer to a Function as Function Argument | 284 |
| Pointer to a Function in Arrays or Tables | 286 |
| Tips and Tricks for Program Locating | 289 |
| Locate Segments with Wildcards | 289 |
| Special ROM Handling (LX51 & L251 only) | 290 |
| Segment and Class Information (LX51 & L251 only) | 291 |
| Use RAM for the 251 Memory Class NCONST | 292 |
| Bank Switching | 293 |
| Common Code Area | 293 |
| Code Bank Areas | 294 |
| Optimum Program Structure with Bank Switching | 294 |
| Program Code in Bank and Common Areas | 295 |
| Segments in Bank Areas | 296 |
| Bank Switching Configuration | 297 |
| Configuration Examples | 299 |
| Control Summary | 305 |
| Listing File Controls | 306 |
| DISABLEWARNING | 307 |
| IXREF | 308 |

Shaded directives and options are available only in AX51 and A251.

| | |
|--|-----|
| NOCOMMENTS | 309 |
| NOLINES | 310 |
| NOMAP | 311 |
| NOPUBLICS | 312 |
| NOSYMBOLS | 313 |
| PAGELNGTH / PAGEWIDTH | 314 |
| PRINT / NOPRINT | 315 |
| PRINTCONTROLS | 316 |
| PURGE | 317 |
| WARNINGLEVEL | 318 |
| Example Listing File | 319 |
| Output File Controls | 321 |
| ASSIGN | 322 |
| IBANKING | 323 |
| NAME | 324 |
| NOAJMP | 325 |
| NODEBUGLINES, NODEBUGPUBLICS, NODEBUGSYMBOLS | 326 |
| NOINDIRECTCALL | 327 |
| NOJMPTAB | 328 |
| NOTYPE | 329 |
| OBJECTCONTROLS | 330 |
| Segment and Memory Location Controls | 331 |
| BANKAREA | 332 |
| BANKx | 333 |
| BIT | 334 |
| CLASSES | 336 |
| CODE | 338 |
| DATA | 339 |
| IDATA | 340 |
| NOSORTSIZE | 341 |
| PDATA | 342 |
| PRECEDE | 343 |
| RAMSIZE | 344 |
| RESERVE | 345 |
| SEGMENTS | 346 |
| SEGSIZE | 348 |
| STACK | 349 |
| XDATA | 350 |
| High-Level Language Controls | 351 |
| NODEFAULTLIBRARY | 352 |
| NOOVERLAY | 353 |
| OVERLAY | 354 |
| RECURSIONS | 356 |
| REGFILE | 357 |
| RTX251, RTX51, RTX51TINY | 358 |
| SPEEDOVL | 359 |

Shaded directives and options are available only in AX51 and A251.

| | |
|--|------------|
| Error Messages..... | 360 |
| Warnings | 360 |
| Non-Fatal Errors..... | 365 |
| Fatal Errors..... | 370 |
| Exceptions | 375 |
| Chapter 10. Library Manager | 377 |
| Using LIBx51 | 378 |
| Interactive Mode | 378 |
| Create Library within μ Vision2..... | 378 |
| Command Summary..... | 379 |
| Creating a Library | 380 |
| Adding or Replacing Object Modules..... | 381 |
| Removing Object Modules..... | 382 |
| Extracting Object Modules..... | 382 |
| Listing Library Contents..... | 383 |
| Error Messages..... | 384 |
| Fatal Errors..... | 384 |
| Errors..... | 385 |
| Chapter 11. Object-Hex Converter | 387 |
| Using OHx51 | 388 |
| OHx51 Command Line Examples | 389 |
| Creating HEX Files for Banked Applications | 389 |
| OHx51 Error Messages | 390 |
| Using OC51 | 392 |
| OC51 Error Messages | 393 |
| Intel HEX File Format | 394 |
| Record Format..... | 394 |
| Data Record..... | 395 |
| End-of-File (EOF) Record..... | 395 |
| Extended 8086 Segment Record | 396 |
| Extended Linear Address Record..... | 396 |
| Example Intel HEX File | 397 |
| Appendix A. Application Examples..... | 399 |
| ASM – Assembler Example | 399 |
| Using A51 and BL51..... | 400 |
| Using AX51 and LX51..... | 401 |
| Using A251 and L251 | 401 |
| CSAMPLE – C Compiler Example..... | 402 |
| Using C51 and BL51 | 402 |
| Using C51 and LX51..... | 403 |
| Using C251 and L251..... | 403 |
| BANK_EX1 – Code Banking with C51..... | 404 |
| Using C51 and BL51 | 405 |
| Using C51 and LX51..... | 406 |

Shaded directives and options are available only in AX51 and A251.

| | |
|---|------------|
| BANK_EX2 – Banking with Constants..... | 407 |
| Using C51 and BL51..... | 407 |
| Using C51 and LX51 | 408 |
| BANK_EX3 – Code Banking with PL/M-51 | 408 |
| Using BL51..... | 409 |
| Using C51 and LX51 | 410 |
| Philips 80C51MX – Assembler Example | 410 |
| Philips 80C51MX – C Compiler Example..... | 411 |
| Appendix B. Reserved Symbols | 413 |
| Appendix C. Listing File Format..... | 415 |
| Assembler Listing File Format..... | 415 |
| Listing File Heading | 417 |
| Source Listing | 418 |
| Macro / Include File / Save Stack Format..... | 419 |
| Symbol Table..... | 419 |
| Listing File Trailer | 421 |
| Appendix D. Assembler Differences..... | 423 |
| Differences Between A51 and A251/AX51 | 423 |
| Differences between A51 and ASM51..... | 424 |
| Differences between A251/AX51 & ASM51 | 425 |
| Glossary..... | 427 |
| Index..... | 437 |

Shaded directives and options are available only in AX51 and A251.

Chapter 1. Introduction

1

This manual describes the macro assemblers and utilities for the classic 8051, extended 8051, and 251 microcontroller families and explains the process of developing software in assembly language for these microcontroller families.

A brief overview of the classic 8051, the extended 8051, and the 251 architectures may be found in “Chapter 2. Architecture Overview” on page 27. In this overview, the differences between the classic 8051, the extended 8051 variants and the 251 processors are described. For the most complete information about the microcontroller architecture refer to the hardware reference manual of the microcontroller derivative that your are using.

For optimum support of the different 8051 and 251 variants, Keil provides the following development tools:

| Development Tools | Support Microcontrollers, Description |
|---|---|
| A51 Macro Assembler BL51 Linker/Locater LIB51 Library Manager | Development Tools for classic 8051 . Includes support for 32 x 64KB code banks. |
| AX51 Macro Assembler LX51 Extended Linker/Locater LIBX51 Library Manager | Development Tools for classic and extended 8051 versions (Philips 80C51MX, Dallas 390, etc.) Supports up to 16MB code and xdata memory. |
| A251 Macro Assembler L251 Linker/Locater LIB251 Library Manager | Development Tools for Intel/Atmel WM 251 . |

The AX51 and A251 assemblers are supersets of the A51 assembler. This user’s guide therefore covers all development tools variants. Whenever a feature or an option is available in one specific tool chain only, it is clearly marked.

For general reference to all tool variants and microcontroller architectures the terms listed in the following table are used:

| Term | Refers to ... |
|---------------------------------------|--|
| Ax51 Macro Assembler | A51, AX51 and A251 Macro Assembler |
| Cx51 Compiler | C51, CX51 and C251 ANSI C Compiler |
| Lx51 Linker/Locator | BL51, LX51 and L251 Linker/Locator |
| LIBx51 Library Manager | LIB51, LIBX51 and LIB251 Library Manager |
| OHx51 Object-Hex Converter | OH51, OHX51 and OH251 Object-Hex Converter |
| x51 Architecture or x51 Device | All classic 8051, extended 8051 and 251 device variants. |

1

How to Develop A Program

This section presents an overview of the Ax51 macro assembler, Lx51 linker/locater and how it is used.

What is an Assembler?

An assembler is a software tool designed to simplify the task of writing computer programs. It translates symbolic code into executable object code. This object code may then be programmed into a microcontroller and executed. Assembly language programs translate directly into CPU instructions which instruct the processor what operations to perform. Therefore, to effectively write assembly programs, you should be familiar with both the microcomputer architecture and the assembly language.

Assembly language operation codes (mnemonics) are easily remembered (MOV for move instructions, ADD for addition, and so on). You can also symbolically express addresses and values referenced in the operand field of instructions. Since you assign these names, you can make them as meaningful as the mnemonics for the instructions. For example, if your program must manipulate a date as data, you can assign it the symbolic name DATE. If your program contains a set of instructions used as a timing loop (a set of instructions executed repeatedly until a specific amount of time has passed), you can name the instruction group `TIMER_LOOP`.

An assembly program has three constituent parts:

- Machine instructions
- Assembler directives
- Assembler controls

A machine instruction is a machine code that can be executed by the machine. Detailed discussion of the machine instructions can be found in the hardware manuals of the 8051 or derivative microcontroller. Appendix A provides an overview about machine instructions.

Assembler directives are used to define the program structure and symbols, and generate non-executable code (data, messages, etc.). Refer to “Chapter 4. Assembler Directives” on page 99 for details on all of the assembler directives.

Assembler controls set the assembly modes and direct the assembly flow. “Chapter 7. Invocation and Controls” on page 195 contains a comprehensive guide to all the assembler controls.

1

Modular Programming

Many programs are too long or complex to write as a single unit. Programming becomes much simpler when the code is divided into small functional units. Modular programs are usually easier to code, debug, and change than monolithic programs.

The modular approach to programming is similar to the design of hardware that contains numerous circuits. The device or program is logically divided into “black boxes” with specific inputs and outputs. Once the interfaces between the units have been defined, the detailed design of each unit can proceed separately.

The benefits of modular programming are:

Efficient Program Development: programs can be developed more quickly with the modular approach since small subprograms are easier to understand, design, and test than large programs. With the module inputs and outputs defined, the programmer can supply the needed input and verify the correctness of the module by examining the output. The separate modules are then linked and located by the linker into an absolute executable single program module. Finally, the complete module is tested.

Multiple Use of Subprograms: code written for one program is often useful in others. Modular programming allows these sections to be saved for future use. Because the code is relocatable, saved modules can be linked to any program which fulfills their input and output requirements. With monolithic programming, such sections of code are buried inside the program and are not so available for use by other programs.

Ease of Debugging and Modifying: modular programs are generally easier to debug than monolithic programs. Because of the well defined module interfaces of the program, problems can be isolated to specific modules. Once the faulty

1

module has been identified, fixing the problem is considerably simpler. When a program must be modified, modular programming simplifies the job. You can link new or debugged modules to an existing program with the confidence that the rest of the program will not change.

The following figure shows an overview of the steps involved in creating a program for the x51.

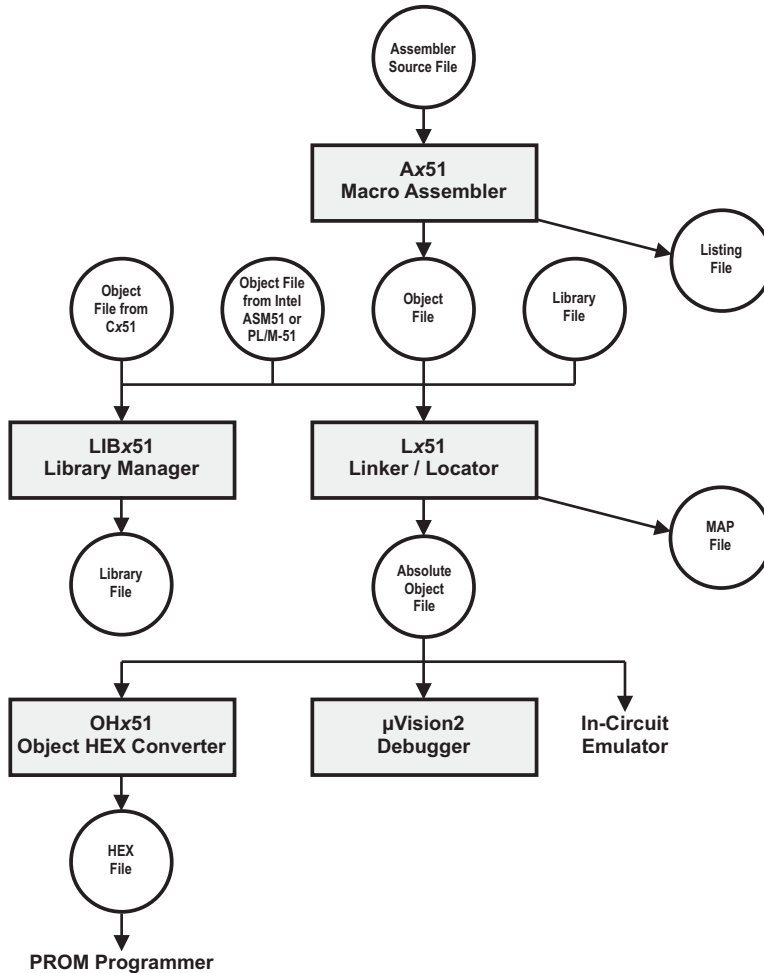

Modular Program Development Process

1

This section is a brief discussion of the program development process with the relocatable **Ax51** assembler, **Lx51** Linker/Locator, and the **OHx51** code conversion program.

Segments, Modules, and Programs

In the initial design stages, the tasks to be performed by the program are defined, and then partitioned into subprograms. Here are brief introductions to the kinds of subprograms used with the **Ax51** assembler and **Lx51** linker/locator.

A segment is a block of code or data memory. A segment may be relocatable or absolute. A relocatable segment has a name, type, and other attributes. Segments with the same name, from different modules, are considered part of the same segment and are called *partial segments*. Several *partial segments* with the same name are combined into one segment by the **Lx51** linker/locator. An absolute segment cannot be combined with other segments.

A module contains one or more segments or partial segments. A module is a source code unit that can be translated independently. It contains all symbol definitions that are used within the module. A module might be a single ASCII text file that is created by any standard text editor. However, with you may use the *include* assembler directive to merge several text files. The **Ax51** assembler translates a source file into an object file. Each object file is one module.

After assembly of all modules of the program, **Lx51** processes the object module files. The **Lx51** linker/locator assigns absolute memory locations to all the relocatable segments, combining segments with the same name and type. **Lx51** also resolves all references between modules. **Lx51** outputs an absolute object module file with the completed program, and a map file that lists the results of the link/locate process.

1

Translate and Link Process

Typically you will use the **Ax51** assembler and the tools within the μ Vision2 IDE. For more information on using the μ Vision2 IDE refer to the User's Guide *μ Vision2: Getting Started for 8051*.

However, you may invoke the **Ax51** assembler also from the command line. Simply type the name of the assembler version that you want to use, for example **A51** at the Windows command prompt. On this command line, you must include the name of the assembler source file to be translated, as well as any other necessary control directives required to translate your source file. Example:

```
A51 DEMO.A51
```

The assembler output for this command line is:

```
A51 MACRO ASSEMBLER V6.00  
ASSEMBLY COMPLETE. 0 WARNING(S), 0 ERROR(S)
```

After assembly of all your program modules, the object modules are linked and all variables and addresses are resolved and located into an executable program by the **Lx51** linker. The following example shows a simple command line for the linker:

```
BL51 DEMO.OBJ, PRINT.OBJ
```

The linker generates an absolute object file as well as a map file that contains detailed statistic information and screen messages. The output of the linker is:

```
BL51 LINKER/LOCATER V4.00  
LINK/LOCATE RUN COMPLETE. 0 WARNING(S), 0 ERROR(S)
```

Then you might convert the executable program into an Intel HEX file for PROM programming. This is done with the **OHx51** hex conversion utility with the following invocation:

```
OH51 DEMO
```

The output of the hex conversion utility is:

```
OBJECT TO HEX FILE CONVERTER OH51 V2.40  
GENERATING INTEL HEX FILE: DEMO.HEX  
OBJECT TO HEX CONVERSION COMPLETED.
```

An example listing file generated by the assembler is shown on the following page.

```

A51 MACRO ASSEMBLER ASSEMBLER DEMO PROGRAM                                07/07/2000 18:32:30 PAGE 1
MACRO ASSEMBLER A51 V6.01
OBJECT MODULE PLACED IN demo.OBJ
ASSEMBLER INVOKED BY: C:\KEIL\C51\BIN\A51.EXE DEMO.A51 DEBUG

LOC  OBJ                LINE      SOURCE
                                1      $title (ASSEMBLER DEMO PROGRAM)
                                2      ; A simple Assembler Module for Demonstration
                                3
                                4      ; Symbol Definition
000D   5      CR      EQU 13      ; Carriage?Return
000A   6      LF      EQU 10      ; Line?Feed
                                7
                                8      ; Segment Definition
                                9      ?PR?DEMO SEGMENT CODE ; Program Part
                               10      ?CO?DEMO SEGMENT CODE ; Constant Part
                               11
                               12      ; Extern Definition
                               13      EXTRN CODE (PRINTS, DEMO)
                               14
                               15      ; The Program Start
                               16      CSEG AT 0      ; Reset Vector
0000 020000  F      17      JMP      Start
                               18
-----
                               19      RSEG ?PR?DEMO ; Program Part
0000 900000  F      20      START: MOV  DPTR,#Txt ; Demo Text
0003 120000  F      21      CALL  PRINTS ; Print String
                               22      ;
0006 020000  F      23      JMP   DEMO      ; Demo Program
                               24
                               25      ; The Text Constants
-----
                               26      RSEG ?CO?DEMO ; Constant Part
0000 48656C6C 27      Txt:  DB   'Hello World',CR,LF,0
0004 6F20576F
0008 726C640D
000C 0A00
                               28
                               29      END          ; End of Module

SYMBOL TABLE LISTING
-----
N A M E                T Y P E  V A L U E  A T T R I B U T E S
?CO?DEMO . . . . . C SEG      000EH          REL=UNIT
?PR?DEMO . . . . . C SEG      0009H          REL=UNIT
CR . . . . . N NUMB     000DH          A
DEMO . . . . . C ADDR     -----        EXT
LF . . . . . N NUMB     000AH          A
PRINTS . . . . . C ADDR     -----        EXT
START. . . . . C ADDR     0000H          R      SEG=?PR?DEMO
TXT. . . . . C ADDR     0000H          R      SEG=?CO?DEMO

REGISTER BANK(S) USED: 0
ASSEMBLY COMPLETE. 0 WARNING(S), 0 ERROR(S)

```

1

Filename Extensions

Typically, the filename extension is used to indicate the contents of each file. The following table lists the file name extensions that are used in the 8051 tool chain.

| Extension | Content and Description |
|----------------------|--|
| .A51 .ASM .SRC | Source code file: contains ASCII text that is the input for the Ax51 assembler. |
| .C .C51 | C source code file: contains ASCII text that is the input for the Cx51 ANSI C compiler. |
| .INC .H | Include file: contains ASCII text that is merged into an source code file with the include directive. Also these files are input files for Ax51 or Cx51 . |
| .OBJ | Relocatable object file: is the output of the Ax51 or Cx51 that contains the program code and control information. Several relocatable object files are typically input files for the Lx51 Linker/Locater. |
| .LST | Listing object file: is generated by Ax51 or Cx51 to document the translation process. A listing file typically contains the ASCII program text and diagnostic information about the source module. Appendix F describes the format of the Ax51 listing file. |
| . (none) .ABS | Absolute object file: is the output of the Lx51 . Typically it is a complete program that can be executed on the x51 CPU. |
| .M51 .MAP | Linker map file: is the listing file generated from Lx51 . A map file contains information about the memory usage and other statistic information. |
| .HEX .H86 | Hex file: is the output file of the OHx51 object hex converter in Intel HEX file format. HEX files are used as input file for PROM programmers or other utility programs. |

Program Template File

The following code template contains guidelines and hints on how to write your own assembly modules. This template file `TEMPLATE.A51` is provided in the folder `\C51\ASM` or `\C251\ASM`.

1

```

$NOMOD51          ; disable predefined 8051 registers
#include <reg52.h> // include CPU definition file (for example, 8052)

;-----
; Change names in lowercase to suit your needs.
;
; This assembly template gives you an idea of how to use the A251/A51
; Assembler. You are not required to build each module this way-this is only
; an example.
;
; All entries except the END statement at the End Of File are optional.
;
; If you use this template, make sure you remove any unused segment declarations,
; as well as unused variable space and assembly instructions.
;
; This file cannot provide for every possible use of the A251/A51 Assembler.
;-----

;-----
; Module name (optional)
;-----
NAME          module_name

;-----
; Here, you may import symbols form other modules.
;-----
EXTRN  CODE   (code_symbol)   ; May be a subroutine entry declared in
                               ; CODE segments or with CODE directive.

EXTRN  DATA  (data_symbol)   ; May be any symbol declared in DATA segments
                               ; segments or with DATA directive.

EXTRN  BIT    (bit_symbol)    ; May be any symbol declared in BIT segments
                               ; or with BIT directive.

EXTRN  XDATA  (xdata_symbol)  ; May be any symbol declared in XDATA segments
                               ; or with XDATA directive.

EXTRN  NUMBER (typeless_symbol); May be any symbol declared with EQU or SET
                               ; directive

;-----
; You may include more than one symbol in an EXTRN statement.
;-----
EXTRN  CODE (sub_routine1, sub_routine2), DATA (variable_1)

;-----
; Force a page break in the listing file.
;-----
$EJECT

;-----
; Here, you may export symbols to other modules.
;-----
PUBLIC  data_variable
PUBLIC  code_entry
PUBLIC  typeless_number
PUBLIC  xdata_variable
PUBLIC  bit_variable

```

```

;-----
; You may include more than one symbol in a PUBLIC statement.
;-----
PUBLIC data_variable1, code_table, typeless_num1, xdata_variable1

;-----
; Put the STACK segment in the main module.
;-----
?STACK          SEGMENT IDATA          ; ?STACK goes into IDATA RAM.
                 RSEG    ?STACK        ; switch to ?STACK segment.
                 DS      5             ; reserve your stack space
                                     ; 5 bytes in this example.

$EJECT

;-----
; Put segment and variable declarations here.
;-----

;-----
; DATA SEGMENT--Reserves space in DATA RAM--Delete this segment if not used.
;-----
data_seg_name   SEGMENT DATA          ; segment for DATA RAM.
                 RSEG    data_seg_name ; switch to this data segment
data_variable:  DS      1             ; reserve 1 Bytes for data_variable
data_variable1: DS      2             ; reserve 2 Bytes for data_variable1

;-----
; XDATA SEGMENT--Reserves space in XDATA RAM--Delete this segment if not used.
;-----
xdata_seg_name  SEGMENT XDATA         ; segment for XDATA RAM
                 RSEG    xdata_seg_name ; switch to this xdata segment
xdata_variable: DS      1             ; reserve 1 Bytes for xdata_variable
xdata_array:    DS      500          ; reserve 500 Bytes for xdata_array

;-----
; INPAGE XDATA SEGMENT--Reserves space in XDATA RAM page (page size: 256 Bytes)
; INPAGE segments are useful for @R0 addressing methodes.
; Delete this segment if not used.
;-----
page_xdata_seg  SEGMENT XDATA INPAGE  ; INPAGE segment for XDATA RAM
                 RSEG    xdata_seg_name ; switch to this xdata segment
xdata_variable1:DS      1             ; reserve 1 Bytes for xdata_variable1

;-----
; ABSOLUTE XDATA SEGMENT--Reserves space in XDATA RAM at absolute addresses.
; ABSOLUTE segments are useful for memory mapped I/O.
; Delete this segment if not used.
;-----
XIO:            XSEG    AT 8000H       ; switch absolute XDATA segment @ 8000H
                 DS      1             ; reserve 1 Bytes for XIO port
XCONFIG:        DS      1             ; reserve 1 Bytes for XCONFIG port

;-----
; BIT SEGMENT--Reserves space in BIT RAM--Delete segment if not used.
;-----
bit_seg_name    SEGMENT BIT           ; segment for BIT RAM.
                 RSEG    bit_seg_name ; switch to this bit segment
bit_variable:   DBIT    1             ; reserve 1 Bit for bit_variable
bit_variable1:  DBIT    4             ; reserve 4 Bits for bit_variable1

;-----
; Add constant (typeless) numbers here.
;-----
typeless_number EQU    0DH           ; assign 0D hex
typeless_num1   EQU    typeless_number-8 ; evaluate typeless_num1

$EJECT

```



```

;-----
; Provide an LJMP to start at the reset address (address 0) in the main module.
; You may use this style for interrupt service routines.
;-----
                CSEG    AT    0        ; absolute Segment at Address 0
                LJMP   start          ; reset location (jump to start)
;-----
; CODE SEGMENT--Reserves space in CODE ROM for assembler instructions.
;-----
code_seg_name  SEGMENT CODE

                RSEG    code_seg_name ; switch to this code segment

                USING  0              ; state register_bank used
                                        ; for the following program code.

start:         MOV     SP,#?STACK-1   ; assign stack at beginning
;-----
; Insert your assembly program here. Note, the code below is non-functional.
;-----
repeat_label:  ORL     IE,#82H        ; enable interrupt system (timer 0)
                SETB  TR0          ; enable timer 0
                MOV   A,data_symbol
                ADD   A,#typeless_symbol
                CALL  code_symbol
                MOV   DPTR,#xdata_symbol
                MOVX  A,@DPTR
                MOV   R1,A
                PUSH  AR1
                CALL  sub_routine1
                POP   AR1
                ADD   A,R1
                JMP   repeat_label

code_entry:    CALL  code_symbol
                RET

code_table:    DW     repeat_label
                DW     code_entry
                DB     typeless_number
                DB     0

$EJECT

;-----
; To include an interrupt service routine, provide an LJMP to the ISR at the
; interrupt vector address.
;-----
                CSEG    AT  0BH      ; 0BH is address for Timer 0 interrupt
                LJMP   timer0int
;-----
; Give each interrupt function its own code segment.
;-----
int0_code_seg  SEGMENT CODE          ; segment for interrupt function
                RSEG   int0_code_seg ; switch to this code segment
                USING  1            ; register bank for interrupt routine

timer0int:    PUSH   PSW
                MOV   PSW,#08H      ; register bank 1
                PUSH  ACC
                MOV   R1,data_variable
                MOV   DPTR,#xdata_variable
                MOVX  A,@DPTR
                ADD   A,R1
                MOV   data_variable1,A
                CLR   A
                ADD   A,#0

```

1

```
MOV    data_variable1+1,A
POP    ACC
POP    PSW
RETI
```

```
-----
; The END directive is ALWAYS required.
-----
```

```
END          ; End Of File
```

Chapter 2. Architecture Overview

This chapter gives you an overview of the 8051 architecture and the variants of the 8051. It reviews the memory layout of the classic 8051, extended 8051 variants, the Philips 80C51MX, and the 251 architecture. Also described are the register sets and the CPU instructions of the various CPU variants.

2

Memory Classes and Memory Layout

This section introduces the different memory classes (also known as memory types) that are used during programming of the 8051 and variants. Memory classes are used to identify the different physical memory regions of the microcontroller architecture that can be represented in a memory layout.

An overview of the different physical memory regions in an **x51** system is provided below:

Program Memory: in the classic 8051 this is a 64KB space that is called CODE. This region is typically a ROM space that is used for program code and constants. With the BL51 you may expand the physical program code memory to 32 code banks with 64KB each. Constants are fetched with the MOVC instruction. In extended 8051 variants and the 251 you may have program memory of up to 16MB that is called ECODE and HCONST.

Internal Data Memory: in the classic 8051 this is the on-chip RAM space with a maximum of 256 Bytes that contains register banks, BIT space, direct addressable DATA space, and indirect addressable IDATA space. This region should be used for frequently used variables. In the 80C51MX and the 251 this space is expanded to up to 64KB with an EDATA space.

External Data Memory: in classic 8051 devices this area, called XDATA, is off-chip RAM with a space of up to 64KB. However several new 8051 devices have additional on-chip RAM that is mapped into the XDATA space. Usually you need to enable this additional on-chip RAM via dedicated SFR registers. In extended variants and the 251 you may have external data memory of up to 16MB that is called HDATA.

Classic 8051

The following table shows the memory classes used for programming the classic 8051 architecture. These memory classes are available when you are using the A51 macro assembler and the **BL51** linker/locater.

| Memory Class | Address Range | Description |
|-------------------------------------|--|---|
| DATA | D:00 – D:7F | Direct addressable on-chip RAM. |
| BIT | D:20 – D:2F | bit-addressable RAM; accessed bit instructions. |
| IDATA | I:00 – I:FF | Indirect addressable on-chip RAM; can be accessed with @R0 or @R1. |
| XDATA | X:0000 – X:FFFF | 64 KB RAM (read/write access). Accessed with MOVX instruction. |
| CODE | C:0000 – C:FFFF | 64 KB ROM (only read access possible). Used for executable code or constants. |
| BANK 0 ... BANK 31 | B0:0000 – B0:FFFF B31:0000 – B31:FFFF | Code Banks for expanding the program code space to 32 x 64KB ROM. |

NOTE

The memory prefix D: I: X: C: B0: .. B31: cannot be used at Ax51 assembler or BL51 linker/locater level. The memory prefixes are only listed for better understanding. Several Debugging tools, for example the μ Vision2 Debugger, are using memory prefixes to identify the memory class of the address.

Classic 8051 Memory Layout

The classic 8051 memory layout, shown in the following figure, is familiar to 8051 users the world over.

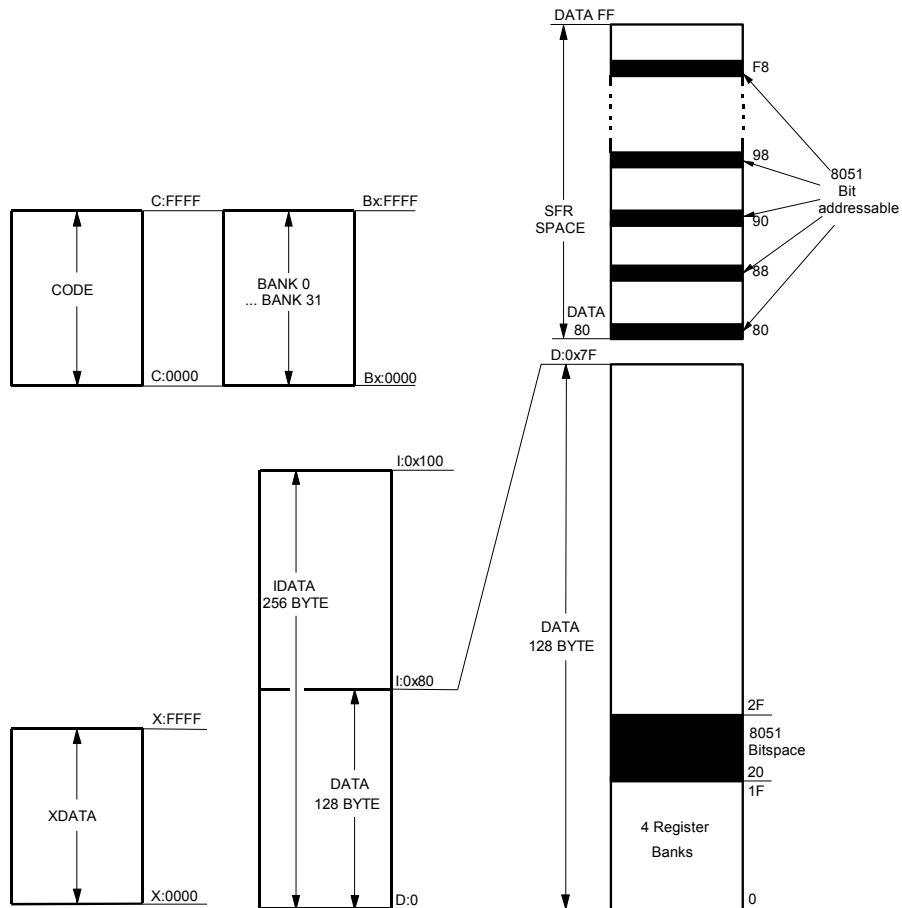

The memory code banks overlap the CODE space. The size of the code banks is selected with the **Lx51** directive **BANKAREA**.

Extended 8051 Variants

Several new variants of the 8051 extend the code and/or xdata space of the classic 8051 with address extension registers. The following table shows the memory classes used for programming the extended 8051 devices. These memory classes are available for classic 8051 devices when you are using memory banking with the LX51 linker/locator. In addition to the code banking known from the BL51 linker/locator, the LX51 linker/locator supports also data banking for xdata and code areas with standard 8051 devices.

| Memory Class | Address Range | Description |
|-------------------------------------|--|---|
| DATA | D:00 – D:7F | Direct addressable on-chip RAM. |
| BIT | D:20 – D:2F | bit-addressable RAM; accessed bit instructions. |
| IDATA | I:00 – I:FF | Indirect addressable on-chip RAM; can be accessed with @R0 or @R1. |
| XDATA | X:0000 – X:FFFF | 64 KB RAM (read/write access). Accessed with MOVX instruction. |
| HDATA | X:0000 – X:FFFFFF | 16 MB RAM (read/write access). Accessed with MOVX instruction and extended DPTR. |
| CODE | C:0000 – C:FFFF | 64 KB ROM (only read access possible). Used for executable code or constants. |
| ECODE | C:0000 – C:FFFFFF | 16 MB ROM (only read access possible). Used for constants. In some modes of the Dallas 390 architecture also program execution is possible. |
| BANK 0 ... BANK 31 | B0:0000 – B0:FFFF B31:0000 – B31:FFFF | Code Banks for expanding the program code space to 32 x 64KB ROM. |

NOTES

The memory prefixes D: I: X: C: B0: .. B31: cannot be used at Ax51 assembler level. The memory prefix is only listed for better understanding. The Lx51 linker/locator and several Debugging tools, for example the μ Vision2 Debugger, are using memory prefixes to identify the memory class of the address.

If you are using the Dallas 390 contiguous mode the address space for CODE can be C:0000 - C:0xFFFFF.

Extended 8051 Memory Layout

The extended 8051 memory layout, shown in the following figure, expands the address space for variables to a maximum of 16MB.

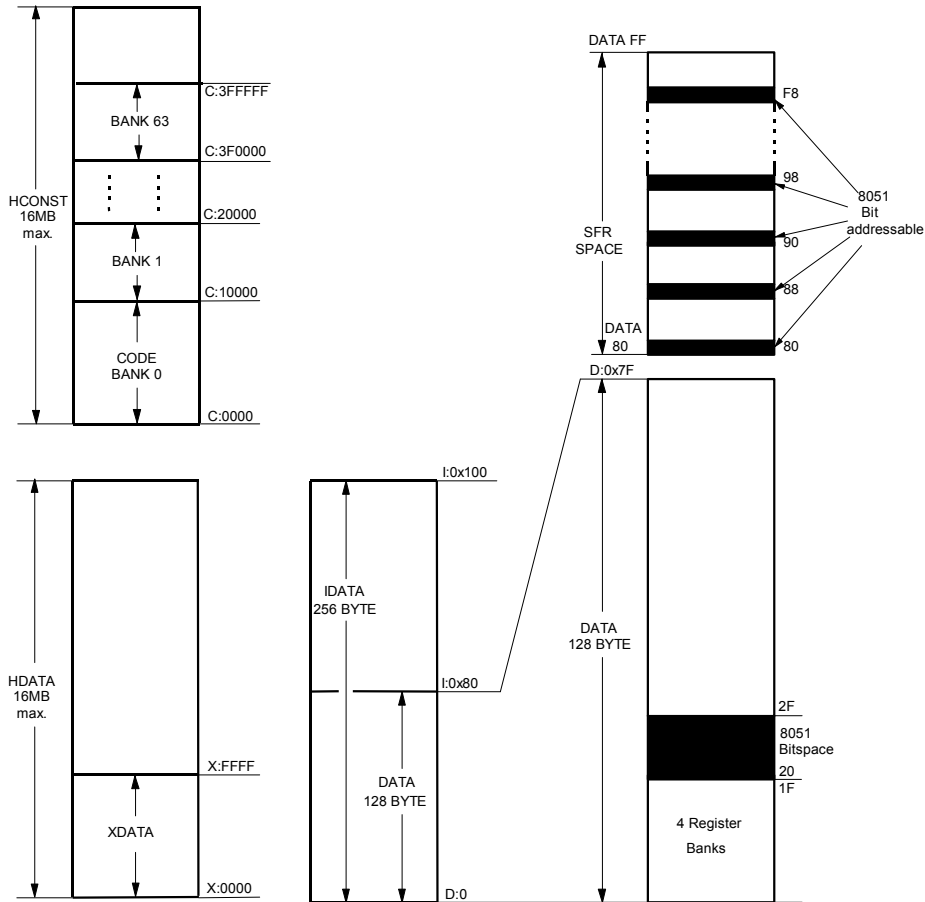

In several variants the DPTR register is expanded to a 24-bit register with an **DPX** SFR. For example, the Dallas 390 provides new operating modes where this addressing is enabled. You may even use the HCONST and HDATA memory classes with classic 8051 devices by using the memory banking available in LX51.

Philips 80C51MX

The Philips 80C51MX provides a unified 16 MB address space. New instructions can access up to 16MB memory whereby CODE and XDATA space are mapped into one single address space. The stack pointer can be configured as 16-Bit stack pointer that addresses the on-chip RAM area in the EDATA memory class. The following table shows the memory classes used for programming the 80C51MX architecture. These memory classes are available when you are using the AX51 macro assembler and the LX51 linker/locater.

| Memory Class | Address Range | Description |
|-------------------------------------|---|--|
| DATA | 7F:0000 – 7F:007F | Direct addressable on-chip RAM. |
| BIT | 7F:0020 – 7F:002F | Bit-addressable RAM; accessed bit instructions. |
| IDATA | 7F:0000 – 7F:00FF | Indirect addressable on-chip RAM; can be accessed with @R0 or @R1. |
| EDATA | 7F:0000 – 7F:FFFF | Complete on-chip RAM; can be used as stack space or can be accessed with @PR0 or @PR1. |
| XDATA | 00:0000 – 00:FFFF | 64 KB RAM (read/write access). Accessed with MOVX instruction. |
| HDATA | 00:0000 – 7F:FFFF | 8 MB RAM (read/write access). Accessed with MOVX instruction and extended DPTR. |
| CODE | 80:0000 – 80:FFFF | Classic 8051 compatible 64 KB ROM (only read access possible). Used for executable code or constants. |
| ECODE | 80:0000 – 80:FFFF | 8 MB ROM (only read access possible). |
| HCONST | 80:0000 – 80:FFFF | 8 MB ROM. Same as ECODE, this class is used by the CX51 Compiler for constants. |
| BANK 0 ... BANK 63 | 80:0000 – 0xBF:FFFF B0:0000 – B63:FFFF | Used by the CX51 Compiler to expand the program memory to more than 64KB. Refer to “Philips 80C51MX” on page 277 for more information. |

NOTES

Colons are used to improve the readability only. The addresses are entered in the tools as numbers without colon.

The memory prefixes D: I: X: C: B0: .. B31: cannot be used at Ax51 assembler level. The memory prefix is only listed for better understanding. The Lx51 linker/locater and several Debugging tools, for example the µVision2 Debugger, are using memory prefixes to identify the memory class of the address.

80C51MX Memory Layout

The Philips 80C51MX memory layout, shown in the following figure, provides a universal memory map that includes all memory types in a single 16MB address region. The memory layout of the Philips 80C51MX is shown below:

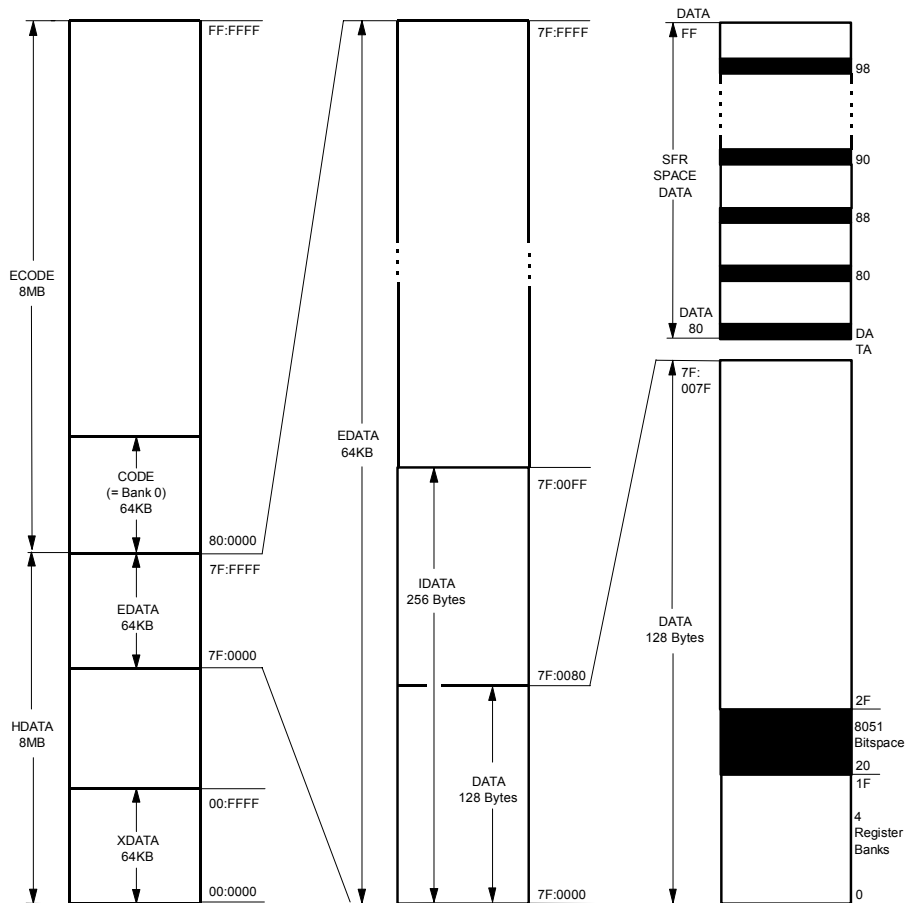

The 80C51MX offers new CPU instructions that provide a new addressing mode, called Universal Pointer addressing. Two Universal Pointer registers PR0 and PR1 are available. PR0 is composed of registers R1, R2, and R3. PR1 is composed of registers R5, R6, and R7. These new Universal Pointer registers hold a 24-bit address that is used together with the EMOV instruction to address the complete 16MB memory.

Intel/Atmel WM 251

Also the 251 architecture is a superset of the classic 8051 architecture. The 251 is the most advanced variant and provides the following key features:

- Completely code compatible with the standard 8051 microcontroller.
- Powerful 8/16/32-bit instructions and flexible 8/16/32-bit registers.
- 16MB linear address space and CPU support for 16-bit and 32-bit pointers.
- True stack-oriented instructions with 16-bit stack pointer.

The following table shows the memory classes used for programming a 251 microcontroller. These memory classes are available when you are using the A251 macro assembler and the L251 linker/locater.

| Memory Class | Address Range | Description |
|---------------|--------------------------------------|--|
| DATA | 00:0000 - 00:007F | Direct addressable on-chip RAM. |
| BIT | 00:0020 - 00:002F | 8051 compatible bit-addressable RAM; can be accessed with short 8-bit addresses. |
| IDATA | 00:0000 - 00:00FF | Indirect addressable on-chip RAM; can be accessed with @R0 or @R1. |
| EDATA | 00:0000 - 00:FFFF | Extended direct addressable memory area; can be accessed with direct 16-bit addresses available on the 251. |
| ECONST | 00:0000 - 00:FFFF | Same as EDATA - but allows the definition of ROM constants. |
| EBIT | 00:0020 - 00:007F | Extended bit-addressable RAM; can be accessed with the extended bit addressing mode available on the 251. |
| XDATA | 01:0000 - 01:FFFF (default space) | 8051 compatible DATA space. Can be mapped on the 251 to any 64 KB memory segment. Accessed with MOVX instruction. |
| HDATA | 00:0000 - FF:FFFF | Full 16 MB address space of the 251. Accessed with MOV @DRK instructions. This space is used for RAM areas. |
| HCONST | 00:0000 - FF:FFFF | Same as HDATA - but allows the definition of ROM constants. |
| ECODE | 00:0000 - FF:FFFF | Full 16 MB address space of the 251; executable code accessed with ECALL or EJMP instructions. |
| CODE | FF:0000 - FF:FFFF (default space) | 8051 compatible CODE space; used for executable code or RAM constants. Can be located with L251 to any 64 KB segment |
| CONST | FF:0000 - FF:FFFF (default space) | Same as CODE - but can be used for ROM constants only. |

Colons are used to improve the readability only.
The addresses are entered in the tools as numbers without colon.

251 Memory Layout

The following figure shows the memory layout of the 251 architecture.

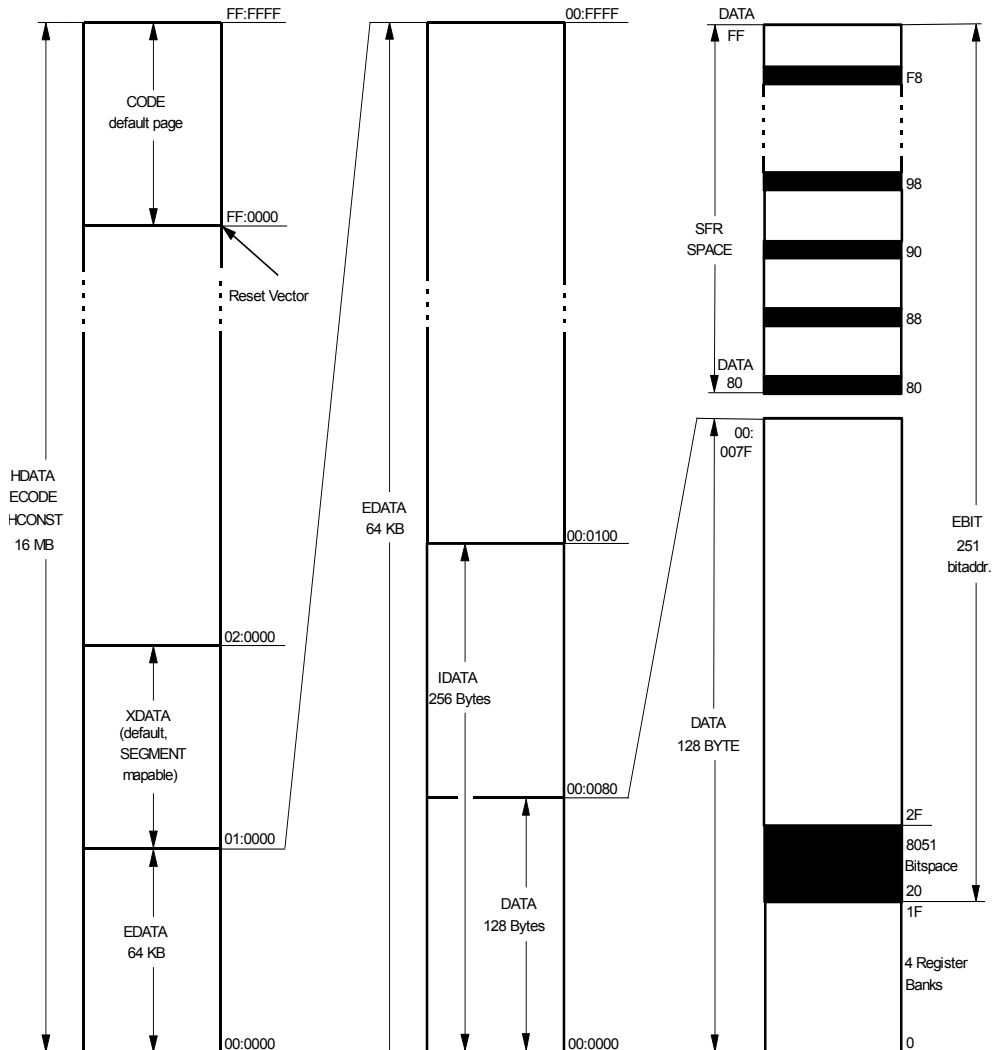

The 251 completely supports all aspects of the classic 8051 memory layout and instruction set. Existing 8051 programs can be directly execute on the 251. The four 8051 memory spaces (DATA, IDATA, CODE and XDATA) are mapped into specific regions of the 16 MB address space.

CPU Registers

The following section provides an overview of the CPU registers that are available on the **x51** variants.

In addition to the CPU registers R0 - R7, all **x51** variants have an SFR space that is used to address on-chip peripherals and I/O ports. In the SFR area also reside the CPU registers SP (stack pointer), PSW (program status word), A (accumulator, accessed via the SFR space as ACC), B, DPL and DPH (16-bit register DPTR).

2

CPU Registers of the 8051 Variants

The classic 8051 provides 4 register banks of 8 registers each. These register banks are mapped into the DATA memory area at address 0 – 0x1F. In addition the CPU provides a 8-bit A (accumulator) and B register and a 16-bit DPTR (data pointer) for addressing XDATA and CODE memory. These registers are also mapped into the SFR space as special function registers.

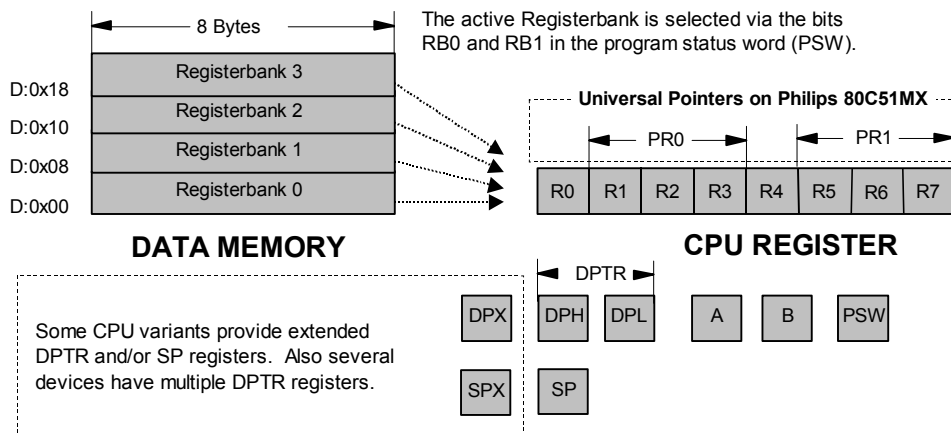

CPU Registers of the Intel/Atmel WM 251

The 251 architecture supports an extra 32 bytes of registers in addition to the 4 banks of 8 registers found in the classic 8051. The lower 8 byte registers are mapped between locations 00:00 - 00:0x1F. The lower 8 byte registers are mapped in this way to support 8051 microcontroller register banking. The register file can be addressed in the following ways:

- Register 0 - 15 can be used as either byte, word, or double word (Dword) registers.
- Register 16 - 31 can be addressed as either word or Dword registers.
- Register DR56 and DR60 can be addressed only as Dword registers.
- There are 16 possible byte registers (R0 - R15), 16 possible word registers (WR0 - WR30) and 10 possible Dword registers (DR0 - DR28, DR56 - DR60) that can be addressed in any combination.
- All Dword registers are Dword aligned; each is addressed as DRk with “k” being the lowest of the 4 consecutive registers. For example, DR4 consists of registers 4 - 7.
- All word registers are word aligned; each is addressed as WRj with “j” being the lower of the 2 consecutive registers. For example WR4 consists of registers 4 - 5.
- All byte registers are inherently byte aligned; each is addressed as Rm with “m” being the register number. For example R4 consists of register 4.

The following figure shows the register file format for the 251 microcontroller.

2

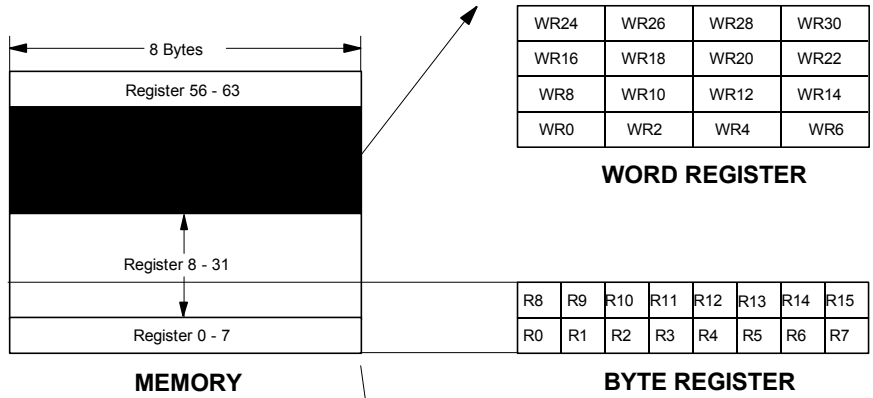

The 8051 CPU Registers A, B, DPL, DPH and SP are mapped into the 251 register file. The following 251 CPU registers are identical with the 8051 CPU registers:

| 8051 Register | 251 Register |
|---------------|------------------|
| A (ACC) | R11 |
| B | R10 |
| DPL | low byte of DR56 |
| DPH | 2nd byte of DR56 |
| SP | low byte of DR60 |

The stack pointer register (DR60) of the 251 CPU is a 16-bit register. DR60 is used for all stack operations (PUSH, POP, CALL, RET, ect.) and can be also used for indirect addressing. Therefore the 251 provides efficient stack addressing modes for reentrant functions.

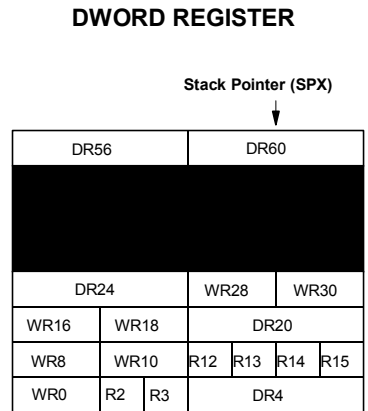
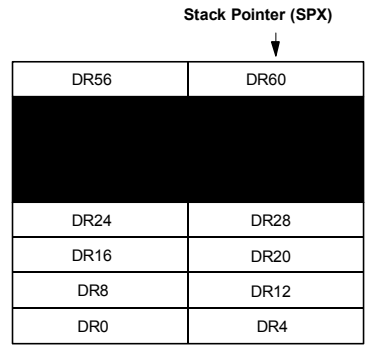

EXAMPLE OF MIXED USAGE

Program Status Word (PSW)

The Program Status Word (PSW) contains status bits that reflect the current CPU state. The 8051 variants provide one special function register called PSW with this status information. The 251 provides two additional status flags, Z and N, that are available in a second special function register called PSW1.

PSW Register (all 8051 and 251 variants)

| Bit 7 | Bit 6 | Bit 5 | Bit 4 | Bit 3 | Bit 2 | Bit 1 | Bit 0 |
|-------|-------|-------|-------|-------|-------|-------|-------|
| CY | AC | F0 | RS1 | RS0 | OV | UD | P |

Additional PSW1 Register (on Intel/Atmel WM 251 only)

| Bit 7 | Bit 6 | Bit 5 | Bit 4 | Bit 3 | Bit 2 | Bit 1 | Bit 0 |
|-------|-------|-------|-------|-------|-------|-------|-------|
| CY | AC | N | RS1 | RS0 | OV | Z | – |

The following table describes the status bits in the PSW.

| Symbol | Function |
|---------------------------|---|
| CY | Carry flag |
| AC | Auxiliary Carry flag (For BCD Operations) |
| F0 | Flag 0 (Available to the user for General Purpose) |
| RS1, RS0 | Register bank select: RS1 RS0 Working Register Bank and Address |
| | 0 0 Bank0 (D:0x00 - D:0x07) |
| | 0 1 Bank1 (D:0x08 - D:0x0F) |
| | 1 0 Bank2 (D:0x10 - D:0x17) |
| | 1 1 Bank3 (D:0x18H - D:0x1F) |
| OV | Overflow flag |
| UD | User definable flag |
| P | Parity flag |
| – | Reserved for future use |
| Z | Zero flag |
| N | Negative flag |

251
ONLY

2

Instruction Sets

This section lists the instructions of all **x51** CPU variants in alphabetical order. The following terms are used in the descriptions.

2

| Identifier | Explanation | |
|--------------------|---|---|
| A | Accumulator | |
| AB | Register Pair A & B | |
| B | Multiplication Register | |
| C | Carry Flag | |
| DPTR | Data pointer | |
| PC | Program Counter | |
| Rn | Register R0 - R7 of the currently selected Register Bank. | |
| dir8 | 8-bit data address; Data RAM (D:0x00 - D:0x7F) or SFR (D:0x80 - D:0xFF) | |
| #data8 | 8-bit constant included in instruction. | |
| #data16 | 16-bit constant included in instruction. | |
| addr16 | 16-bit destination address. | |
| addr11 | 11-bit destination address. Used by ACALL & AJMP. The branch will be within the same 2KByte block of program memory of the first byte of the following instruction. | |
| rel | Signed (two's complement) 8-bit offset. Used by SJMP and conditional jumps. Range is -128 .. +127 bytes relative to the first byte of the following instruction. | |
| bit8 | Direct addressed bit in Data RAM Location. | |
| 251 ONLY | Rm | Register R0 - R15 of the currently selected Register File. |
| | WRj | Register WR0 - WR30 of the currently selected Register File. |
| | DRk | Register DR0 - DR28, DR56, DR60 of the currently selected Register File. |
| | dir16 | 16-bit data address; Data RAM location (00:00 - 00:FFFF). |
| | @WRj | Data RAM location (0 - 64K) addressed indirectly via WR0 - WR30. |
| | @DRk | Data RAM location (0 - 16M) addressed indirectly via DR0 - DR28, DR56, DR60. |
| | #short | constant 1, 2 or 4 included in instruction. |
| | bit11 | Direct addressed bit in Data RAM or Special Function Register. |
| | @Wrj+dis | Data RAM location (0 - 64K) addressed indirectly via WR0 - WR30 + displacement. |
| | @DRk+dis | Data RAM location (0 - 16M) addressed indirectly via DR0 - DR28, DR56, DR60+ 16-bit signed displacement. |
| | 51MX ONLY | EPTR |
| PR0, PR1 | | Universal Pointer Register (PR0 represents R1,R2,R3; PR1 represents R5,R6,R7) |
| @PR0+d2 @PR1+d2 | | Universal memory location (0 - 16M) addressed indirectly via PR0 or PR1+ 2-bit displacement (+0, +1, +2, +3). |
| #data2 | | 2-bit constant included in instruction (value range: #1, #2, #3, #4). |
| addr23 | | 23-bit destination address for HDATA or ECODE |

| ACALL | | Absolute Subroutine CALL | CY — | AC — | N — | OV — | Z — |
|---|--------|---------------------------------|---------------------|----------------|---------------------|----------------|---------------|
| Mnemonic | | Description | Bytes Binary | | Bytes Source | | |
| ACALL | addr11 | Absolute Subroutine Call | 2 | | 2 | | |
| DALLAS 24-Bit Contiguous Address Mode ONLY | | | | | | | |
| ACALL | addr19 | Absolute Subroutine Call | 3 | | | | |

| ADD | | ADD destination, source Addition | CY X | AC X | N X | OV X | Z X | |
|-----------------|-------------|---|---------------------|----------------|---------------------|----------------|---------------|--|
| Mnemonic | | Description | Bytes Binary | | Bytes Source | | | |
| ADD | A,Rn | Add register to accumulator | 1 | | 2 | | | |
| ADD | A,dir8 | Add direct byte to accumulator | 2 | | 2 | | | |
| ADD | A,@Ri | Add indirect RAM to accumulator | 1 | | 2 | | | |
| ADD | A,#data8 | Add immediate data to accumulator | 2 | | 2 | | | |
| 251 ONLY | ADD | Rm,Rm | 3 | | 2 | | | |
| | ADD | WRj,WRj | 3 | | 2 | | | |
| | ADD | DRk,DRk | 3 | | 2 | | | |
| | ADD | Rm,#data8 | 4 | | 3 | | | |
| | ADD | Wrj,#data16 | 5 | | 4 | | | |
| | ADD | Drk,#data16 | 5 | | 4 | | | |
| | ADD | Rm,dir8 | 4 | | 3 | | | |
| | ADD | WRj,dir8 | 4 | | 3 | | | |
| | ADD | Rm,dir16 | 5 | | 4 | | | |
| | ADD | WRj,dir16 | 5 | | 4 | | | |
| | ADD | Rm,@WRj | 4 | | 3 | | | |
| | ADD | Rm,@DRk | 4 | | 3 | | | |
| | MX51 | ADD | PR0,#data2 | 2 | | | | |
| | | ADD | PR1,#data2 | 2 | | | | |

| ADDC | | ADDC destination, source Addition with Carry | CY X | AC X | N X | OV X | Z X |
|-----------------|----------|---|---------------------|----------------|---------------------|----------------|---------------|
| Mnemonic | | Description | Bytes Binary | | Bytes Source | | |
| ADDC | A,Rn | Add register to accumulator with carry flag | 1 | | 2 | | |
| ADDC | A,dir8 | Add direct byte to accumulator with carry flag | 2 | | 2 | | |
| ADDC | A,@Ri | Add indirect RAM to accumulator with carry flag | 1 | | 2 | | |
| ADDC | A,#data8 | Add immediate data to accumulator with carry flag | 2 | | 2 | | |

| AJMP | | Absolute JUMP | CY — | AC — | N — | OV — | Z — |
|---|--------|----------------------|---------------------|----------------|---------------------|----------------|---------------|
| Mnemonic | | Description | Bytes Binary | | Bytes Source | | |
| AJMP | addr11 | Absolute Jump | 2 | | 2 | | |
| DALLAS 24-Bit Contiguous Address Mode ONLY | | | | | | | |
| AJMP | addr19 | Absolute Jump | 3 | | | | |

| ANL | | AND destination, source Logical AND | CY — | AC — | N X | OV — | Z X |
|-----------------|------------|--|---------------------|----------------|---------------------|----------------|---------------|
| Mnemonic | | Description | Bytes Binary | | Bytes Source | | |
| ANL | A,Rn | AND register to accumulator | 1 | | 2 | | |
| ANL | A,dir8 | AND direct byte to accumulator | 2 | | 2 | | |
| ANL | A,@Ri | AND indirect RAM to accumulator | 1 | | 2 | | |
| ANL | A,#data8 | AND immediate data to accumulator | 2 | | 2 | | |
| ANL | dir,A | AND accumulator to direct byte | 2 | | 2 | | |
| ANL | dir,#data8 | AND immediate data to direct byte | 3 | | 3 | | |

| ANL | | AND destination, source Logical AND | CY — | AC — | N X | OV — | Z X |
|-----------------|-----|--|-------------------------|----------------|-------------------------|----------------|---------------|
| Mnemonic | | Description | Bytes Binary | | Bytes Source | | |
| 251 ONLY | ANL | Rm,Rm | 3 | | 2 | | |
| | ANL | WRj,WRj | 3 | | 2 | | |
| | ANL | Rm,#data8 | 4 | | 3 | | |
| | ANL | Wrj,#data16 | 5 | | 4 | | |
| | ANL | Rm,dir8 | 4 | | 3 | | |
| | ANL | Wrj,dir8 | 4 | | 3 | | |
| | ANL | Rm,dir16 | 5 | | 4 | | |
| | ANL | Wrj,dir16 | 5 | | 4 | | |
| | ANL | Rm,@WRj | 4 | | 3 | | |
| | ANL | Rm,@DRk | 4 | | 3 | | |

2

| ANL | | ANL destination, source Logical AND for bit variables | CY X | AC — | N — | OV — | Z — |
|--------------------------------|---------|--|-------------------------|----------------|-------------------------|----------------|---------------|
| Mnemonic | | Description | Bytes Binary | | Bytes Source | | |
| ANL | C,bit8 | AND direct bit to carry; from BIT space | 2 | | 2 | | |
| Intel/Atmel WM 251 ONLY | | | | | | | |
| ANL | C,bit11 | AND direct bit to carry; from EBIT space | 4 | | 3 | | |

| ANL/ | | ANL/ destination, source Logical AND for bit variables | CY X | AC — | N X | OV — | Z X |
|--------------------------------|----------|---|-------------------------|----------------|-------------------------|----------------|---------------|
| Mnemonic | | Description | Bytes Binary | | Bytes Source | | |
| ANL | C,/bit8 | AND complement of dir bit to carry; BIT space | 2 | | 2 | | |
| Intel/Atmel WM 251 ONLY | | | | | | | |
| ANL | C,/bit11 | AND complement of dir bit to carry; EBIT space | 4 | | 3 | | |

| CJNE | | COMPARE destination, source and jump if not equal | CY X | AC — | N X | OV — | Z X |
|-----------------|----------------|--|---------------------|----------------|---------------------|----------------|---------------|
| Mnemonic | | Description | Bytes Binary | | Bytes Source | | |
| CJNE | A,dir8,rel | Compare dir byte to acc. and jump if not equal | 3 | | 3 | | |
| CJNE | /A,#data8,rel | Compare imm. data to acc. and jump if not equal | 3 | | 3 | | |
| CJNE | Rn,#data8,rel | Compare imm. data to reg and jump if not equal | 3 | | 4 | | |
| CJNE | @Ri,#data8,rel | Compare imm. data to indir and jump if not equal | 3 | | 4 | | |

| CLR | | CLEAR Operand | CY — | AC — | N X | OV — | Z X |
|-----------------|---|----------------------|---------------------|----------------|---------------------|----------------|---------------|
| Mnemonic | | Description | Bytes Binary | | Bytes Source | | |
| CLR | A | Clear accumulator | 1 | | 1 | | |

| CLR | | CLEAR Bit Operand | CY — | AC — | N — | OV — | Z — |
|--------------------------------|-------|----------------------------------|---------------------|----------------|---------------------|----------------|---------------|
| Mnemonic | | Description | Bytes Binary | | Bytes Source | | |
| CLR | C | Clear carry | 1 | | 1 | | |
| CLR | bit8 | Clear direct bit from BIT space | 2 | | 2 | | |
| Intel/Atmel WM 251 ONLY | | | | | | | |
| CLR | bit11 | Clear direct bit from EBIT space | 4 | | 3 | | |

| CMP | | COMPARE Operands | | CY | AC | N | OV | Z |
|-----------------|-------------|--|--|---------------------|-----------|---------------------|-----------|----------|
| | | | | X | X | X | X | X |
| Mnemonic | | Description | | Bytes Binary | | Bytes Source | | |
| CMP | Rm,Rm | Compare registers | | 3 | | 2 | | |
| CMP | WRj,WRj | Compare word registers | | 3 | | 2 | | |
| CMP | DRk,DRk | Compare double word registers | | 3 | | 2 | | |
| CMP | Rm,#data8 | Compare register with immediate data | | 4 | | 3 | | |
| CMP | Wrj,#data16 | Compare word register with immediate data | | 5 | | 4 | | |
| CMP | Drk,#00 | Compare dword reg with zero extended data | | 5 | | 4 | | |
| CMP | Drk,#ff | Compare dword reg with one extended data | | 5 | | 4 | | |
| CMP | Rm,dir8 | Compare register with direct byte | | 4 | | 3 | | |
| CMP | WRj,dir8 | Compare word register with direct word | | 4 | | 3 | | |
| CMP | Rm,dir16 | Compar register with direct byte (64K) | | 5 | | 4 | | |
| CMP | WRj,dir16 | Compare word register with direct word (64K) | | 5 | | 4 | | |
| CMP | Rm,@WRj | Compare register with indirect address (64K) | | 4 | | 3 | | |
| CMP | Rm,@DRk | Compare register with indirect address (16M) | | 4 | | 3 | | |

251 ONLY

2

| CPL | | COMPLEMENT Operand | | CY | AC | N | OV | Z |
|-----------------|---|---------------------------|--|---------------------|-----------|---------------------|-----------|----------|
| | | | | — | — | X | — | X |
| Mnemonic | | Description | | Bytes Binary | | Bytes Source | | |
| CPL | A | Complement accumulator | | 1 | | 1 | | |

| CPL | | COMPLEMENT Bit Operand | | CY | AC | N | OV | Z |
|--------------------------------|-------|---------------------------------------|--|---------------------|-----------|---------------------|-----------|----------|
| | | | | — | — | — | — | — |
| Mnemonic | | Description | | Bytes Binary | | Bytes Source | | |
| CPL | C | Complement carry | | 1 | | 1 | | |
| CPL | bit8 | Complement direct bit from BIT space | | 2 | | 2 | | |
| Intel/Atmel WM 251 ONLY | | | | | | | | |
| CPL | bit11 | Complement direct bit from EBIT space | | 4 | | 3 | | |

| DA | | DECIMAL ADJUST Accumulator for Addition | CY X | AC — | N X | OV — | Z X |
|-----------------|---|--|---------------------|----------------|---------------------|----------------|---------------|
| Mnemonic | | Description | Bytes Binary | | Bytes Source | | |
| DA | A | Decimal adjust accumulator | 1 | | 1 | | |

| DEC | | DECREMENT Operand with a constant | CY — | AC — | N X | OV — | Z X |
|--------------------------------|------------|---|---------------------|----------------|---------------------|----------------|---------------|
| Mnemonic | | Description | Bytes Binary | | Bytes Source | | |
| DEC | A | Decrement accumulator | 1 | | 1 | | |
| DEC | Rn | Decrement register | 1 | | 2 | | |
| DEC | dir | Decrement dir byte | 2 | | 2 | | |
| DEC | @Ri | Decrement indir RAM | 1 | | 2 | | |
| Intel/Atmel WM 251 ONLY | | | | | | | |
| DEC | Rm,#short | Decrement byte register with 1, 2 or 4 | 3 | | 2 | | |
| DEC | WRj,#short | Decrement word register with 1, 2 or 4 | 3 | | 2 | | |
| DEC | DRk,#short | Decrement double word register with 1, 2 or 4 | 3 | | 2 | | |

| DIV | | DIVIDE Operands | CY 0 | AC — | N X | OV X | Z X |
|--------------------------------|---------|---------------------------------------|---------------------|----------------|---------------------|----------------|---------------|
| Mnemonic | | Description | Bytes Binary | | Bytes Source | | |
| DIV | AB | Divide A by B | 1 | | 1 | | |
| Intel/Atmel WM 251 ONLY | | | | | | | |
| DIV | Rm,Rm | Divide byte register by byte register | 3 | | 2 | | |
| DIV | WRj,WRj | Divide word register by word register | 3 | | 2 | | |

| DJNZ | | DECREMENT Operand and Jump if Not Zero | CY — | AC — | N X | OV — | Z X |
|-----------------|----------|---|---------------------|----------------|---------------------|----------------|---------------|
| Mnemonic | | Description | Bytes Binary | | Bytes Source | | |
| DJNZ | Rn,rel | Decrement register and jump if not zero | 2 | | 3 | | |
| DJNZ | dir8,rel | Decrement direct byte and jump if not zero | 3 | | 3 | | |

| ECALL | | Extended Subroutine CALL | CY | AC | N | OV | Z |
|--------------------------------|--------|--------------------------|--------------|----|--------------|----|---|
| | | | — | — | — | — | — |
| Mnemonic | | Description | Bytes Binary | | Bytes Source | | |
| Intel/Atmel WM 251 ONLY | | | | | | | |
| ECALL | addr24 | Extended subroutine call | 5 | | 4 | | |
| ECALL | DRk | Extended subroutine call | 3 | | 2 | | |
| Philips 80C51MX ONLY | | | | | | | |
| ECALL | addr23 | Extended subroutine Call | 5 | | | | |

2

| EJMP | | Extended JUMP | CY | AC | N | OV | Z |
|--------------------------------|--------|---------------|--------------|----|--------------|----|---|
| | | | — | — | — | — | — |
| Mnemonic | | Description | Bytes Binary | | Bytes Source | | |
| Intel/Atmel WM 251 ONLY | | | | | | | |
| EJMP | addr24 | Extended jump | 5 | | 4 | | |
| EJMP | DRk | Extended jump | 3 | | 2 | | |
| Philips 80C51MX ONLY | | | | | | | |
| EJMP | addr23 | Extended jump | 5 | | | | |

| 51MX ONLY | EMOV | | MOV destination, source Move data via Universal Pointer | CY | AC | N | OV | Z |
|-----------|-------------|--|--|----|--------------|---|----|---|
| | | | | | — | — | — | — |
| Mnemonic | | Description | Bytes Binary | | Bytes Source | | | |
| EMOV | A,@PR0+d2 | Move indirect (16M) via Universal Pointer to A | 2 | | | | | |
| EMOV | A,@PR1+d2 | Move indirect (16M) via Universal Pointer to A | 2 | | | | | |
| EMOV | @PR0+d2,A | Move A to indirect (16M) via Universal Pointer | 2 | | | | | |
| EMOV | @PR1+d2,A | Move A to indirect (16M) via Universal Pointer | 2 | | | | | |

2

| ERET | | RETURN from extended Subroutine | CY | AC | N | OV | Z |
|-------------|--|---------------------------------|--------------|----|--------------|----|---|
| | | | — | — | — | — | — |
| Mnemonic | | Description | Bytes Binary | | Bytes Source | | |
| ERET | | Return from subroutine | 2 | | 1 | | |

| INC | | INCREMENT Operand with a constant | CY | AC | N | OV | Z |
|-----------------------------|------|-----------------------------------|--------------|----|--------------|----|---|
| | | | — | — | X | — | X |
| Mnemonic | | Description | Bytes Binary | | Bytes Source | | |
| INC | A | Increment accumulator | 1 | | 1 | | |
| INC | Rn | Increment register | 1 | | 2 | | |
| INC | dir | Increment direct byte | 2 | | 2 | | |
| INC | @Ri | Increment indirect RAM | 1 | | 2 | | |
| INC | DPTR | Increment Data Pointer | 1 | | 1 | | |
| 251 ONLY | INC | Rm,#short | 3 | | 2 | | |
| | INC | WRj,#short | 3 | | 2 | | |
| | INC | Drk,#short | 3 | | 2 | | |
| Philips 80C51MX ONLY | | | | | | | |
| INC | EPTR | Increment Enhanced Data Pointer | 2 | | | | |

| JB | | JUMP if Bit is set | CY | AC | N | OV | Z |
|--------------------------------|-----------|--|--------------|----|--------------|----|---|
| | | | — | — | — | — | — |
| Mnemonic | | Description | Bytes Binary | | Bytes Source | | |
| JB | bit8,rel | Jump if dir bit (from BIT space) is set | 3 | | 3 | | |
| Intel/Atmel WM 251 ONLY | | | | | | | |
| JB | bit11,rel | Jump if dir bit (from EBIT space) is set | 5 | | 4 | | |

| JBC | | JUMP if Bit is set and clear bit | CY — | AC — | N — | OV — | Z — |
|--------------------------------|-----------|---|---------------------|---------------------|---------------|----------------|---------------|
| Mnemonic | | Description | Bytes Binary | Bytes Source | | | |
| JBC | bit8,rel | Jump if dir bit (BIT space) is set and clear bit | 3 | 3 | | | |
| Intel/Atmel WM 251 ONLY | | | | | | | |
| JBC | bit11,rel | Jump if dir bit (EBIT space) is set and clear bit | 5 | 4 | | | |

| JC / JL | | JUMP if Carry is set JUMP if less than | CY — | AC — | N — | OV — | Z — |
|--------------------------------|-----|---|---------------------|---------------------|---------------|----------------|---------------|
| Mnemonic | | Description | Bytes Binary | Bytes Source | | | |
| JC | rel | Jump if carry is set | 2 | 2 | | | |
| Intel/Atmel WM 251 ONLY | | | | | | | |
| JL | rel | Jump if less than | 2 | 2 | | | |

| 251 ONLY | JE | | JUMP if equal | CY — | AC — | N — | OV — | Z — |
|-----------------|-----------------|-----|----------------------|---------------------|---------------------|---------------|----------------|---------------|
| | Mnemonic | | Description | Bytes Binary | Bytes Source | | | |
| | JE | rel | Jump if equal | 3 | 2 | | | |

| 251 ONLY | JG | | JUMP if greater than | CY — | AC — | N — | OV — | Z — |
|-----------------|-----------------|-----|-----------------------------|---------------------|---------------------|---------------|----------------|---------------|
| | Mnemonic | | Description | Bytes Binary | Bytes Source | | | |
| | JG | rel | Jump if greater than | 3 | 2 | | | |

2

| | | | | | | | | |
|-----------------|-----------------|-----|-----------------------------------|---------------------|----------------|---------------------|----------------|---------------|
| 251 ONLY | JLE | | JUMP if less than or equal | CY — | AC — | N — | OV — | Z — |
| | Mnemonic | | Description | Bytes Binary | | Bytes Source | | |
| | JLE | rel | Jump if less than or equal | 3 | | 2 | | |

| | | | | | | | |
|-----------------------------|---------|------------------------------------|---------------------|----------------|---------------------|----------------|---------------|
| JMP | | JUMP indir relative to DPTR | CY — | AC — | N — | OV — | Z — |
| Mnemonic | | Description | Bytes Binary | | Bytes Source | | |
| JMP | @A+DPTR | Jump indir relative to DPTR | 1 | | 1 | | |
| Philips 80C51MX ONLY | | | | | | | |
| JMP | @A+EPTR | JUMP indirect relative to EPTR | 2 | | | | |

| | | | | | | | |
|--------------------------------|-----------|--|---------------------|----------------|---------------------|----------------|---------------|
| JNB | | JUMP if Bit is Not set | CY — | AC — | N — | OV — | Z — |
| Mnemonic | | Description | Bytes Binary | | Bytes Source | | |
| JNB | bit8,rel | Jump if dir bit (from BIT space) is not set | 3 | | 3 | | |
| Intel/Atmel WM 251 ONLY | | | | | | | |
| JNB | bit11,rel | Jump if dir bit (from EBIT space) is not set | 5 | | 4 | | |

| | | | | | | | |
|--------------------------------|-----|---|---------------------|----------------|---------------------|----------------|---------------|
| JNC / JGE | | JUMP if Carry is Not set JUMP if greater than or equal | CY — | AC — | N — | OV — | Z — |
| Mnemonic | | Description | Bytes Binary | | Bytes Source | | |
| JNC | rel | Jump if carry is not set | 2 | | 2 | | |
| Intel/Atmel WM 251 ONLY | | | | | | | |
| JGE | rel | Jump if greater than or equal | 2 | | 2 | | |

| | | | | | | | | | |
|-----------------|-----------------|-----|--------------------------|--|-----------|---------------------|----------|---------------------|----------|
| 251 ONLY | JNE | | JUMP if Not Equal | | CY | AC | N | OV | Z |
| | | | | | — | — | — | — | — |
| | Mnemonic | | Description | | | Bytes Binary | | Bytes Source | |
| | JNE | rel | Jump if not equal | | | 3 | | 2 | |

| | | | | | | | | | |
|-----------------|-----|--|---------------------------------|--|---------------------|-----------|---------------------|-----------|----------|
| JNZ | | JUMP if Accumulator is Not Zero | | | CY | AC | N | OV | Z |
| | | | | | — | — | — | — | — |
| Mnemonic | | Description | | | Bytes Binary | | Bytes Source | | |
| | JNZ | rel | Jump if accumulator is not zero | | | 2 | | 2 | |

| | | | | | | | | | |
|-----------------|-----------------|-----|--------------------------------------|--|-----------|---------------------|----------|---------------------|----------|
| 251 ONLY | JSG | | JUMP if greater than (Signed) | | CY | AC | N | OV | Z |
| | | | | | — | — | — | — | — |
| | Mnemonic | | Description | | | Bytes Binary | | Bytes Source | |
| | JSG | rel | Jump if greater than (signed) | | | 3 | | 2 | |

| | | | | | | | | | |
|-----------------|-----------------|-----|---|--|-----------|---------------------|----------|---------------------|----------|
| 251 ONLY | JSGE | | JUMP if greater than or Equal (Signed) | | CY | AC | N | OV | Z |
| | | | | | — | — | — | — | — |
| | Mnemonic | | Description | | | Bytes Binary | | Bytes Source | |
| | JSGE | rel | Jump if greater than or equal (signed) | | | 3 | | 2 | |

| | | | | | | | | | |
|-----------------|-----------------|-----|-----------------------------------|--|-----------|---------------------|----------|---------------------|----------|
| 251 ONLY | JSL | | JUMP if Less than (Signed) | | CY | AC | N | OV | Z |
| | | | | | — | — | — | — | — |
| | Mnemonic | | Description | | | Bytes Binary | | Bytes Source | |
| | JSL | rel | Jump if less than (signed) | | | 3 | | 2 | |

| | | | | | | | | | |
|-----------------|-----------------|-----|--|--|-----------|---------------------|----------|---------------------|----------|
| 251 ONLY | JSLE | | JUMP if Less than or Equal (Signed) | | CY | AC | N | OV | Z |
| | | | | | — | — | — | — | — |
| | Mnemonic | | Description | | | Bytes Binary | | Bytes Source | |
| | JSLE | rel | Jump if less than or equal (signed) | | | 3 | | 2 | |

| | | | | | | | | | |
|-----------------|-----|------------------------------------|--|--|---------------------|-----------|---------------------|-----------|----------|
| JZ | | JUMP if Accumulator is Zero | | | CY | AC | N | OV | Z |
| | | | | | — | — | — | — | — |
| Mnemonic | | Description | | | Bytes Binary | | Bytes Source | | |
| JZ | rel | Jump if accumulator is zero | | | 2 | | 2 | | |

| | | | | | | | | | |
|---|--------|--------------------------------------|--|--|---------------------|-----------|---------------------|-----------|----------|
| LCALL | | Long Subroutine CALL | | | CY | AC | N | OV | Z |
| | | | | | — | — | — | — | — |
| Mnemonic | | Description | | | Bytes Binary | | Bytes Source | | |
| LCALL | addr16 | Long Subroutine Call | | | 3 | | 3 | | |
| Intel/Atmel WM 251 ONLY | | | | | | | | | |
| LJMP | @WRj | Long Jump indirect via word register | | | 3 | | 2 | | |
| DALLAS 24-Bit Contiguous Address Mode ONLY | | | | | | | | | |
| LCALL | addr24 | Absolute Subroutine Call | | | 4 | | | | |

| | | | | | | | | | |
|---|--------|--------------------------------------|--|--|---------------------|-----------|---------------------|-----------|----------|
| LJMP | | Long JUMP | | | CY | AC | N | OV | Z |
| | | | | | — | — | — | — | — |
| Mnemonic | | Description | | | Bytes Binary | | Bytes Source | | |
| LJMP | addr16 | Long Jump | | | 3 | | 3 | | |
| Intel/Atmel WM 251 ONLY | | | | | | | | | |
| LJMP | @WRj | Long Jump indirect via word register | | | 3 | | 2 | | |
| DALLAS 24-Bit Contiguous Address Mode ONLY | | | | | | | | | |
| LJMP | addr24 | Absolute Subroutine Call | | | 4 | | | | |

| MOV | | MOV destination, source Move data | CY — | AC — | N — | OV — | Z — | |
|-----------------|--------------|---|--|---------------------|---------------|----------------|---------------|--|
| Mnemonic | | Description | Bytes Binary | Bytes Source | | | | |
| MOV | A,Rn | Move register to accumulator | 1 | 2 | | | | |
| MOV | A,dir8 | Move direct byte to accumulator | 2 | 2 | | | | |
| MOV | A,@Ri | Move indirect RAM to accumulator | 1 | 2 | | | | |
| MOV | A,#data8 | Move immediate data to accumulator | 2 | 2 | | | | |
| MOV | Rn,A | Move accumulator to register | 1 | 2 | | | | |
| MOV | Rn,dir8 | Move direct byte to register | 2 | 3 | | | | |
| MOV | Rn,#data8 | Move immediate data to register | 2 | 3 | | | | |
| MOV | dir8,A | Move accumulator to direct byte | 2 | 2 | | | | |
| MOV | dir8,Rn | Move register to direct byte | 2 | 3 | | | | |
| MOV | dir8,dir8 | Move direct byte to direct byte | 3 | 3 | | | | |
| MOV | dir8,@Ri | Move indirect RAM to direct byte | 2 | 3 | | | | |
| MOV | dir8,#data8 | Move immediate data to direct byte | 3 | 3 | | | | |
| MOV | @Ri,A | Move accumulator to indirect RAM | 1 | 2 | | | | |
| MOV | @Ri,dir8 | Move direct byte to indirect RAM | 2 | 3 | | | | |
| MOV | @Ri,#data8 | Move immediate data to indirect RAM | 2 | 3 | | | | |
| MOV | DPTR,#data16 | Load Data Pointer with 16-bit constant | 3 | 3 | | | | |
| MOV | C,bit8 | Move dir bit to carry | 2 | 2 | | | | |
| MOV | bit8,C | Move carry to dir bit | 2 | 2 | | | | |
| 251 ONLY | MOV | Rm,Rm | Move byte register to byte register | 3 | 2 | | | |
| | MOV | WRj,WRj | Move word register to word register | 3 | 2 | | | |
| | MOV | DRk,DRk | Move dword register to dword register | 3 | 2 | | | |
| | MOV | Rm,#data8 | Move 8 bit data to byte register | 4 | 3 | | | |
| | MOV | WRj,#data16 | Move 16 bit data to word register | 5 | 4 | | | |
| | MOV | DRk,#0data16 | Move 16 bit zero extended data to dword reg. | 5 | 4 | | | |
| | MOV | DRk,#1data16 | Move 16 bit one extended data to dword reg. | 5 | 4 | | | |
| | MOV | Rm,dir8 | Move dir address to byte register | 4 | 3 | | | |
| | MOV | WRj,dir8 | Move direct address to word register | 4 | 3 | | | |
| | MOV | DRk,dir8 | Move direct address to dword register | 4 | 3 | | | |
| | MOV | Rm,dir16 | Move direct address (64K) to byte register | 5 | 4 | | | |
| | MOV | WRj,dir16 | Move direct address (64K) to word register | 5 | 4 | | | |
| | MOV | DRk,dir16 | Move direct address (64K) to dword register | 5 | 4 | | | |
| | MOV | Rm,@WRj | Move indirect address (64K) to byte register | 4 | 3 | | | |
| | MOV | Rm,@DRk | Move indirect address (16M) to byte register | 4 | 3 | | | |
| | MOV | WRj,@WRj | Move indirect address (64K) to word register | 4 | 3 | | | |
| | MOV | WRj,@DRk | Move indirect address (16M) to word register | 4 | 3 | | | |

| MOV | | MOV destination, source Move data | CY — | AC — | N — | OV — | Z — |
|-----------------------------|--------------|--|---------------------|---------------------|---------------|----------------|---------------|
| Mnemonic | | Description | Bytes Binary | Bytes Source | | | |
| MOV | dir8,Rm | Move byte register to direct address | 4 | 3 | | | |
| MOV | dir8,WRj | Move word register to direct address | 4 | 3 | | | |
| MOV | dir8,DRk | Move dword register to direct address | 4 | 3 | | | |
| MOV | dir16,Rm | Move byte register to direct address (64K) | 5 | 4 | | | |
| MOV | dir16,WRj | Move word register to direct address (64K) | 5 | 4 | | | |
| MOV | dir16,DRk | Move dword register to direct address (64K) | 5 | 4 | | | |
| MOV | @WRj,Rm | Move byte register to direct address (64K) | 4 | 3 | | | |
| MOV | @DRk,Rm | Move byte register to indirect address (16M) | 4 | 3 | | | |
| MOV | @WRj,WRj | Move word register to indirect address (64K) | 4 | 3 | | | |
| MOV | @DRk,WRj | Move word register to indirect address (16M) | 4 | 3 | | | |
| MOV | Rm,@WRj+dis | Move displacement address (64K) to byte reg. | 5 | 4 | | | |
| MOV | WRj,@WRj+dis | Move displacement address (64K) to word reg. | 5 | 4 | | | |
| MOV | Rm,@DRk+dis | Move displacement address (16M) to byte reg. | 5 | 4 | | | |
| MOV | WRj,@DRk+dis | Move displacement address (16M) to word reg. | 5 | 4 | | | |
| MOV | @WRj+dis,Rm | Move byte reg. to displacement address (64K) | 5 | 4 | | | |
| MOV | @WRj+dis,WRj | Move word reg. to displacement address (64K) | 5 | 4 | | | |
| MOV | @DRk+dis,Rm | Move byte reg. to displacement address (16M) | 5 | 4 | | | |
| MOV | @DRk+dis,WRj | Move word reg. to displacement address (16M) | 5 | 4 | | | |
| MOV | C,bit11 | Move dir bit from 8 bit address location to carry | 2 | 2 | | | |
| MOV | bit11,C | Move carry to dir bit from 16 bit address location | 5 | 4 | | | |
| Philips 80C51MX ONLY | | | | | | | |
| MOV | EPTR,#adr23 | Load extended data pointer with constant | 5 | | | | |

| MOVC | | MOV destination, source Move Code byte | CY | AC | N | OV | Z |
|-----------------------------|-----------|---|---------------------|-----------|---------------------|-----------|----------|
| | | | — | — | — | — | — |
| Mnemonic | | Description | Bytes Binary | | Bytes Source | | |
| MOVC | A,@A+DPTR | Move code byte relative to DPTR to accumulator | 1 | | 1 | | |
| MOVC | A,@A+PC | Move code byte relative to PC to accumulator | 1 | | 1 | | |
| Philips 80C51MX ONLY | | | | | | | |
| MOVC | A,@A+EPTR | Move code byte relative to EPTR to accumulator | 2 | | | | |

2

| 251 ONLY | MOVH | | MOVH destination, source Move data to high word of DR | CY | AC | N | OV | Z |
|-----------------|-----------------|---|--|---------------------|-----------|---------------------|-----------|----------|
| | | | | — | — | — | — | — |
| | Mnemonic | | Description | Bytes Binary | | Bytes Source | | |
| MOVH | DRk,#data16 | Move 16bit imm. data to high word of dword reg. | 3 | | 2 | | | |

| 251 ONLY | MOVS | | MOVS destination, source Move byte to word (signed ext.) | CY | AC | N | OV | Z |
|-----------------|-----------------|-------------------------------------|---|---------------------|-----------|---------------------|-----------|----------|
| | | | | — | — | — | — | — |
| | Mnemonic | | Description | Bytes Binary | | Bytes Source | | |
| MOVS | WRj,Rm | Move byte register to word register | 3 | | 2 | | | |

| MOVX | | MOV destination, source External RAM access | CY | AC | N | OV | Z |
|-----------------|---------|--|---------------------|-----------|---------------------|-----------|----------|
| | | | — | — | — | — | — |
| Mnemonic | | Description | Bytes Binary | | Bytes Source | | |
| MOVX | A,@Ri | Move xdata RAM (8 bit address) to accumulator | 1 | | 2 | | |
| MOVX | A,@DPTR | Move xdata RAM (16 bit address) to accumulator | 1 | | 1 | | |
| MOVX | @Ri,A | Move accumulator to xdata RAM (8 bit address) | 1 | | 2 | | |
| MOVX | @DPTR,A | Move accumulator to xdata RAM (16 bit address) | 1 | | 1 | | |

| MOVX | | MOV destination, source External RAM access | CY | AC | N | OV | Z |
|-----------------------------|---------|--|---------------------|-----------|---------------------|-----------|----------|
| | | | — | — | — | — | — |
| Mnemonic | | Description | Bytes Binary | | Bytes Source | | |
| Philips 80C51MX ONLY | | | | | | | |
| MOVX | @EPTR,A | Move accu to xdata RAM (23 bit address) | 2 | | | | |
| MOVX | A,@EPTR | Move xdata RAM (23 bit address) to accu | 2 | | | | |

| 251 ONLY | MOVZ | | MOV destination, source Move byte to word (zero ext.) | CY | AC | N | OV | Z |
|-----------------|-------------|---|--|-----------|---------------------|----------|-----------|----------|
| | | | | — | — | — | — | — |
| Mnemonic | | Description | Bytes Binary | | Bytes Source | | | |
| MOVZ | WRj,Rm | Move byte reg. to word reg. (zero extended) | 3 | | 2 | | | |

| MUL | | MULTIPLY Operands | CY | AC | N | OV | Z |
|--------------------------------|---------|---|---------------------|-----------|---------------------|-----------|----------|
| | | | 0 | — | X | X | X |
| Mnemonic | | Description | Bytes Binary | | Bytes Source | | |
| MUL | AB | Multiply A and B | 1 | | 1 | | |
| Intel/Atmel WM 251 ONLY | | | | | | | |
| MUL | Rm,Rm | Multiply byte register with byte register | 3 | | 2 | | |
| MUL | WRj,WRj | Multiply word register with word register | 3 | | 2 | | |

| NOP | | No Operation | CY | AC | N | OV | Z |
|-----------------|--|---------------------|---------------------|-----------|---------------------|-----------|----------|
| | | | — | — | — | — | — |
| Mnemonic | | Description | Bytes Binary | | Bytes Source | | |
| NOP | | No operation | 1 | | 1 | | |

| ORL | | ORL destination, source Logical OR | CY — | AC — | N X | OV — | Z X |
|-----------------|------------|--|---------------------|----------------|---------------------|----------------|---------------|
| Mnemonic | | Description | Bytes Binary | | Bytes Source | | |
| ORL | A,Rn | OR register to accumulator | 1 | | 2 | | |
| ORL | A,dir8 | OR dir byte to accumulator | 2 | | 2 | | |
| ORL | A,@Ri | OR indir RAM to accumulator | 1 | | 2 | | |
| ORL | A,#data8 | OR immediate data to accumulator | 2 | | 2 | | |
| ORL | dir,A | OR accumulator to dir byte | 2 | | 2 | | |
| ORL | dir,#data8 | OR immediate data to dir byte | 3 | | 3 | | |
| 251 ONLY | ORL | Rm,Rm | 3 | | 2 | | |
| | ORL | WRj,WRj | 3 | | 2 | | |
| | ORL | Rm,#data8 | 4 | | 3 | | |
| | ORL | WRj,#data16 | 5 | | 4 | | |
| | ORL | Rm,dir8 | 4 | | 3 | | |
| | ORL | WRj,dir8 | 4 | | 3 | | |
| | ORL | Rm,dir16 | 5 | | 4 | | |
| | ORL | WRj,dir16 | 5 | | 4 | | |
| | ORL | Rm,@WRj | 4 | | 3 | | |
| | ORL | Rm,@DRk | 4 | | 3 | | |

2

| ORL | | ORL destination, source Logical OR for bit variables | CY X | AC — | N — | OV — | Z — |
|--------------------------------|---------|--|---------------------|----------------|---------------------|----------------|---------------|
| Mnemonic | | Description | Bytes Binary | | Bytes Source | | |
| ORL | C,bit8 | OR direct bit to carry; from BIT space | 2 | | 2 | | |
| Intel/Atmel WM 251 ONLY | | | | | | | |
| ORL | C,bit11 | OR direct bit to carry; from EBIT space | 4 | | 3 | | |

| ORL/ | | ORL/ destination, source Logical OR with Complement | CY | AC | N | OV | Z |
|--------------------------------|----------|--|---------------------|-----------|---------------------|-----------|----------|
| | | | X | — | X | — | X |
| Mnemonic | | Description | Bytes Binary | | Bytes Source | | |
| ORL | C,/bit8 | OR complement of direct bit to carry; BIT space | 2 | | 2 | | |
| Intel/Atmel WM 251 ONLY | | | | | | | |
| ORL | C,/bit11 | OR complement of dir bit to carry; EBIT space | 4 | | 3 | | |

| POP | | POP Operand from Stack | CY | AC | N | OV | Z |
|-----------------|------|-------------------------------------|---------------------|-----------|---------------------|-----------|----------|
| | | | — | — | — | — | — |
| Mnemonic | | Description | Bytes Binary | | Bytes Source | | |
| POP | dir8 | Pop direct byte from stack | 2 | | 2 | | |
| POP | Rm | Pop byte register from stack | 3 | | 2 | | |
| POP | WRj | Pop word register from stack | 3 | | 2 | | |
| POP | DRk | Pop double word register from stack | 3 | | 2 | | |

251 ONLY

| PUSH | | PUSH Operand onto Stack | CY | AC | N | OV | Z |
|-----------------|---------|---|---------------------|-----------|---------------------|-----------|----------|
| | | | — | — | — | — | — |
| Mnemonic | | Description | Bytes Binary | | Bytes Source | | |
| PUSH | dir8 | Push direct byte onto stack | 2 | | 2 | | |
| PUSH | Rm | Push byte register onto stack | 3 | | 2 | | |
| PUSH | WRj | Push word register onto stack | 3 | | 2 | | |
| PUSH | DRk | Push double word register onto stack | 3 | | 2 | | |
| PUSH | #data8 | Push immediate data onto stack | 4 | | 3 | | |
| PUSH | #data16 | Push immediate data (16 bit) onto stack | 5 | | 4 | | |

251 ONLY

| RET | | RETURN from Subroutine | CY | AC | N | OV | Z |
|-----------------|--|-------------------------------|---------------------|-----------|---------------------|-----------|----------|
| | | | — | — | — | — | — |
| Mnemonic | | Description | Bytes Binary | | Bytes Source | | |
| RET | | Return from subroutine | 1 | | 1 | | |

| | | | | | | | |
|-----------------|--|-----------------------|---------------------|----|---------------------|----|---|
| RETI | | RETURN from Interrupt | CY | AC | N | OV | Z |
| | | | — | — | — | — | — |
| Mnemonic | | Description | Bytes Binary | | Bytes Source | | |
| RETI | | Return from interrupt | 1 | | 1 | | |

| | | | | | | | |
|-----------------|---|-------------------------|---------------------|----|---------------------|----|---|
| RL | | ROTATE Accumulator Left | CY | AC | N | OV | Z |
| | | | — | — | X | — | X |
| Mnemonic | | Description | Bytes Binary | | Bytes Source | | |
| RL | A | Rotate accumulator left | 1 | | 1 | | |

| | | | | | | | |
|-----------------|---|---|---------------------|----|---------------------|----|---|
| RLC | | ROTATE Accumulator Left through the Carry | CY | AC | N | OV | Z |
| | | | X | — | X | — | X |
| Mnemonic | | Description | Bytes Binary | | Bytes Source | | |
| RLC | A | Rotate accumulator left through the carry | 1 | | 1 | | |

| | | | | | | | |
|-----------------|---|--------------------------|---------------------|----|---------------------|----|---|
| RR | | ROTATE Accumulator Right | CY | AC | N | OV | Z |
| | | | — | — | X | — | X |
| Mnemonic | | Description | Bytes Binary | | Bytes Source | | |
| RR | A | Rotate accumulator right | 1 | | 1 | | |

| | | | | | | | |
|-----------------|---|--|---------------------|----|---------------------|----|---|
| RRC | | ROTATE Accumulator Right through the Carry | CY | AC | N | OV | Z |
| | | | X | — | X | — | X |
| Mnemonic | | Description | Bytes Binary | | Bytes Source | | |
| RRC | A | Rotate accumulator right through the carry | 1 | | 1 | | |

| SETB | | SET Bit Operand | CY | AC | N | OV | Z |
|--------------------------------|-------|--------------------------------|--------------|--------------|---|----|---|
| | | | — | — | — | — | — |
| Mnemonic | | Description | Bytes Binary | Bytes Source | | | |
| SETB | C | Set carry | 1 | 1 | | | |
| SETB | bit8 | Set direct bit from BIT space | 2 | 2 | | | |
| Intel/Atmel WM 251 ONLY | | | | | | | |
| SETB | bit11 | Set direct bit from EBIT space | 5 | 4 | | | |

| SJMP | | Short JUMP | CY | AC | N | OV | Z |
|-------------|-----|-------------------------------|--------------|--------------|---|----|---|
| | | | — | — | — | — | — |
| Mnemonic | | Description | Bytes Binary | Bytes Source | | | |
| SJMP | rel | Short jump (relative address) | 2 | 2 | | | |

| 251 ONLY | SLL | | SHIFT Register Left | CY | AC | N | OV | Z |
|----------|------------|--------------------------|---------------------|--------------|--------------|---|----|---|
| | | | | X | — | X | — | X |
| | Mnemonic | | Description | Bytes Binary | Bytes Source | | | |
| SLL | Rm | Shift byte register left | 3 | 2 | | | | |
| SLL | WRj | Shift word register left | 3 | 2 | | | | |

| 251 ONLY | SRA | | SHIFT Register Right (arithmet.) sign extended | CY | AC | N | OV | Z |
|----------|------------|--|---|--------------|--------------|---|----|---|
| | | | | X | — | X | — | X |
| | Mnemonic | | Description | Bytes Binary | Bytes Source | | | |
| SRA | Rm | Shift byte register right; sign extended | 3 | 2 | | | | |
| SRA | WRj | Shift word register right; sign extended | 3 | 2 | | | | |

| | | | | | | | | |
|-----------------|-----------------|-----|---|---------------------|----------------|---------------------|----------------|---------------|
| 251 ONLY | SRL | | SHIFT Register Right (logic) zero extended | CY X | AC — | N X | OV — | Z X |
| | Mnemonic | | Description | Bytes Binary | | Bytes Source | | |
| | SRL | Rm | Shift byte register right; zero extended | 3 | | 2 | | |
| | SRL | WRj | Shift word register right; zero extended | 3 | | 2 | | |

| | | | | | | | | |
|-----------------|-----------------|-------------|--|---------------------|----------------|---------------------|----------------|---------------|
| 251 ONLY | SUB | | SUB destination, source Subtraction | CY X | AC X | N X | OV X | Z X |
| | Mnemonic | | Description | Bytes Binary | | Bytes Source | | |
| | SUB | Rm,Rm | Subtract byte register from byte register | 3 | | 2 | | |
| | SUB | WRj,WRj | Subtract word register from word register | 3 | | 2 | | |
| | SUB | DRk,DRk | Subtract dword register from dregister | 3 | | 2 | | |
| | SUB | Rm,#data | Subtract 8 bit data from byte register | 4 | | 3 | | |
| | SUB | Wrj,#data16 | Subtract 16 bit data from word register | 5 | | 4 | | |
| | SUB | Drk,#data16 | Subtract 16 bit unsigned data from dword reg. | 5 | | 4 | | |
| | SUB | Rm,dir | Subtract direct address from byte register | 4 | | 3 | | |
| | SUB | Wrj,dir | Subtract direct address from word register | 4 | | 3 | | |
| | SUB | Rm,dir16 | Subtract direct address (64K) from byte register | 5 | | 4 | | |
| | SUB | Wrj,dir16 | Subtract direct address (64K) from word register | 5 | | 4 | | |
| | SUB | Rm,@WRj | Subtract indirect address (64K) from byte reg. | 4 | | 3 | | |
| | SUB | Rm,@DRk | Subtract indirect address (16M) from byte reg. | 4 | | 3 | | |

| SUBB | | SUBB destination, source Subtraction with Borrow | CY X | AC X | N X | OV X | Z X |
|-----------------|----------|---|---------------------|----------------|---------------------|----------------|---------------|
| Mnemonic | | Description | Bytes Binary | | Bytes Source | | |
| SUBB | A,Rn | Subtract register from accumulator with borrow | 1 | | 2 | | |
| SUBB | A,dir8 | Subtract direct byte from accumulator with borrow | 2 | | 2 | | |
| SUBB | A,@Ri | Subtract indirect byte from accumulator with borrow | 1 | | 2 | | |
| SUBB | A,#data8 | Subtract immediate data from accumulator with borrow | 2 | | 2 | | |

| SWAP | | SWAP Nibbles within the Accumulator | CY — | AC — | N X | OV — | Z X |
|-----------------|---|--|---------------------|----------------|---------------------|----------------|---------------|
| Mnemonic | | Description | Bytes Binary | | Bytes Source | | |
| SWAP | A | Swap nibbles within the accumulator | 1 | | 1 | | |

| 251 ONLY | TRAP | | JUMP to the Trap Interrupt | | | CY — | AC — | N — | OV — | Z — |
|----------|-----------------|--|------------------------------------|--|--|---------------------|----------------|---------------------|----------------|---------------|
| | Mnemonic | | Description | | | Bytes Binary | | Bytes Source | | |
| | TRAP | | Jumps to the trap interrupt vector | | | 2 | | 1 | | |

| XCH | | EXCHANGE Operands | CY — | AC — | N — | OV — | Z — |
|-----------------|--------|---|---------------------|----------------|---------------------|----------------|---------------|
| Mnemonic | | Description | Bytes Binary | | Bytes Source | | |
| XCH | A,Rn | Exchange register with accumulator | 2 | | 2 | | |
| XCH | A,dir8 | Exchange direct byte with accumulator | 2 | | 2 | | |
| XCH | A,@Ri | Exchange indirect byte with accumulator | 1 | | 2 | | |

| XCHD | | EXCHANGE Digit | CY — | AC — | N — | OV — | Z — |
|-----------------|-------|---|---------------------|----------------|---------------------|----------------|---------------|
| Mnemonic | | Description | Bytes Binary | | Bytes Source | | |
| XCHD | A,@Ri | Exchange low-order digit in indir. RAM with accumulator | 1 | | 2 | | |

| XRL | | EXCL.-OR destination, source Logical Exclusive-OR | CY — | AC — | N X | OV — | Z X |
|-----------------|-------------|--|---------------------|----------------|---------------------|----------------|---------------|
| Mnemonic | | Description | Bytes Binary | | Bytes Source | | |
| XRL | A,Rn | Exclusive-OR register to accumulator | 1 | | 2 | | |
| XRL | A,dir8 | Exclusive-OR direct byte to accumulator | 2 | | 2 | | |
| XRL | A,@Ri | Exclusive-OR indirect byte to accumulator | 1 | | 2 | | |
| XRL | A,#data8 | Exclusive-OR immediate data to accumulator | 2 | | 2 | | |
| XRL | dir8,A | Exclusive-OR accumulator to direct byte | 2 | | 2 | | |
| XRL | dir8,#data8 | Exclusive-OR immediate data to direct byte | 3 | | 3 | | |
| 251 ONLY | XRL | Rm,Rm | 3 | | 2 | | |
| | XRL | WRj,WRj | 3 | | 2 | | |
| | XRL | Rm,#data8 | 4 | | 3 | | |
| | XRL | WRj,#data16 | 5 | | 4 | | |
| | XRL | Rm,dir8 | 4 | | 3 | | |
| | XRL | WRj,dir8 | 4 | | 3 | | |
| | XRL | Rm,dir16 | 5 | | 4 | | |
| | XRL | WRj,dir16 | 5 | | 4 | | |
| | XRL | Rm,@WRj | 4 | | 3 | | |
| | XRL | Rm,@DRk | 4 | | 3 | | |

Opcode Map

The following opcode maps provide an overview of the instruction encoding for the 8051, the 80C51MX, and the 251 architecture. It is arranged as separate maps as described below:

2

8051 Instructions: these opcode are available on all **x51** variants. Both the Philips 80C51MX and the Intel/Atmel WM 251 use an **OPCODE PREFIX** byte with the encoding A5 to extend the classic 8051 instruction set. The additional 251 an 80C51MX instructions are described in the following tables.

Additional 251 Instructions: if the 251 is configured in binary mode the **8051 instructions** are the default opcode map and the **OPCODE PREFIX** is the first opcode byte for the additional 251 instructions. If the 251 is configured in source mode the additional 251 instructions are the default opcode map and the **OPCODE PREFIX** is the first op-code byte when the 251 should execute standard 8051 instructions that are encode with the byte values x6-xF.

Additional 80C51MX Instructions via Prefix A5: contains the 80C51MX instructions that require the **OPCODE PREFIX** byte. The Philips 80C51MX provides instructions for addressing the 16MB address space and the extended SFR area that are listed in this table.

8051 Instructions

| Binary Mode | x0 | x1 | x2 | x3 | x4 | x5 | x6-x7 | x8-xF |
|-------------|------------------|----------------|----------------|-------------------|-------------------|-------------------|---------------------|--------------------|
| Source Mode | x0 | x1 | x2 | x3 | x4 | x5 | A5x6-A5x7 | A5x8-A5xF |
| 0x | NOP | AJMP adr11 | LJMP adr16 | RR A | INC A | INC dir | INC @Ri | INC Rn |
| 1x | JBC bit,rel | ACALL adr11 | LCALL adr16 | RRC A | DEC A | DEC dir | DEC @Ri | DEC Rn |
| 2x | JB bit,rel | AJMP adr11 | RET | RL A | ADD A,#data | ADD A,dir | ADD A,@Ri | ADD A,Rn |
| 3x | JNB bit,rel | ACALL adr11 | RETI | RLC A | ADDC A,#data | ADDC A,dir | ADDC A,@Ri | ADDC A,Rn |
| 4x | JC rel | AJMP adr11 | ORL dir,A | ORL dir,#data | ORL A,#data | ORL A,dir | ORL A,@Ri | ORL A,Rn |
| 5x | JNC rel | ACALL adr11 | ANL dir,A | ANL dir,#data | ANL A,#data | ANL A,dir | ANL A,@Ri | ANL A,Rn |
| 6x | JZ rel | AJMP adr11 | XRL dir,A | XRL dir,#data | XRL A,#data | XRL A,dir | XRL A,@Ri | XRL A,Rn |
| 7x | JNZ rel | ACALL adr11 | ORL c,bit | JMP @A+DPTR | MOV A,#data | MOV dir,#data | MOV @Ri,#data | MOV Rn,#data |
| 8x | SJMP rel | AJMP adr11 | ANL C,bit | MOVC A,@A+PC | DIV AB | MOV dir,dir | MOV dir,@Ri | MOV dir,Rn |
| 9x | MOV DPTR,#d16 | ACALL adr11 | MOV bit,c | MOVC A,@A+DPTR | SUBB A,#data | SUBB A,dir | SUBB A,@Ri | SUBB A,Rn |
| Ax | ORL C,/bit | AJMP adr11 | MOV C,bit | INC DPTR | MUL AB | OPCODE PREFIX | MOV @Ri,dir | MOV Rn,dir |
| Bx | ANL C,/bit | ACALL adr11 | CPL bit | CPL C | CJNE A,#d8,rel | CJNE A,dir,rel | CJNE @Ri,#d8,rel | CJNE Rn,#d8,rel |
| Cx | PUSH dir | AJMP adr11 | CLR bit | CLR C | SWAP A | XCH A,dir | XCH A,@Ri | XCH A,Rn |
| Dx | POP dir | ACALL adr11 | SETB bit | SETB C | DA A | DJNZ dir,rel | XCHD A,@Ri | DJNZ Rn,rel |
| Ex | MOVX A,@DPTR | AJMP adr11 | MOVX A,@Ri | | CLR A | MOV A,dir | MOV A,@Ri | MOV A,Rn |
| Fx | MOV @DPTR,A | ACALL adr11 | MOVX @Ri,A | | CPL A | MOV dir,A | MOV @Ri,A | MOV Rn,A |

Additional 80C51MX Instructions via Prefix A5

| | A5x0 | A5x1 | A5x2 | A5x3 | A5x4 | A5x5 | A5x6-A5x7 | A5x8-A5xF | A5x8-A5xF |
|----|------------------|------|----------------|-------------------|------|--------------------|-----------------|-------------------|-------------------|
| 0x | | | EJMP adr23 | | | INC esfr | | | |
| 1x | JBC esbit,rel | | ECALL adr23 | | | DEC esfr | | | |
| 2x | JB esbit,rel | | | | | ADD A,esfr | | | |
| 3x | JNB esbit,rel | | | | | ADDC A,esfr | | | |
| 4x | | | ORL esfr,A | ORL esfr,#data | | ORL A,esfr | | EMOV A,@PR0+d2 | EMOV A,@PR1+d2 |
| 5x | | | ANL esfr,A | ANL esfr,#data | | ANL A,esfr | | EMOV @PR0+d2,A | EMOV @PR1+d2,A |
| 6x | | | XRL esfr,A | XRL esfr,#data | | XRL A,esfr | | ADD PR0,#data2 | ADD PR1,#data2 |
| 7x | | | ORL c,esbit | EJMP @A+EPTR | | MOV dir,#data | | | |
| 8x | | | ANL C,esbit | | | MOV esfr,esfr | MOV esfr,@Ri | MOV esfr,Rn | |
| 9x | MOV EPTR,#d23 | | MOV esbit,c | MOVC A,@A+EPTR | | SUBB A,esfr | | | |
| Ax | ORL C,/esbit | | MOV C,esbit | INC EPTR | | | MOV @Ri,esfr | MOV Rn,esfr | |
| Bx | ANL C,/esbit | | CPL esbit | | | CJNE A,esfr,rel | | | |
| Cx | PUSH esfr | | CLR esbit | | | XCH A,esfr | | | |
| Dx | POP esfr | | SETB esbit | | | DJNZ esfr,rel | | | |
| Ex | MOVX A,@EPTR | | | | | MOV A,esfr | | | |
| Fx | MOV @EPTR,A | | | | | MOV esfr,A | | | |

2

Chapter 3. Writing Assembly Programs

The **Ax51** macro assembler is a multi pass assembler that translates **x51** assembly language programs into object files. These object files are then combined or linked using the **Lx51** Linker/Locator to form an executable, ready to run, absolute object module. As a subsequent step, absolute object modules can be converted to Intel HEX files suitable for loading onto to your target hardware, device programmer, or ICE (In-Circuit Emulator) unit.

The following sections describe the components of an assembly program, and some aspects of writing assembly programs. An assembly program consists of one or more statements. These statements contain directives, controls, and instructions.

3

Assembly Statements

Assembly program source files are made up of statements that may include assembler controls, assembler directives, or **x51** assembly language instructions (mnemonics). For example:

```
$TITLE(Demo Program #1)
      CSEG      AT      0000h
      JMP      $
      END
```

This example program consists of four statements. **\$TITLE** is an assembler control, **CSEG** and **END** are assembler directives, and **JMP** is an assembly language instruction.

Each line of an assembly program can contain only one control, directive, or instruction statement. Statements must be contained in exactly one line. Multi-line statements are not allowed.

Statements in **x51** assembly programs are not column sensitive. Controls, directives, and instructions may start in any column. Indentation used in the examples in this manual, is done for program clarity and is neither required nor expected by the assembler. The only exception is that arguments and instruction operands must be separated from controls, directives, and instructions by at least one space.

Shaded directives and options are available only in AX51 and A251.

All **x51** assembly programs must include the **END** directive. This directive signals to the assembler that this is the end of the assembly program. Any instructions, directives, or controls found after the **END** directive are ignored. The shortest valid assembly program contains only an **END** directive.

Directives

Assembler directives instruct the assembler how to process subsequent assembly language instructions. Directives also provide a way for you to define program constants and reserve space for variables.

“Chapter 4. Assembler Directives” on page 99 provides complete descriptions and examples of all of the assembler directives that you may include in your program. Refer to this chapter for more information about how to use directives.

Controls

Assembler controls direct the operation of the assembler when generating a listing file or object file. Typically, controls do not impact the code that is generated by the assembler. Controls can be specified on the command line or within an assembler source file.

The conditional assembly controls are the only assembler controls that will impact the code that is assembled by the **Ax51** assembler. The **IF**, **ELSE**, **ENDIF**, and **ELSEIF** controls provide a powerful set of conditional operators that can be used to include or exclude certain parts of your program from the assembly.

“Chapter 7. Invocation and Controls” on page 195 describes the available assembler controls in detail and provides an example of each. Refer to this chapter for more information about control statements.

Instructions

Assembly language instructions specify the program code that is to be assembled by the **Ax51** assembler. The **Ax51** assembler translates the assembly

Shaded directives and options are available only in AX51 and A251.

instructions in your program into machine code and stores the resulting code in an object file.

Assembly instructions have the following general format:

```
[label:] mnemonic [operand] [, operand] [, operand] [; comment]
```

where

| | |
|-----------------|---|
| <i>label</i> | is a symbol name that is assigned the address at which the instruction is located. |
| <i>mnemonic</i> | is the ASCII text string that symbolically represents a machine language instruction. |
| <i>operand</i> | is an argument that is required by the specified <i>mnemonic</i> . |
| <i>comment</i> | is an optional description or explanation of the instruction. A comment may contain any text you wish. Comments are ignored by the assembler. |

The “Instruction Sets” of the **x51** microcontrollers are listed on page 40 by mnemonic and by machine language opcode. Refer to this section for more information about assembler instructions.

Comments

Comments are lines of text that you may include in your program to identify and explain the program. Comments are ignored by the **Ax51** assembler and are not required in order to generate working programs.

You can include comments anywhere in your assembler program. Comments must be preceded with a semicolon character (;). A comment can appear on a line by itself or can appear at the end of an instruction. For example:

```
;This is a comment
NOP                ;This is also a comment
```

When the assembler recognizes the semicolon character on a line, it ignores subsequent text on that line. Anything that appears on a line to the right of a semicolon will be ignored by the **Ax51** assembler. Comments have no impact on object file generation or the code contained therein.

Shaded directives and options are available only in AX51 and A251.

Symbols

A symbol is a name that you define to represent a value, text block, address, or register name. You can also use symbols to represent numeric constants and expressions.

Symbol Names

Symbols are composed of up to 31 characters from the following list:

A - Z, a - z, 0 - 9, _, and ?

A symbol name can start with any of these characters *except* the digits 0 - 9.

Symbols can be defined in a number of ways. You can define a symbol to represent an expression using the **EQU** or **SET** directives:

```
NUMBER_FIVE      EQU      5
TRUE_FLAG        SET      1
FALSE_FLAG       SET      0
```

You can define a symbol to be a label in your assembly program:

```
LABEL1:          DJNZ     R0, LABEL1
```

You can define a symbol to refer to a variable location:

```
SERIAL_BUFFER    DATA    99h
```

Symbols are used throughout assembly programs. A symbolic name is much easier to understand and remember than an address or numeric constant. The following sections provide more information about how to use and define symbols.

Shaded directives and options are available only in AX51 and A251.

Labels

A label defines a “place” (an address) in your program or data space. All rules that apply to symbol names also apply to labels. When defined, a label must be the first text field in a line. It may be preceded by tabs or spaces. A colon character (:) must immediately follow the symbol name to identify it as a label. Only one label may be defined on a line. For example:

```
LABEL1:      DS      2
LABEL2:      ;label by itself
NUMBER:     DB      27, 33, 'STRING', 0 ;label at a message
COPY:       MOV     R6, #12H           ;label in a program
```

In the above examples, LABEL1, LABEL2, NUMBER, and COPY are all labels.

When a label is defined, it receives the current value of the location counter of the currently selected segment. Refer to “Location Counter” on page 87 for more information about the location counter.

You can use a label just like you would use a program offset within an instruction. Labels can refer to program code, to variable space in internal or external data memory, or can refer to constant data stored in the program or code space.

You can use a label to transfer program execution to a different location. The instruction immediately following a label can be referenced by using the label. Your program can jump to or make a call to the label. The code immediately following the label will be executed.

You can also use labels to provide information to simulators and debuggers. A simulator or debugger can provide the label symbols while debugging. This can help to simplify the debugging process.

Labels may only be defined once. They may not be redefined.

Shaded directives and options are available only in AX51 and A251.

Operands

Operands are arguments, or expressions, that are specified along with assembler directives or instructions. Assembler directives require operands that are constants or symbols. For example:

```

VVV          EQU    3
              DS     10h
  
```

Assembler instructions support a wider variety of operands than do directives. Some instructions require no operands and some may require up to 3 operands. Multiple operands are separated by commas. For example:

```

MOV          R2, #0
  
```

The number of operands that are required and their types depend on the instruction or directive that is specified. In the following table the first four operands can also be expressions. Instruction operands can be classified as one the following types:

| Operand Type | Description |
|--------------------------|--|
| Immediate Data | Symbols or constants the are used as an numeric value. |
| Direct Bit Address | Symbols or constants that reference a bit address. |
| Program Addresses | Symbols or constants that reference a code address. |
| Direct Data Addresses | Symbols or constants that reference a data address. |
| Indirect Addresses | Indirect reference to a memory location, optionally with offset. |
| Special Assembler Symbol | Register names. |

Shaded directives and options are available only in AX51 and A251.

Special Assembler Symbols

The **Ax51** assembler defines and reserves names of the **x51** register set. These predefined names are used in **x51** programs to access the processor registers. Following, is a list of each of the 8051, 80C51MX, and 251 registers along with a brief description:

| Register | Description | |
|------------------|--|---|
| A | Represents the 8051 Accumulator. It is used with many operations including multiplication and division, moving data to and from external memory, Boolean operations, etc. | |
| DPTR | The DPTR register is a 16-bit data pointer used to address data in XDATA or CODE memory. | |
| PC | The PC register is the 16-bit program counter. It contains the address of the next instruction to be executed. | |
| C | The Carry flag; indicates the status of operations that generate a carry bit. It is also used by operations that require a borrow bit. | |
| AB | The A and B register pair used in MUL and DIV instructions. | |
| R0 – R7 | The eight 8-bit general purpose 8051 registers in the currently active register bank. A Maximum of four register banks are available. | |
| AR0 – AR7 | Represent the absolute data addresses of R0 through R7 in the current register bank. The absolute address for these registers will change depending on the register bank that is currently selected. These symbols are only available when the USING directive is given. Refer to the USING directive for more information on selecting the register bank. These representations are suppressed by the NOAREGS directive. Refer to the NOAREGS directive for more information. | |
| 51MX ONLY | PR0, PR1 | Universal Pointer Registers of the 80C51MX architecture. Universal Pointer can access the complete 16MB address space of the 80C51MX. PR0 is composed of registers R1, R2, and R3. PR1 is composed of registers R5, R6, and R7. |
| | EPTR | Additional extended data pointer register of the 80C51MX architecture. EPTR may be used to access the complete memory space. |
| 251 ONLY | R8 – R15 | Additional eight 8-bit general purpose registers of the 251. |
| | WR0 – WR30 | Sixteen 16-bit general purpose registers of the 251. The registers WR0 - WR14 overlap the registers R0 - R15. Note that there is no WR1 available. |
| | DR0 – DR28 DR56, DR60 | Ten 32-bit general purpose registers of 251. The registers DR0 - DR28 overlap the registers WR0 - WR30. Note that there is no DR1, DR2 and DR3 available. |

Immediate Data

An immediate data operand is a numeric expression that is encoded as a part of the machine language instruction. Immediate data values are used literally in an instruction to change the contents of a register or memory location. The pound (or number) sign (#) must precede any expression that is to be used as an immediate data operand. The following shows some examples of how the immediate data is typically used:

```

MY_VAL    EQU    50H        ; an equate symbol

          MOV    A,IO_PORT2  ; direct memory access to DATA
          MOV    A,#0E0h     ; load 0xE0 into the accumulator
          MOV    DPTR,#0x8000 ; load 0x8000 into the data pointer
          ANL   A,#128       ; AND the accumulator with 128
          XRL   A,#0FFh      ; XOR A with 0ffh
          MOV    R5,#MY_VAL   ; load R5 with the value of MY_VAL

```

3

Memory Access

A memory access reads or writes a value in to the various memory spaces of the **x51** system.

Direct memory access encodes the memory address in the instruction that to reads or writes the memory. With direct memory accesses you can access variables in the memory class DATA and BIT. For the 251 also the EDATA memory class is addressable with direct memory accesses.

Indirect memory accesses uses the content of a register in the instruction that reads or writes into the memory. With indirect address operands it is possible to access all memory classes of the **x51**.

The following examples show how to access the different memory classes of an **x51** system.

Shaded directives and options are available only in AX51 and A251.

DATA

Memory locations in the memory class DATA can be addressed with both: direct and indirect memory accesses. Special Function Registers (SFR) of the **x51** have addresses above 0x80 in the DATA memory class. SFR locations can be addressed only with direct memory accesses. An indirect memory access to SFRs is not supported in the **x51** microcontrollers.

Example for all 8051 variants

```
?DT?myvar SEGMENT DATA ; define a SEGMENT of class DATA
          RSEG ?DT?myvar
VALUE:    DS 1 ; reserve 1 BYTE in DATA space

IO_PORT2 DATA 0A0H ; special function register
VALUE2   DATA 20H ; absolute memory location

?PR?myprog SEGMENT CODE ; define a segment for program code
          RSEG ?PR?myprog
          MOV A,IO_PORT2 ; direct memory access to DATA
          ADD A,VALUE
          MOV VALUE2,A
          MOV R1,#VALUE ; load address of VALUE to R1
          ADD A,@R1 ; indirect memory access to VALUE
```

3

BIT

Memory locations in the memory class BIT are addressed with the bit instructions of the 8051. Also the Special Function Registers (SFR) that are located bit-addressable memory locations can be addressed with bit instructions. Bit-addressable SFR locations are: 80H, 88H, 90H, 98H, 0A0H, 0A8H, 0B0H, 0B8H, 0C0H, 0C8H, 0D0H, 0D8H, 0E0H, 0E8H, 0F0H, and 0F8H.

Example for all 8051 variants

```
?BI?mybits SEGMENT BIT ; define a SEGMENT of class BIT
          RSEG ?BI?mybits
FLAG:     DBIT 1 ; reserve 1 Bit in BIT space
P1        DATA 90H ; 8051 SFR PORT1
GREEN_LED BIT P1.2 ; GREEN LED on I/O PORT P1.2

?PR?myprog SEGMENT CODE ; define a segment for program code
          RSEG ?PR?myprog
          SETB GREEN_LED ; P1.2 = 1
          JB FLAG,is_on ; direct memory access to DATA
          SETB FLAG
          CLR ACC.5 ; reset bit 5 in register A
          :
is_on:    CLR FLAG
          CLR GREEN_LED ; P1.2 = 0
```

Shaded directives and options are available only in AX51 and A251.

EBIT (only on Intel/Atmel WM 251)

The 251 provides with the EBIT memory class an expanded bit-addressable memory space that is addressed with extended bit instructions. Also all Special Function Registers (SFR) in the 251 can be addressed with extended bit instructions.

Example for Intel/Atmel WM 251

```
?EB?mybits SEGMENT EBIT          ; define a SEGMENT of class EBIT
            RSEG   ?EB?mybits
FLAG:      DBIT   1                ; reserve 1 Bit in BIT space
CMOD      DATA  0D9H            ; PCA Counter Modes
CPS0      BIT    CMOD.1          ; CPS0 bit

?PR?myprog SEGMENT CODE          ; define a segment for program code
            RSEG   ?PR?myprog
            JB     FLAG,is_on     ; direct memory access to DATA
            SETB  FLAG
            :
is_on:     CLR    FLAG
            CLR    CPS0          ; CMOD.1 = 0
```

IDATA

Variables in this memory class are accessed via registers R0 or R1.

Example for all 8051 variants

```
?ID?myvars SEGMENT IDATA        ; define a SEGMENT of class IDATA
            RSEG   ?EB?mybits
BUFFER:    DS     100            ; reserve 100 Bytes

?PR?myprog SEGMENT CODE          ; define a segment for program code
            RSEG   ?PR?myprog
            MOV    R0,#BUFFER    ; load the address in R0
            MOV    A,@R0        ; read memory location buffer
            INC    R0            ; increment memory address in R0
            MOV    @R0,A        ; write memory location buffer+1
```

Shaded directives and options are available only in AX51 and A251.

EDATA (Intel/Atmel WM 251, Philips 80C51MX only)

The EDATA memory is only available in the Philips 80C51MX and the Intel/Atmel WM 251 architecture.

In the Philips 80C51MX, the EDATA memory can be accessed via EPTR or the Universal Pointers PR0 and PR1. Universal Pointers can access any memory location in the 16MB address space.

Example for Philips 80C51MX

```
?ED?my_seg SEGMENT EDATA          ; define a SEGMENT of class EDATA
             RSEG   ?ED?my_seg
STRING:     DS      100            ; reserve 100 Bytes

?PR?myprog SEGMENT CODE           ; define a segment for program code
             RSEG   ?PR?myprog
MOV         R1,#BYTE0 STRING     ; load address of STRING in PR0
MOV         R2,#BYTE1 STRING
MOV         R3,#BYTE2 STRING
MOV         A,@PR0               ; load first byte of STRING in A
```

3

In the 251, EDATA memory can be accessed with direct memory addressing or indirect via the registers WR0 .. WR30. Also the memory class IDATA and DATA can be access with this addressing mode.

Example for Intel/Atmel WM 251

```
?ED?my_seg SEGMENT EDATA          ; define a SEGMENT of class EDATA
             RSEG   ?ED?my_seg
STRING:     DS      100            ; reserve 100 Bytes

?PR?myprog SEGMENT CODE           ; define a segment for program code
             RSEG   ?PR?myprog
MOV         R11,STRING+2         ; load character at STRING[2]
MOV         WR4,#STRING          ; load address of STRING
MOV         R6,@WR4              ; indirect access
MOV         @WR4+2,R6            ; access with constant offset
```

Shaded directives and options are available only in AX51 and A251.

XDATA

The XDATA memory class can be accessed with the instruction MOVX via the register DPTR. A single page of the XDATA memory can be also accessed or via the registers R0, R1. At the C Compiler level this memory type is called **pdata** and the segment prefix ?PD? is used. The high address for this pdata page is typically set with the P2 register. But in new 8051 variants there are also dedicated special function registers that define the XDATA page address.

Example for all 8051 variants

```
?XR?my_seg SEGMENT XDATA                ; define a SEGMENT of class XDATA
             RSEG  ?ED?my_seg
XBUFFER:    DS      100                  ; reserve 100 Bytes

?PD?myvars  SEGMENT XDATA INPAGE         ; define a paged XDATA segment
             RSEG  ?PD?myvars
VAR1:       DS      1                    ; reserve 1 byte

?PR?myprog  SEGMENT CODE                 ; define a segment for program code
             RSEG  ?PR?myprog
             MOV   P2,#HIGH ?PD?myvars  ; load page address register
             :
             MOV   DPTR,#XBUFFER        ; load address
             MOVX  A,@DPTR              ; access via DPTR
             MOV   R1,#VAR1             ; load address
             MOVX  @R1,A                ; access via R0 or R1
```

CODE and CONST

CODE or CONST memory can be accessed with the instruction MOVC via the DPTR register. The memory class CONST not possible with A51 and BL51.

Example for all 8051 variants

```
?CO?my_seg SEGMENT CODE                 ; define a SEGMENT of class CODE
             RSEG  ?CO?my_seg
TABLE:      DB      1,2,4,8,0x10        ; a table with constant values

?PR?myprog  SEGMENT CODE                 ; define a segment for program code
             RSEG  ?PR?myprog
             MOV   DPTR,#TABLE          ; load address of table
             MOV   A,#3                 ; load offset into table
             MOVC  A,@A+DPTR           ; access via MOVC instruction
```

Shaded directives and options are available only in AX51 and A251.

HDATA and HCONST

The HDATA and HCONST memory can be accessed with CPU instructions only in the Philips 80C51MX and the 251 architecture. HDATA and HCONST memory is simulated with memory banking on classic 8051 devices. The HDATA and HCONST memory class is not possible with A51 and BL51.

In the Philips 80C51MX, the HDATA and HCONST memory can be accessed via EPTR or the Universal Pointers PR0 and PR1. Universal Pointers can access any memory location in the 16MB address space.

Example for Philips 80C51MX

```
?HD?my_seg SEGMENT HDATA                ; define a SEGMENT of class HDATA
             RSEG ?HD?my_seg
ARRAY:      DS 100                        ; reserve 100 Bytes

?PR?myprog SEGMENT CODE                  ; define a segment for program code
             RSEG ?PR?myprog
             MOV R1,#BYTE0 ARRAY        ; load address of ARRAY in PR0
             MOV R2,#BYTE1 ARRAY
             MOV R3,#BYTE2 ARRAY
             MOV A,@PR0                  ; load first byte of ARRAY in A
```

In the 251, HDATA and HCONST memory can be accessed via the registers DR0 .. DR28 and DR56. Any memory location can be accessed with this registers.

Example for Intel/Atmel WM 251

```
?HD?my_seg SEGMENT HDATA                ; define a SEGMENT of class HDATA
             RSEG ?HD?my_seg
ARRAY:      DS 100                        ; reserve 100 Bytes

?PR?myprog SEGMENT CODE                  ; define a segment for program code
             RSEG ?PR?myprog
             MOV WR8,#WORD2 ARRAY       ; load address of ARRAY
             MOV WR10,#WORD0 ARRAY      ; into DR8
             MOV R4,@DR8                 ; indirect access
             MOV @DR8+50H,R4             ; access with constant offset
```

Shaded directives and options are available only in AX51 and A251.

Program Addresses

Program addresses are absolute or relocatable expressions with the memory class CODE or ECODE. Typically program addresses are used in jump and call instructions. For indirect jumps or calls it is required to load a program address in a register or a jump table. The following jumps and calls are possible:

SJMP **Relative jumps** include conditional jumps (**CJNE**, **DJNZ**, **JB**, **JBC**, **JZ**, **JC**, ...) and the unconditional **SJMP** instruction. The addressable offset is -128 to $+127$ bytes from the first byte of the instruction that follows the relative jump. When you use a relative jump in your code, you must use an expression that evaluates to the code address of the jump destination. The assembler does all the offset computations. If the address is out of range, the assembler will issue an error message.

ACALL **In-block jumps and calls** permit access only within a 2KByte block of program space. The low order 11 bits of the program counter are replaced when the jump or call is executed. For Dallas 390 contiguous mode the block size is 512KB or 19 bits. If **ACALL** or **AJMP** is the last instruction in a block, the high order bits of the program counter change and the jump will be within the block following the **ACALL** or **AJMP**.

LCALL **Long jumps and calls** allow access to any address within a 64KByte segment of program space. The low order 16 bits of the program counter are replaced when the jump or call is executed. For Dallas 390 contiguous mode: the block size is 16MB or 24 bits. One Philips 80C51MX and Intel/Atmel WM 251: if **LCALL** or **LJMP** is the last instruction in a 64KByte segment, the high order bits of the program counter change and the jump will into the segment following the **LCALL** or **LJMP**.

ECALL **Extended jumps and calls** allow access within the extended program space of the Intel/Atmel WM 251 or Philips 80C51MX.

CALL **Generic jumps and calls** are two instruction mnemonics that do not represent a specific opcode. **JMP** may assemble to **SJMP**, **AJMP**, **LJMP** or **EJMP**. **CALL** may assemble to **ACALL**, **LCALL** or **ECALL**. These generic mnemonics always evaluate to an instruction, not necessarily the shortest, that will reach the specified program

address operand.

Example for all 8051 Variants

```

EXTRN CODE (my_function)

        CSEG      AT      3
        JMP       ext_int          ; an interrupt vector

?PR?myintr SEGMENT CODE          ; define a segment for program code
        RSEG     ?PR?myintr
ext_int: JB       FLAG,flag_OK
        INC      my_var
flag_OK: CPL      FLAG
        RETI

?PR?myprog SEGMENT CODE INBLOCK  ; a segment within a 2K block
        RSEG     ?PR?myprog
func1:   CALL    sub_func          ; will generate ACALL
loop:   CALL    my_function        ; external function -> LCALL
        MOV     A,my_var
        JNZ    loop
        RET

sub_func: CLR     FLAG
        MOV     R0,#20
loop1:  CALL    my_function
        DJNZ   R0,loop1
        RET

```

3

Example with EJMP, ECALL for Philips 80C51MX and Intel/Atmel WM 251

```

EXTRN ECODE:FAR (my_farfunc)

Reset   EQU      ECODE 0FF0000H    ; Reset location on 251

?PR?my_seg SEGMENT ECODE          ; define a SEGMENT of class EDATA
        RSEG     ?PR?my_seg

func1   PROC     FAR              ; far function called with ECALL
        CALL    func2            ; generates LCALL
        CALL    my_farfunc       ; generates ECALL
        JNB    Flag,mylab
        EJMP   Reset
mylab:  ERET
        ENDP

func2   PROC     NEAR
        CALL    my_farfunc       ; generates ECALL
        RET
        ENDP

```

Expressions and Operators

An operand may be a numeric constant, a symbolic name, a character string or an expression.

Operators are used to combine and compare operands within your assembly program. Operators are not assembly language instructions nor do they generate **x51** assembly code. They represent operations that are evaluated at assembly-time. Therefore, operators can only handle calculations of values that are known when the program is assembled.

3

An expression is a combination of numbers, character string, symbols, and operators that evaluate to a single 32-bit binary number (for A51: 16-bit binary number). Expressions are evaluated at assembly time and can, therefore, be used to calculate values that would otherwise be difficult to determine beforehand.

The following sections describe operators and expressions and how they are used in **x51** assembly programs.

Numbers

Numbers can be specified in hexadecimal (base 16), decimal (base 10), octal (base 8), and binary (base 2). The base of a number is specified by the last character in the number. A number that is specified without an explicit base is interpreted as decimal number.

The following table lists the base types, the base suffix character, and some examples:

| Base | Suffix | Legal Characters | Examples |
|-------------|------------|---------------------|-------------------------------|
| Hexadecimal | H, h | 0 – 9, A – F, a – f | 0x1234 0x99 1234H 0A0F0h 0FFh |
| Decimal | D, d | 0 – 9 | 1234 65590d 20d 123 |
| Octal | O, o, Q, q | 0 – 7 | 177o 25q 123o 177777q |
| Binary | B, b | 0 and 1 | 10011111b 101010101b |

The first character of a number must be a digit between 0 and 9. Hexadecimal numbers which do not have a digit as the first character should be prefixed with a 0. The **Ax51** assembler supports also hex numbers written in C notation.

The dollar sign character (\$) can be used in a number to make it more readable, however, the dollar sign character cannot be the first or last character in the number. A dollar sign used within a number is ignored by the assembler and has no impact on the value of the number. For example:

```
1111$0000$1010$0011b      is equivalent to      1111000010100011B
1$2$3$4                    is equivalent to      1234
```

Colon Notation for Numbers (A251 only)

The **A251** assembler supports the notation *page:number* for specifying absolute addresses. Numbers specified with this notation receive the memory type EDATA when page is 0 or ECODE for all other pages. In this way, you can use such numbers for referencing any memory location. For example:

```
ABSVAL1 EQU 0:20H      ; symbol to address location 20H
ABSVAL2 EQU 0:80H      ; symbol to address location 80H in EDATA space
PORT0 EQU S:80H        ; symbol to SFR space 80H
ENTRY EQU 10:2000H     ; entry point at location 102000H

MOV WR0,ABSVAL1
MOV R1,ABSVAL2
MOV PORT0,R1
EJMP ENTRY
MOV WR0,0:20H          ; access to ABSVAL1
MOV R1,0:80H           ; access to ABSVAL2
MOV S:80H,R1
EJMP 10:2000H
```

The colon notation is accepted in several A251 controls and is converted as described.

Shaded directives and options are available only in AX51 and A251.

| Number in Colon Notation | Replaced with |
|--------------------------|---|
| VAL1 EQU 0:20H | VAL1 EQU EDATA 20H |
| VAL2 EQU 0FF:1000H | VAL2 EQU ECODE 0FF1000H |
| ORG 0FE:2000H | ?modulename?number SEGMENT ECODE AT 0FE2000H RSEG ?modulename?number |
| ORG 0:400H | ?modulename?number SEGMENT EDATA AT 400H RSEG ?modulename?number |
| CSEG AT 0FE:2000H | ?modulename?number SEGMENT ECODE AT 0FE2000H RSEG ?modulename?number |
| BVAR1 BIT 0:20H.1 | BVAR1 BIT 20H.1 |
| BVAR1 BIT 0:30H.1 | BVAR1 EQU EBIT 30H.1 |
| PUSH.B #13 | PUSH BYTE #13 |
| PUSH.W #13 | PUSH WORD #13 |

NOTE

The colon notation is provided for source compatibility with other 251 macro assemblers. If you do not need to port your code to other assemblers, it is recommended to use directly the replacement sequence in your assembler source file.

Characters

The **Ax51** assembler allows you to use ASCII characters in an expression to generate a numeric value. Up to two characters enclosed within single quotes (') may be included in an expression. More than two characters in single quotes in an expression will cause the **Ax51** assembler to generate an error. Following are examples of character expressions:

```
'A'           evaluates to 0041h
'AB'          evaluates to 4142h
'a'           evaluates to 0061h
'ab'          evaluates to 6162h
''            null string evaluates to 0000h
'abc'         generates an ERROR
```

Characters may be used anywhere in your program as a immediate data operand. For example:

```
LETTER_A      EQU      'A'
TEST:         MOV      @R0, #'F'
              SUBB    A, #'0'
```

Shaded directives and options are available only in AX51 and A251.

Character Strings

Character strings can be used in combination with the **DB** directive to define messages that are used in your **x51** assembly program. Character strings must be enclosed within single quotes ('). For example:

```
KEYMSG:          DB      'Press any key to continue.'
```

generates the hexadecimal data (50h, 72h, 65h, 73h, 73h, 20h, ... 6Eh, 75h, 65h, 2Eh) starting at **KEYMSG**. You can mix string and numeric data on the same line. For example:

```
EOLMSG:          DB      'End of line', 00h
```

appends the value 00h to the end of the string 'End of line'.

Two successive single quote characters can be used to insert a single quote into a string. For example:

```
MSGTXT:          DB      'ISN''T A QUOTE REQUIRED HERE?'
```

Location Counter

The **Ax51** assembler maintains a location counter for each segment. The location counter contains the offset of the instruction or data being assembled and is incremented after each line by the number of bytes of data or code in that line.

The location counter is initialized to 0 for each segment, but can be changed using the **ORG** directive.

The dollar sign character (**\$**) returns the current value of the location counter. This operator allows you to use the location counter in an expression. For example, the following code uses **\$** to calculate the length of a message string.

```
MSG:             DB      'This is a message', 0
MSGLEN           EQU     $ - MSG
```

You can also use **\$** in an instruction. For example, the following line of code will repeat forever.

```
JMP      $      ; repeat forever
```

Shaded directives and options are available only in AX51 and A251.

Operators

The **AX51** assembler provides several classes of operators that allow you to compare and combine operands and expressions. These operators are described in the sections that follow.

Arithmetic Operators

Arithmetic operators perform arithmetic functions like addition, subtraction, multiplication, and division. These operators require one or two operands depending on the operation. The result is always a 16-bit value. Overflow and underflow conditions are not detected. Division by zero is detected and causes an assembler error.

| Operator | Syntax | Description |
|----------------|----------------------------------|----------------------------|
| + | <i>+ expression</i> | Unary plus sign |
| - | <i>- expression</i> | Unary minus sign |
| + | <i>expression + expression</i> | Addition |
| - | <i>expression - expression</i> | Subtraction |
| * | <i>expression * expression</i> | Multiplication |
| / | <i>expression / expression</i> | Integer division |
| MOD | <i>expression MOD expression</i> | Remainder |
| (and) | <i>(expression)</i> | Specify order of execution |

Binary Operators

Binary operators are used to complement, shift, and perform bit-wise operations on the binary value of their operands.

| Operator | Syntax | Description |
|------------|----------------------------------|-----------------------|
| NOT | <i>NOT expression</i> | Bit-wise complement |
| SHR | <i>expression SHR count</i> | Shift right |
| SHL | <i>expression SHL count</i> | Shift left |
| AND | <i>expression AND expression</i> | Bit-wise AND |
| OR | <i>expression OR expression</i> | Bit-wise OR |
| XOR | <i>expression XOR expression</i> | Bit-wise exclusive OR |

Shaded directives and options are available only in AX51 and A251.

Relational Operators

The relational operators compare two operands. The result of the comparison is a TRUE or FALSE. A FALSE result has a value of 0000h. A TRUE result has a non-zero value.

The following table lists the relational operators and provides a brief description of each.

| Operator | Syntax | Result |
|-----------------|---|---|
| GTE | <i>expression1</i> GTE <i>expression2</i> | True if <i>expression1</i> is greater than or equal to <i>expression2</i> |
| LTE | <i>expression1</i> LTE <i>expression2</i> | True if <i>expression1</i> is less than or equal to <i>expression2</i> |
| NE | <i>expression1</i> NE <i>expression2</i> | True if <i>expression1</i> is not equal to <i>expression2</i> |
| EQ | <i>expression1</i> EQ <i>expression2</i> | True if <i>expression1</i> is equal to <i>expression2</i> |
| LT | <i>expression1</i> LT <i>expression2</i> | True if <i>expression1</i> is less than <i>expression2</i> |
| GT | <i>expression1</i> GT <i>expression2</i> | True if <i>expression1</i> is greater than <i>expression2</i> |
| >= | <i>expression1</i> >= <i>expression2</i> | True if <i>expression1</i> is greater than or equal to <i>expression2</i> |
| <= | <i>expression1</i> <= <i>expression2</i> | True if <i>expression1</i> is less than or equal to <i>expression2</i> |
| <> | <i>expression1</i> <> <i>expression2</i> | True if <i>expression1</i> is not equal to <i>expression2</i> |
| = | <i>expression1</i> = <i>expression2</i> | True if <i>expression1</i> is equal to <i>expression2</i> |
| < | <i>expression1</i> < <i>expression2</i> | True if <i>expression1</i> is less than <i>expression2</i> |
| > | <i>expression1</i> > <i>expression2</i> | True if <i>expression1</i> is greater than <i>expression2</i> |

Class Operators

The class operator assigns a memory class to an expression. This is how you associate an expression with a class. The **Ax51** assembler generates an error message if you use an expression with a class on an instruction which does not support this class, for example, when you use an **XDATA** expression as a direct address.

The following table lists the class operators and provides a brief description of each.

| Operator | Syntax | Description |
|---------------|--------------------------|---|
| BIT | <i>BIT expression</i> | Assigns the class BIT to the expression. |
| CODE | <i>CODE expression</i> | Assigns the class CODE to the expression. |
| CONST | <i>CONST expression</i> | Assigns the class CONST to the expression. |
| DATA | <i>DATA expression</i> | Assigns the class DATA to the expression. |
| EBIT | <i>EBIT expression</i> | Assigns the class EBIT to the expression. |
| ECODE | <i>ECODE expression</i> | Assigns the class ECODE to the expression. |
| ECONST | <i>ECONST expression</i> | Assigns the class ECONST to the expression. |
| EDATA | <i>EDATA expression</i> | Assigns the class EDATA to the expression. |
| IDATA | <i>IDATA expression</i> | Assigns the class IDATA to the expression. |
| HCONST | <i>HCONST expression</i> | Assigns the class HCONST to the expression. |
| HDATA | <i>HDATA expression</i> | Assigns the class HDATA to the expression. |
| XDATA | <i>XDATA expression</i> | Assigns the class XDATA to the expression. |

Type Operators

The type operator assigns a data type to an expression. The **A251** assembler generates an error if you attempt to use an instruction with the incorrect data type. For example, this happens when you use a **WORD** expression as an argument in a byte-wide instruction of the 251.

| Operator | Syntax | Description |
|--------------|-------------------------|--|
| BYTE | <i>BYTE expression</i> | Assigns the type BYTE to the expression. |
| WORD | <i>WORD expression</i> | Assigns the class WORD to the expression. |
| DWORD | <i>DWORD expression</i> | Assigns the class DWORD to the expression. |
| NEAR | <i>NEAR expression</i> | Assigns the class NEAR to the expression. |
| FAR | <i>FAR expression</i> | Assigns the class FAR to the expression. |

Shaded directives and options are available only in **AX51** and **A251**.

Miscellaneous Operators

Ax51 provides operators that do not fall into the previously listed categories. These operators are listed and described in the following table.

| Operator | Syntax | Description |
|--------------|------------------|---|
| LOW | LOW expression | Low-order byte of expression |
| HIGH | HIGH expression | High-order byte of expression |
| BYTE0 | BYTE0 expression | Byte 0 of expression. See table below. (identical with LOW). |
| BYTE1 | BYTE1 expression | Byte 1 of expression. See table below. (identical with HIGH). |
| BYTE2 | BYTE2 expression | Byte 2 of expression. See table below. |
| BYTE3 | BYTE3 expression | Byte 3 of expression. See table below. |
| WORD0 | WORD0 expression | Word 0 of expression. See table below. |
| WORD2 | WORD2 expression | Word2 of expression. See table below. |
| MBYTE | MBYTE expression | AX51 only: memory type information for C51 run-time libraries. Returns the memory type that is used in the C51 run-time library to access variables defined with the far memory type. |

The following table shows how the byte and word operators impact a 32-bit value.

| MSB | | LSB | |
|-------|-------|-------|-------|
| BYTE3 | BYTE2 | BYTE1 | BYTE0 |
| WORD2 | | WORD0 | |
| | | HIGH | LOW |

The following table shows how the byte and word operators impact a 32-bit value.

Shaded directives and options are available only in AX51 and A251.

Operator Precedence

All operators are evaluated in a certain, well-defined order. This order of evaluation is referred to as operator precedence. Operator precedence is required in order to determine which operators are evaluated first in an expression. The following table lists the operators in the order of evaluation. Operators at level 1 are evaluated first. If there is more than one operator on a given level, the leftmost operator is evaluated first followed by each subsequent operator on that level.

| Level | Operators |
|-------|---|
| 1 | () |
| 2 | NOT, HIGH, LOW, BYTE0, BYTE1, BYTE2, BYTE3, WORD0, WORD2 |
| 3 | BIT, CODE, CONST, DATA, EBIT, EDATA, ECONST, ECODE, HCONST, HDATA, IDATA, XDATA |
| 4 | BYTE, WORD, DWORD, NEAR, FAR |
| 5 | + (unary), – (unary) |
| 6 | *, /, MOD |
| 7 | +, – |
| 8 | SHR, SHL |
| 9 | AND, OR, XOR |
| 10 | >=, <=, =, <>, <, >, GTE, LTE, EQ, NE, LT, GT |

3

Shaded directives and options are available only in AX51 and A251.

Expressions

An expression is a combination of operands and operators that must be calculated by the assembler. An operand with no operators is the simplest form of an expression. An expression can be used in most places where an operand is required.

Expressions have a number of attributes that are described in the following sections.

Expression Classes

Expressions are assigned classes based on the operands that are used. The following classes apply to expressions:

| Expression Class | Description |
|------------------|----------------------------------|
| N NUMB | A classless number. |
| C ADDR | A CODE address symbol. |
| D ADDR | A DATA address symbol. |
| I ADDR | An IDATA address symbol. |
| X ADDR | An XDATA address symbol. |
| B ADDR | A BIT address symbol. |
| CO ADDR | A CONST address symbol. |
| EC ADDR | An ECONST address symbol. |
| CE ADDR | An ECODE address symbol. |
| ED ADDR | An EDATA address symbol. |
| EB ADDR | An EBIT address symbol. |
| HD ADDR | An HDATA address symbol. |
| HC ADDR | An HCONST address symbol. |

Typically, expressions are assigned the class **NUMBER** because they are composed only of numeric operands. You may assign a class to an expression using a class operand. An address symbol value is automatically assigned the class of the segment where it is defined. When a value has a class, a few rules apply to how expressions are formed:

1. The result of a unary operation has the same class as its operand.
2. The result of all binary operations except + and – will be a **NUMBER** type.
3. If only one of the operands of an addition or subtraction operation has a class, the result will have that class. If both operands have a class, the result will be a **NUMBER**.

This means that a class value (i.e. an addresses symbol) plus or minus a number (or a number plus a class value) give a value with class.

Examples

```

data_address - 10           gives a data_address value
10 + edata_address        gives an edata_address value
(data_address - data_address) gives a classless number
code_address + (data_address - data_address) gives a code_address value

```

Expressions that have a type of **NUMBER** can be used virtually anywhere. Expressions that have a class can only be used where a class of that type is valid.

Relocatable Expressions

Relocatable expressions are so named because they contain a reference to a relocatable or external symbol. These types of expressions can only be partially calculated by the assembler since the assembler does not know the final location of relocatable segments. The final calculations are performed by the linker.

A relocatable expression normally contains only a relocatable symbol, however, it may contain other operands and operators as well. A relocatable symbol can be modified by adding or subtracting a constant value.

Examples for valid relocatable expression

- `relocatable_symbol + absolute_expression`
- `relocatable_symbol - absolute_expression`
- `absolute_expression + relocatable_symbol`

There are two basic types of relocatable expressions: simple relocatable expressions and extended relocatable expressions.

Simple Relocatable Expressions

Simple relocatable expressions contain symbols that are defined in a relocatable segment. Segment and external symbols are not allowed in simple relocatable expressions.

Simple relocatable expression can be used in four contexts:

1. As an operand to the ORG directive.
2. As an operand to a symbol definition directive (i.e. EQU, SET)
3. As an operand to a data initialization directive (DB, DW or **DD**)
4. As an operand to a machine instruction

Examples for simple relocatable expressions

```
REL1 + ABS1 * 10
REL2 - ABS1
REL1 + (REL2 - REL3)      assuming REL2 and REL3 refer to the same segment.
```

Invalid form of simple relocatable expressions

```
(REL1 + ABS1) * 10      relocatable value may not be multiplied.
(EXT1 - ABS1)           this is a general relocatable expression
REL1 + REL2             you cannot add relocatable symbols.
```

Shaded directives and options are available only in AX51 and A251.

Extended Relocatable Expressions

The extended relocatable expressions have generally the same rules that apply to simple relocatable expressions. Segment and external symbols are allowed in extended relocatable expressions. Extended relocatable expressions may be used only in statements that generate code as operands; these are:

- As an operand to a data initialization directive (DB, DW or **DD**)
- As an operand to a machine instruction

Examples for extended relocatable expressions

```
REL1 + ABS1 * 10
EXT1 - ABS1
LOW (REL1 + ABS1)
WORD2 (SEG1)
```

3

Invalid form of simple relocatable expressions

```
(SEG1 + ABS1) * 10          relocatable value may not be multiplied.
(EXT1 - REL1)               you can add/subtract only absolute quantities

LOW (REL1) + ABS1          LOW may be applied only to the
                           final relocatable expression
```

Examples with Expressions

```

EXTRN CODE (CLAB)          ; entry in CODE space
EXTRN DATA (DVAR)        ; variable in DATA space

MSK      EQU  0F0H          ; define a symbol to replace 0xF0
VALUE    EQU  MSK - 1      ; another constant symbolic value
LVAL     EQU  12345678H    ; LVAL get the value 12345678H

?PR?FOO SEGMENT CODE
RSEG ?PR?FOO

ENTRY:  MOV  A,#40H          ; load register with constant
        MOV  R5,#VALUE      ; load constant symbolic value
        MOV  R3,#(0x20 AND MASK) ; examples for calculations
        MOV  R7,#LOW (VALUE + 20H)
        MOV  R6,#1 OR (MSK SHL 4)

        MOV  R0,DVAR+20     ; load content from address DVAR+20
        MOV  R1,#LOW (CLAB+10) ; load low byte of address CLAB+10
        MOV  WR4,#WORD2 (LVAL) ; load high word of LVAL
        MOV  DR0,#ENTRY     ; load low word of addr. ENTRY to DR0
        MOVH DR0,#WORD2 (ENTRY) ; load high word of addr. ENTRY to DR0
        MOV  R4,@DR0       ; load content of ENTRY to R4
;
        MOV  R5,80H         ; load DATA addr. 80H (= SFR P0) to R5
        MOV  R5,EDATA 80H   ; load EDATA address 80H to R5
        SETB 30H.2         ; set bit at 30H.2 (long address)
        SETB 20H.2         ; set bit at 20H.2 (short address)

END

```

3

Shaded directives and options are available only in AX51 and A251.

Chapter 4. Assembler Directives

This chapter describes the assembler directives. It shows how to define symbols and how to control the placement of code and data in program memory.

Introduction

The **Ax51** assembler has several directives that permit you to define symbol values, reserve and initialize storage, and control the placement of your code.

The directives should not be confused with instructions. They do not produce executable code, and with the exception of the DB, DW and DD directives, they have no direct effect on the contents of code memory. These directives change the state of the assembler, define user symbols, and add information to the object file.

The following table provides an overview of the assembler directives. Page refers to the page number in this user's guide where you can find detailed information about the directive.

| Directive / Page | Format | Description |
|------------------|--|---|
| BIT 114 | <i>symbol</i> BIT <i>bit_address</i> | Define a bit address in bit data space. |
| BSEG 111 | BSEG [AT <i>absolute address</i>] | Define an absolute segment within the bit address space. |
| CODE 114 | <i>symbol</i> CODE <i>code_address</i> | Assign a symbol name to a specific address in the code space. |
| CSEG 111 | CSEG [AT <i>absolute address</i>] | Define an absolute segment within the code address space. |
| DATA 114 | <i>symbol</i> DATA <i>data_address</i> | Assign a symbol name to a specific on-chip data address. |
| DB 119 | [<i>label:</i>] DB <i>expression</i> [, <i>expr</i> ...] | Generate a list of byte values. |
| DBIT 122 | [<i>label:</i>] DBIT <i>expression</i> | Reserve a space in bit units. |
| DD 121 | [<i>label:</i>] DD <i>expression</i> [, <i>expr</i> ...] | Generate a list of double word values. |
| DS 123 | [<i>label:</i>] DS <i>expression</i> | Reserve space in byte units. |
| DSB 124 | [<i>label:</i>] DSB <i>expression</i> | Reserve space in byte units. |
| DSD 126 | [<i>label:</i>] DSD <i>expression</i> | Reserve space in double word units. |
| DSEG 111 | DSEG [AT <i>absolute address</i>] | Define an absolute segment within the indirect internal data space. |

Shaded directives and options are available only in AX51 and A251.

| Directive / Page | Format | Description |
|--|---|---|
| DSW 125 | <i>[label:] DSW expression</i> | Reserve space in word units; advances the location counter of the current segment. |
| DW 120 | <i>[label:] DW expression [, expr. ...]</i> | Generate a list of word values. |
| END 136 | END | Indicate end of program. |
| EQU 113 | <i>EQU expression</i> | Set symbol value permanently. |
| __ERROR__ 136 | <i>__ERROR__ text</i> | Generate a standard error message. |
| EVEN 134 | EVEN | Ensure word alignment for variables. |
| EXTRN 131 | <i>EXTRN class [:type] (symbol [, ...])</i> | Defines symbols referenced in the current module that are defined in other modules. |
| EXTERN | <i>EXTERN class [:type] (symbol [, ...])</i> | |
| IDATA 114 | <i>symbol IDATA idata_address</i> | Assign a symbol name to a specific indirect internal address. |
| ISEG 111 | <i>ISEG [AT absolute address]</i> | Define an absolute segment within the internal data space. |
| LABEL 129 | <i>name[:] LABEL [type]</i> | Assign a symbol name to a address location within a segment. |
| LIT 116 | <i>symbol LIT 'literal string'</i> | Assign a symbol name to a string. |
| NAME 132 | <i>NAME modulname</i> | Specify the name of the current module. |
| ORG 133 | <i>ORG expression</i> | Set the location counter of the current segment. |
| PROC 127 | <i>name PROC [type]</i> | Define a function start and end. |
| ENDP | <i>name ENDP</i> | |
| PUBLIC 130 | <i>PUBLIC symbol [, symbol ...]</i> | Identify symbols which can be used outside the current module. |
| RSEG 110 | <i>RSEG seg</i> | Select a relocatable segment. |
| SEGMENT 106 | <i>seg SEGMENT class [reloctype] [alloctype]</i> | Define a relocatable segment. |
| SET 113 | <i>SET expression</i> | Set symbol value temporarily. |
| sfr, sfr16 sbit 116 | <i>sfr symbol = address;</i> <i>sfr16 symbol = address;</i> <i>sbit symbol = address;</i> | Define a special function register (SFR) symbol or a SFR bit symbol. |
| USING 134 | <i>USING expression</i> | Set the predefined symbolic register address and reserve space for the specified register bank. |
| XDATA 114 | <i>symbol XDATA xdata_address</i> | Assign a symbol name to a specific off-chip data address. |
| XSEG 111 | <i>XSEG [AT absolute address]</i> | Define an absolute segment within the external data address space. |

Shaded directives and options are available only in AX51 and A251.

The directives are divided into the following categories:

- **Segment Control**
Generic Segments: **SEGMENT**, **RSEG**
Absolute Segments: **CSEG**, **DSEG**, **BSEG**, **ISEG**, **XSEG**
- **Symbol Definition**
Generic Symbols: **EQU**, **SET**
Address Symbols: **BIT**, **CODE**, **DATA**, **IDATA**, **XDATA**
SFR Symbols: **sfr**, **sfr16**, **sbit**
Text Replacement: **LIT**
- **Memory Initialization**
DB, **DW**, **DD**
- **Memory Reservation**
DBIT, **DS**, **DSB**, **DSW**, **DSD**
- **Procedure Declaration**
PROC / **ENDP**, **LABEL**
- **Program Linkage**
PUBLIC, **EXTRN** / **EXTERN**, **NAME**
- **Address Control**
ORG, **EVEN**, **USING**
- **Others**
END, **__ERROR__**

The **Ax51** assembler is a multi-pass assembler. In the first pass, symbol values are determined. In the subsequent passes, forward references are resolved and object code is produced. This structure imposes a restriction on the source program: expressions which define symbol values (refer to “Symbol Definition” on page 113) and expressions which control the location counter (refer to “ORG” on page 133, “DS” on page 123, and “DBIT” on page 122) may not have forward references.

Shaded directives and options are available only in AX51 and A251.

Segment Directives

A segment is a block of code or data memory the assembler creates from code or data in an **x51** assembly source file. How you use segments in your source modules depends on the complexity of your application. Smaller applications need less memory and are typically less complex than large multi-module applications.

The **x51** CPU has several specific memory areas. You use segments to locate program code, constant data, and variables in these areas.

Location Counter

Ax51 maintains a location counter for each segment. The location counter is a pointer to the address space of the active segment. It represents an offset for generic segments or the actual address for absolute segments. When a segment is first activated, the location counter is set to 0. The location counter is changed after each instruction by the length of the instruction. The memory initialization and reservation directives (i.e. DS, DB or DBIT) change the value of the location counter as memory is allocated by these directives. The ORG directive sets a new value for the location counter. If you change the active segment and later return to that segment, the location counter is restored to its previous value. Whenever the assembler encounters a label, it assigns the current value of the location counter and the type of the current segment to that label.

The dollar sign (\$) indicates the value of the location counter in the active segment. When you use the \$ symbol, keep in mind that its value changes with each instruction, but only after that instruction has been completely evaluated. If you use \$ in an operand to an instruction or directive, it represents the address of the first byte of that instruction.

The following sections describe the different types of segments.

Shaded directives and options are available only in AX51 and A251.

Generic Segments

Generic segments have a name and a class as well as other attributes. Generic segments with the same name but from different object modules are considered to be parts of the same segment and are called partial segments. These segments are combined at link time by the linker/locator.

Generic segments are created using the **SEGMENT** directive. You must specify the name of the segment, the segment class, and an optional relocation type and alignment type when you create a relocatable segment.

Example

```
MYPROG SEGMENT CODE
```

defines a segment named **MYPROG** with a memory class of **CODE**. This means that data in the **MYPROG** segment will be located in the code or program area of the **x51**. Refer to “SEGMENT” on page 106 for more information on how to declare generic segments.

Once you have defined a relocatable segment name, you must select that segment using the **RSEG** directive. When **RSEG** is used to select a segment, that segment becomes the active segment that **Ax51** uses for subsequent code and data until the segment is changed with **RSEG** or with an absolute segment directive.

Example

```
RSEG MYPROG
```

will select the **MYPROG** segment that is defined above.

Typically, assembly routines are placed in generic segments. If you interface your assembly routines to C, all of your assembly routines must reside in separate generic segments and the segment names must follow the standards used by **Cx51**. Refer to the *Compiler User's Guide* for more information on interfacing assembler programs to C.

Stack Segment

The **x51** architecture uses a hardware stack to store return addresses for **CALL** instructions and also for temporary storage using the **PUSH** and **POP** instructions. An 8051 application that uses these instructions must setup the stack pointer to an area of memory that will not be used by other variables.

For the classic **8051** a stack segment must be defined and space must be reserved as follows. This definition also works for the extended 8051 and the 251, however these controllers typically support stack also in other areas.

```
STACK          SEGMENT  IDATA
               RSEG     STACK      ; select the stack segment
               DS       10h        ; reserve 16 bytes of space
```

Then, you must initialize the stack pointer early in your program.

```
CSEG          AT      0          ; RESET Vector
              JMP     STARTUP    ; Jump to startup code
STARTUP:
              MOV     SP,#STACK - 1 ; load Stack Pointer
```

For the Philips 80C51MX or the Intel/Atmel WM 251 a stack segment may be defined and space must be reserved as follows.

```
STACK          SEGMENT  EDATA
               RSEG     STACK      ; select the stack segment
               DS       100h       ; reserve 256 bytes of space
```

Then, you must initialize the stack pointer early in your program.

```
CSEG          AT      0          ; RESET Vector
              JMP     STARTUP    ; Jump to startup code
STARTUP:
              ; code executed at RESET
; Stack setup for Philips 80C51MX
              ORL     MXCON,#0x02 ; enable extended stack
              MOV     SPE,#HIGH (STACK - 1) ; load Stack high
              MOV     SP,#LOW (STACK - 1) ; load Stack low

; for Intel/Atmel WM 251
              MOV     DR60,#STACK - 1 ; load Stack Pointer
```

If you are interfacing assembly routines to C, you probably do not need to setup the stack. This is already done for you in the C startup code.

Shaded directives and options are available only in AX51 and A251.

Absolute Segments

Absolute segments reside in a fixed memory location. Absolute segments are created using the **CSEG**, **DSEG**, **XSEG**, **ISEG**, and **BSEG** directives. These directives allow you to locate code and data or reserve memory space in a fixed location. You use absolute segments when you need to access a fixed memory location or when you want to place program code or constant data at a fixed memory address. Refer to the **CSEG**, **DSEG**, **ISEG**, **XSEG**, **ISEG** directives for more information on how to declare absolute segments.

After reset, the 8051 variants begin program executing at CODE address 0. The Intel/Atmel WM 251 starts execution at address FF0000. Some type of program code must reside at this address. You can use an absolute segment to force program code into this address. The following example is used in the **Cx51** startup routines to branch from the reset address to the beginning of the initialization code.

```

.
.
.
.
RESET_VEC:      CSEG      AT 0
                 LJMPL    STARTUP
.
.
.

```

The program code that we place at address 0000h (for 251 at address FF0000h) with the **CSEG AT 0** directive performs a jump to the **STARTUP** label.

AX51 and **A251** supports absolute segment controls for compatibility to **A51**. **AX51** and **A251** translates the **CSEG**, **DSEG**, **XSEG**, **ISEG** and **BSEG** directives to a generic segment directive.

Default Segment

By default, **Ax51** assumes that the CODE segment is selected and initializes the location counter to 0000h (FF0000h) when it begins processing an assembly source module. This allows you to create programs without specifying any relocatable or absolute segment directives.

Shaded directives and options are available only in AX51 and A251.

SEGMENT

The **SEGMENT** directive is used to declare a generic segment. A relocation type and an allocation type may be specified in the segment declaration. The **SEGMENT** directive is specified using the following format:

```
segment SEGMENT class reloctype alloctype
```

where

| | |
|------------------|---|
| <i>segment</i> | is the symbol name to assign to the segment. This symbol name is referred by the following RSEG directive. The segment symbol name can be used also in expressions to represent the base or start address of the combined segment as calculated by the Linker/Locator. |
| <i>class</i> | is the memory class to use for the specified segment. The class specifies the memory space for the segment. See the table below for more information. |
| <i>reloctype</i> | is the relocation type for the segment. This determines what relocation options may be performed by the Linker/Locator. Refer to the table below for more information. |
| <i>alloctype</i> | is the allocation type for the segment. This determines what relocation options may be performed by the Linker/Locator. Refer to the table below for more information. |

Class

The name of each segment within a module must be unique. However, the linker will combine segments having the same segment type. This applies to segments declared in other source modules as well.

The `class` specifies the memory class space for the segment. The A251 differentiates between basic classes and user-defined classes. The `class` is used by the linker/locator to access all the segments which belong to that class.

The basic classes are listed below:

| Basic Class | Description |
|---------------|---|
| BIT | BIT space (address 20H .. 2FH). |
| CODE | CODE space |
| CONST | CONST space; same as CODE but for constant only; access via MOVC. |
| DATA | DATA space (address 0 to 7FH & SFR registers). |
| EBIT | Extended 251 bit space (address 20H .. 7FH) |
| EDATA | EDATA space |
| ECONST | ECONST space; same as EDATA but for constants |
| IDATA | IDATA space (address 0 to 0FFH). |
| ECODE | Entire Intel/Atmel WM 251 and Philips 80C51MX address space for program code. |
| HCONST | Entire Intel/Atmel WM 251 and Philips 80C51MX address space for constants. |
| HDATA | Entire Intel/Atmel WM 251 and Philips 80C51MX address space for data. |
| XDATA | XDATA space; access via MOVX. |

4

User-defined Class Names (AX51 & A251 only)

User-defined class names are composed of a basic class name and an extension and are enclosed in single quotes ('). They let you access the same address space as basic class names. The advantage is that you may declare several segments with a user-defined class and later use the linker to locate that class (and its segments) at a specific physical address. Refer to the “CLASSES” on page 336 for information on how to locate user defined classes.

Examples

```
seg1    SEGMENT    'NDATA_FLASH'
seg2    SEGMENT    'HCONST_BITIMAGE'
seg3    SEGMENT    'DATA1'
```

Shaded directives and options are available only in AX51 and A251.

Relocation Type

The optional relocation type defines the relocation operation that may be performed by the Linker/Locator. The following table lists the valid relocation types:

| Relocation Type | Description |
|---------------------------|---|
| AT <i>address</i> | Specifies an absolute segment. The segment will be placed at the specified <i>address</i> . |
| BITADDRESSABLE | Specifies a segment which will be located within the bit addressable memory area (20H to 2FH in DATA space). BITADDRESSABLE is only allowed for segments with the class DATA that do not exceed 16 bytes in length. |
| INBLOCK | Specifies a segment which must be contained in a 2048Byte block. This relocation type is only valid for segments with the class CODE . |
| INPAGE | Specifies a segment which must be contained in a 256Byte page. |
| OFFS <i>offset</i> | Specifies an absolute segment. The segment is placed at the starting address of the memory class plus the specified <i>offset</i> . The advantage compared to the AT relocation type is that the start address can be modified with the Lx51 linker/locator control CLASSES. Refer to the "CLASSES" on page 336 for more information. |
| OVERLAYABLE | Specifies that the segment can share memory with other segments. Segments declared with this relocation type can be overlaid with other segments which are also declared with the OVERLAYABLE relocation type. When using this relocation type, the segment name must be declared according to the C251, CX51, C51 or PL/M-51 segment naming rules. Refer to the <i>C Compiler User's Guide</i> for more information. |
| INSEG | Specifies a segment which must be contained in a 64KByte segment. |

4

Shaded directives and options are available only in AX51 and A251.

Allocation Type

The optional allocation type defines the allocation operation that may be performed by the Linker/Locator. The following table lists the valid allocation types:

| Allocation Type | Description |
|-----------------|---|
| BIT | Specify bit alignment for the segment. Default for all segments with the class BIT. |
| BYTE | Specify byte alignment for the segment. Default for all segments except of BIT. |
| WORD | Specify word alignment for the segment. |
| DWORD | Specify dword alignment for the segment. |
| PAGE | Specify a segment whose starting address must be on a 256Byte page boundary. |
| BLOCK | Specify a segment whose starting address must be on a 2048Byte block boundary. |
| SEG | Specify a segment whose starting address must be on a 64KByte segment boundary. |

Examples for Segment Declarations

```
IDS      SEGMENT      IDATA
```

Defines a segment with the name IDS and the memory class IDATA.

```
MYSEG   SEGMENT      CODE      AT 0FF2000H
```

Defines a segment with the name MYSEG and the memory class CODE to be located at address 0FF2000H.

```
HDSEG   SEGMENT      HDATA INSEG DWORD
```

Defines a segment with the name HDSEG and the memory class HDATA. The segment is located within one 64KByte segment and is DWORD aligned.

```
XDSEG   SEGMENT      XDATA PAGE
```

Defines a segment with the name XDSEG and the memory class XDATA. The segment is PAGE aligned, this means it starts on a 256Byte page.

Shaded directives and options are available only in AX51 and A251.

```
HCSEG      SEGMENT      HCONST SEG
```

Defines a segment with the name HCSEG with the memory class HCONST. The segment is SEGMENT aligned, this means it starts on a 64KByte segment.

RSEG

The RSEG directive selects a generic segment that was previously declared using the SEGMENT directive. The RSEG directive uses the following format:

```
RSEG segment
```

where

segment is the name of a segment that was previously defined using the SEGMENT directive. Once selected, the specified segment remains active until a new segment is specified.

Example

```
.
.
.
MYPROG          SEGMENT      CODE          ; declare a segment

                RSEG        MYPROG        ; select the segment
                MOV         A, #0
                MOV         P0, A

.
.
.
```

BSEG, CSEG, DSEG, ISEG, XSEG

The **BSEG**, **CSEG**, **DSEG**, **ISEG**, **XSEG** directives select an absolute segment. This directives use the following formats:

| | | | |
|-------------|-----------|----------------|------------------------------------|
| BSEG | AT | <i>address</i> | defines an absolute BIT segment. |
| CSEG | AT | <i>address</i> | defines an absolute CODE segment. |
| DSEG | AT | <i>address</i> | defines an absolute DATA segment. |
| ISEG | AT | <i>address</i> | defines an absolute IDATA segment. |
| XSEG | AT | <i>address</i> | defines an absolute XDATA segment. |

where

address is an optional absolute base address at which the segment begins. The *address* may not contain any forward references and must be an expression that can be evaluated to a valid address.

CSEG, **DSEG**, **ISEG**, **BSEG** and **XSEG** select an absolute segment within the code, internal data, indirect internal data, bit, or external data address spaces. If you choose to specify an absolute address (by including **AT** *address*), the assembler terminates the last absolute segment, if any, of the specified segment type, and creates a new absolute segment starting at that address. If you do not specify an address, the last absolute segment of the specified type is continued. If no absolute segment of this type was selected and the absolute address is omitted, a new segment is created starting at location 0. You cannot use any forward references and the start address must be an absolute expression.

The **AX51** and **A251** Macro Assembler supports the **BSEG**, **CSEG**, **DSEG**, **ISEG**, and **XSEG** directives for **A51** compatibility.

These directives are converted to standard segments as follows:

| A51 Directive | Converted to AX51/A251 Segment Declaration |
|---------------|--|
| BSEG AT 20H.1 | ?BI?modulename?n SEGMENT OFFS 20H.1 |
| CSEG AT 1234H | ?CO?modulename?n SEGMENT OFFS 1234H |
| DSEG AT 40H | ?DT?modulename?n SEGMENT OFFS 40H |
| ISEG AT 80H | ?ID?modulename?n SEGMENT OFFS 80H |
| XSEG AT 5100H | ?XD?modulename?n SEGMENT OFFS 5100H |

where

modulname is the name of the current assembler module

n is a sequential number incremented for every absolute segment.

Examples

```

BSEG AT 30h          ; absolute bit segment @ 30h
DEC_FLAG:           DBIT 1          ; absolute bit
INC_FLAG:           DBIT 1
CSEG AT 100h        ; absolute code segment @ 100h
PARITY_TAB:        DB 00h          ; parity for 00h
                   DB 01h          ;          01h
                   DB 01h          ;          02h
                   DB 00h          ;          03h
.
.
.
                   DB 01h          ;          FEh
                   DB 00h          ;          FFh
DSEG AT 40h         ; absolute data segment @ 40h
TMP_A:             DS 2            ; absolute data word
TMP_B:             DS 4
ISEG AT 40h         ; abs indirect data seg @ 40h
TMP_IA:           DS 2
TMP_IB:           DS 4
XSEG AT 1000h       ; abs external data seg @ 1000h
OEMNAME:          DS 25           ; abs external data
PRDNAME:          DS 25
VERSION:          DS 25

```

Shaded directives and options are available only in AX51 and A251.

Symbol Definition

The symbol definition directives allow you to create symbols that can be used to represent registers, numbers, and addresses.

Symbols defined by these directives may not have been previously defined and may not be redefined by any means. The **SET** directive is the only exception to this.

EQU, SET

The **EQU** and **SET** directive assigns a numeric value or register symbol to the specified symbol name. Symbols defined with **EQU** may not have been previously defined and may not be redefined by any means. The **SET** directive allows later redefinition of symbols. Statements involving the **EQU** or **SET** directive are formatted as follows:

| | | |
|---------------|------------|-------------------|
| <i>symbol</i> | EQU | <i>expression</i> |
| <i>symbol</i> | EQU | <i>register</i> |
| <i>symbol</i> | SET | <i>expression</i> |
| <i>symbol</i> | SET | <i>register</i> |

where

symbol is the name of the symbol to define. The expression or register specified in the **EQU** or **SET** directive will be substituted for each occurrence of *symbol* that is used in your assembly program.

expression is a numeric expression which contains no forward references, or a simple relocatable expression.

register is one of the following register names: A, R0, R1, R2, R3, R4, R5, R6, or R7.

Symbols defined with the **EQU** or **SET** directive may be used anywhere in operands, expressions, or addresses. Symbols that are defined as a register name can be used anywhere a register is allowed. A251 replaces each occurrence of the defined symbol in your assembly program with the specified numeric value or register symbol.

Shaded directives and options are available only in AX51 and A251.

Symbols defined with the **EQU** directive may not be changed or redefined. You cannot use the **SET** directive if a symbol was previously defined with **EQU** and you cannot use the **EQU** directive if a symbol which was defined with **SET**.

Examples

```
LIMIT      EQU      1200
VALUE     EQU      LIMIT - 200 + 'A'
SERIAL    EQU      SBUF
ACCU      EQU      A
COUNT   EQU      R5
VALUE     SET      100
VALUE     SET      VALUE / 2
COUNTER   SET      R1
TEMP      SET      COUNTER
TEMP      SET      VALUE * VALUE
```

CODE, DATA, IDATA, XDATA

The **BIT**, **CODE**, **DATA**, **IDATA**, and **XDATA** directives assigns an address value to the specified symbol. Symbols defined with the **BIT**, **CODE**, **DATA**, **IDATA**, and **XDATA** directives may not be changed or redefined. The format of these directives is:

| | | | |
|---------------|--------------|----------------------|--------------------------------|
| <i>symbol</i> | BIT | <i>bit_address</i> | defines a BIT symbol |
| <i>symbol</i> | CODE | <i>code_address</i> | defines a CODE symbol |
| <i>symbol</i> | DATA | <i>data_address</i> | defines a DATA symbol |
| <i>symbol</i> | IDATA | <i>idata_address</i> | defines an IDATA symbol |
| <i>symbol</i> | XDATA | <i>xdata_address</i> | defines a XDATA symbol |

where

symbol is the name of the symbol to define. The symbol name can be used anywhere an address of this memory class is valid.

bit_address is the address of a bit in internal data memory in the area 20H .. 2FH or a bit address of an 8051 bit-addressable SFR.

code_address is a code address in the range 0000H .. 0FFFFH.

data_address is a data memory address in the range 0 to 127 or a special function register (SFR) address in the range 128 .. 255.

idata_address is an idata memory address in the range 0 to 255.

xdata_address is an xdata memory address in the range 0 to 65535.

Shaded directives and options are available only in AX51 and A251.

Example

```

DATA_SEG      SEGMENT BITADDRESSABLE
RSEG          DATA_SEG          ; a bit-addressable rel_seg

CTRL:        DS      1          ; a 1-byte variable (CTRL)
ALARM        BIT     CTRL.0     ; bit in a relocatable byte
SHUT         BIT     ALARM+1    ; the next bit
ENABLE_FLAG  BIT     60H        ; an absolute bit
DONE_FLAG    BIT     24H.2      ; an absolute bit
P1_BIT2      EQU     90H.2      ; a SFR bit
RESTART      CODE    00H
INTVEC_0     CODE    RESTART + 3
INTVEC_1     CODE    RESTART + 0BH
INTVEC_2     CODE    RESTART + 1BH
SERBUF       DATA    SBUF      ; redefinition of SBUF
RESULT       DATA    40H
RESULT2      DATA    RESULT + 2
PORT1        DATA    90H      ; a SFR symbol
BUFFER       IDATA    60H
BUF_LEN      EQU     20H
BUF_END      IDATA    BUFFER + BUF_LEN - 1
XSEG1        SEGMENT XDATA
RSEG         XSEG1

DTIM:        DS      6          ;reserve 6-bytes for DTIM
TIME         XDATA    DTIM + 0
DATE         XDATA    DTIM + 3

```

esfr, sfr, sfr16, sbit

The **sfr**, **sfr16** and **sbit** directives are fully compatible to the **Cx51** compiler and allows you to use a generic SFR register definition file for both: the **Ax51** macro assembler and the **Cx51** compiler. The **esfr** directive defines symbols in the extended SFR space of the Philips 80C51MX architecture. This directive is only available in the AX51 macro assembler. These directives have the following format:

```
sfr   sfr_symbol = address;
esfr  sfr_symbol = address;
sfr16 sfr_symbol = address;           ; ignored by Ax51
sbit  sfr_symbol = bit-address;
```

where

sfr_symbol is the name of the special function register (SFR) symbol to define.

address is an SFR address in the range 0x80 – 0xFF.

bit-address is address of an SFR bit in the format *address* ^ *bitpos* or *sfr_symbol* ^ *bitpos*. *address* or *sfr_symbol* refers to an bit-addressable SFR and *bitpos* specifies the bit position of the SFR bit in the range 0 – 7.

Symbols defined with the **esfr**, **sfr**, or **sbit** directive may be used anywhere as address of a SFR or SFR bit.

Example

```
sfr   P0    = 0x80;
sfr   P1    = 0x90;
sbit  P0_0  = P0^0;
sbit  P1_1  = 0x90^1;
esfr  MXCON = 0xFF;      /* extended Philips 80C51MX SFR */
sfr16 T2    = 0xCC;      /* ignored by Ax51 */
```

NOTE

The **Ax51** assembler ignores symbol definitions that start with **sfr16**. This is implemented for compatibility to the **Cx51** compiler.

Shaded directives and options are available only in AX51 and A251.

LIT (AX51 & A251 only)

The **LIT** directive provides a simple text substitution facility. The **LIT** directive has the following format:

```
symbol      LIT      'literal string'
symbol      LIT      "literal string"
```

where

symbol is the name of the symbol to define. The literal string specified in the **LIT** directive will be substituted for each occurrence of *symbol* that is used in your assembly program.

literal string is a numeric expression which contains no forward references, or a simple relocatable expression.

Every time the *symbol* is encountered, it is replaced by the *literal string* assigned to the symbol name. The symbol name follows the same rules as other identifiers, that is, a literal name is not encountered if it does not form a separate token. If a substring is to be replaced, *symbol* must be enclosed in braces: TEXT{*symbol*}. The assembler listing shows the expanded lines where literals are substituted.

Example

Source text containing literals before assembly:

```

$INCLUDE (REG51.INC)

REG1      LIT      'R1'
NUM       LIT      'A1'
DBYTE    LIT      "DATA BYTE"
FLAG     LIT      'ACC.3'

?PR?MOD  SEGMENT  CODE
          RSEG    ?PR?MOD

          MOV     REG1, #5
          SETB   FLAG
          JB     FLAG, LAB_{NUM}
          PUSH   DBYTE 0
LAB_{NUM}:

          END
```

Assembler listing from previous example:

```

      1      $INCLUDE (REG51.INC)
+1    80    +1 $RESTORE
      81
      82      REG1      LIT      'R1'
      83      NUM       LIT      'A1'
      84      DBYTE     LIT      "DATA BYTE"
      85      FLAG      LIT      'ACC.3'
      86
-----      87      ?PR?MOD SEGMENT CODE
-----      88      RSEG ?PR?MOD
      89
000000 7E1005      90      MOV      R1,#5
000003 D2E3      91      SETB     ACC.3
000005 20E300      F      92      JB      ACC.3,LAB_A1
000008 C000      93      PUSH     DATA BYTE 0
00000A      94      LAB_A1:
      95
      96      END
```

4

Memory Initialization

The memory initialization directives are used to initialize code or constant space in either word, double-word, or byte units. The memory image starts at the point indicated by the current value of the location counter in the currently active segment.

DB

The **DB** directive initializes code memory with 8-bit byte values. The **DB** directive has the following format:

```
label: DB expression , expression ...
```

where

label is the symbol that is given the address of the initialized memory.

expression is a byte value. Each *expression* may be a symbol, a character string, or an expression.

The **DB** directive can only be specified within a code or const segment. If the **DB** directive is used in a different segment, **Ax51** will generate an error message.

Example

```
REQUEST: DB 'PRESS ANY KEY TO CONTINUE', 0
TABLE:   DB 0,1,8,'A','0', LOW(TABLE),';'
ZERO:    DB 0, ' '
CASE_TAB: DB LOW(REQUEST), LOW(TABLE), LOW(ZERO)
```

DW

The **DW** directive initializes code memory with 16-bit word values. The **DW** directive has the following format:

```
label: DW expression , expression ...
```

where

label is the symbol that is given the address of the initialized memory.

expression is the initialization data. Each *expression* may contain a symbol, a character string, or an expression.

The **DW** directive can only be specified within a code or const segment. If the **DW** directive is used in a different segment, **Ax51** will generate an error message.

Example

```
TABLE: DW TABLE, TABLE + 10, ZERO
ZERO: DW 0
CASE_TAB: DW CASE0, CASE1, CASE2, CASE3, CASE4
DW $
```

DD (AX51 & A251 only)

The **DD** directive initializes code memory with 32-bit double word values. The **DD** directive has the following format:

```
label: DD expression , expression ...
```

where

label is the symbol that is given the address of the initialized memory and

expression is the initialization data. Each *expression* may contain a symbol, a character string, or an expression.

The **DD** directive can only be specified within a code or const segment. If the **DD** directive is used in a different segment, **Ax51** will generate an error message.

Example

```
TABLE:    DD    TABLE, TABLE + 10, ZERO
          DD    $
ZERO:     DD    0
LONG_VAL: DD    12345678H, 0FFFFFFFH, 1
```

Reserving Memory

The memory reservation directives are used to reserve space in either word, dword, byte, or bit units. The space reserved starts at the point indicated by the current value of the location counter in the currently active segment.

DBIT

The **DBIT** directive reserves space in a bit or ebit segment. The **DBIT** directive has the following format:

```
label:  DBIT  expression
```

where

label is the symbol that is given the address of the reserved memory. The label is a symbol of the type BIT and gets the current address value and the memory class of the active segment. The label can only be used where a symbol of this type is allowed.

expression is the number of bits to reserve. The **expression** cannot contain forward references, relocatable symbols, or external symbols.

The **DBIT** directive reserves space in the bit segment starting at the current address. The location counter for the bit segment is increased by the value of the **expression**. You should note that the location counter for the bit segment references bits and not bytes.

NOTE

*The Ax51 assembler is a two-pass assembler. Symbols are collected and the length of each instruction is determined in the first pass. In the second pass, forward references are resolved and object code is produced. For these reasons, an expression used with the **DBIT** directive may not contain forward references.*

Example

```
ON_FLAG:  DBIT  1      ; reserve 1 bit
OFF_FLAG: DBIT  1
```

Shaded directives and options are available only in AX51 and A251.

DS

The **DS** directive reserves a specified number of bytes in a memory space. The **DS** directive has the following format:

```
label: DS expression
```

where

label is the symbol that is given the address of the reserved memory. The label is a typeless number and gets the current address value and the memory class of the active segment. The label can only be used where a symbol of this type is allowed.

expression is the number of bytes to reserve. The **expression** cannot contain forward references, relocatable symbols, or external symbols.

The **DS** directive reserves space in the current segment at the current address. The current address is then increased by the value of the **expression**. The sum of the location counter and the value of the specified **expression** should not exceed the limitations of the current address space.

NOTE

*The A251 assembler is a two-pass assembler. Symbols are collected and the length of each instruction is determined in the first pass. In the second pass, forward references are resolved and object code is produced. For these reasons, an expression used with the **DS** directive may not contain forward references.*

Example

```
GAP: DS (($ + 16) AND 0FFF0H) - $
      DS 20
TIME: DS 8
```

DSB (AX51 & A251 only)

The **DSB** directive reserves a specified number of bytes in a memory space. The **DSB** directive has the following format:

```
label: DSB expression
```

where

label is the symbol that is given the address of the reserved memory. The label is a symbol of the type BYTE and gets the current address value and the memory class of the active segment. The label can only be used where a symbol of this type is allowed.

expression is the number of bytes to reserve. The **expression** cannot contain forward references, relocatable symbols, or external symbols.

4

The **DSB** directive reserves space in the current segment at the current address. The current address is then increased by the value of the **expression**. The sum of the location counter and the value of the specified **expression** should not exceed the limitations of the current address space.

NOTE

*The Ax51 assembler is a two-pass assembler. Symbols are collected and the length of each instruction is determined in the first pass. In the second pass, forward references are resolved and object code is produced. For these reasons, an expression used with the **DSB** directive may not contain forward references.*

Example

```
DAY:      DSB    1
MONTH:    DSB    1
HOUR:     DSB    1
MIN:      DSB    1
```

Shaded directives and options are available only in AX51 and A251.

DSW (AX51 & A251 only)

The **DSW** directive reserves a specified number of words in a memory space. The **DSW** directive has the following format:

```
label: DSW expression
```

where

label is the symbol that is given the address of the reserved memory. The label is a symbol of the type WORD and gets the current address value and the memory class of the active segment. The label can only be used where a symbol of this type is allowed.

expression is the number of bytes to reserve. The **expression** cannot contain forward references, relocatable symbols, or external symbols.

The **DSW** directive reserves space in the current segment at the current address. The current address is then increased by the value of the *expression*. The sum of the location counter and the value of the specified *expression* should not exceed the limitations of the current address space.

NOTE

*The Ax51 assembler is a two-pass assembler. Symbols are collected and the length of each instruction is determined in the first pass. In the second pass, forward references are resolved and object code is produced. For these reasons, an expression used with the **DSW** directive may not contain forward references.*

Example

```
YEAR: DSW 1  
DAYinYEAR: DSW 1
```

Shaded directives and options are available only in AX51 and A251.

DSD (AX51 & A251 only)

The **DSD** directive reserves a specified number of double words in a memory space. The **DSD** directive has the following format:

```
label: DSD expression
```

where

label is the symbol that is given the address of the reserved memory. The label is a symbol of the type DWORD and gets the current address value and the memory class of the active segment. The label can only be used where a symbol of this type is allowed.

expression is the number of bytes to reserve. The **expression** cannot contain forward references, relocatable symbols, or external symbols.

4

The **DSD** directive reserves space in the current segment at the current address. The current address is then increased by the value of the **expression**. The sum of the location counter and the value of the specified **expression** should not exceed the limitations of the current address space.

NOTE

*The Ax51 assembler is a two-pass assembler. Symbols are collected and the length of each instruction is determined in the first pass. In the second pass, forward references are resolved and object code is produced. For these reasons, an expression used with the **DSD** directive may not contain forward references.*

Example

```
SEC_CNT:    DSD    1
LONG_ARR:   DSD   50
```

Shaded directives and options are available only in AX51 and A251.

Procedure Declaration (AX51 & A251 only)

Ax51 provides procedures to implement the concept of subroutines. Procedures can be executed in-line (control “falls through” to them), jumped to, or invoked by a CALL. Calls are recommended as a better programming practice.

PROC / ENDP (AX51 & A251 only)

The PROC and ENDP directives are used to define a label for a sequence of machine instructions called a procedure. For the Philips 80C51MX and Intel/Atmel WM 251 architecture a procedure may have either the type NEAR or FAR. Depending on the type it is called with LCALL or ACALL (for NEAR) or ECALL (for FAR). Unlike C functions, assembler procedures do not provide local scopes for labels. Identifiers must be unique in A251 because the visibility is module wide. The format of the PROC/ENDP directives is:

```

name      PROC    [ type ]
           ; procedure text
:
:
name      RET
name      ENDP

```

where

name is the name of the procedure.

type specifies the type of the procedure, and must be one of the following:

| Type | Description |
|-------------|--|
| none | The type defaults to NEAR |
| NEAR | Defines a near procedure; called with LCALL or ACALL. |
| FAR | Defines a far procedure; called with ECALL. |

You should specify FAR if the procedure is called from a different 64KByte segment. A procedure normally ends with a RET instruction. The software instruction RET will automatically be converted to an appropriate machine return instruction. For example:

RET Return from a near procedure.

ERET Return from a far procedure.

Example

```
P100            PROC    NEAR
               RET
               ENDP                    ; near return

P200            PROC    FAR
               RET
               ENDP                    ; far return (ERET)

P300            PROC    NEAR
               CALL    P100            ; LCALL
               CALL    P200            ; ECALL
               RET
               ENDP                    ; near return

               END
```

4

LABEL (AX51 and A251 only)

A label is a symbol name for an address location in a segment. The LABEL directive can be used to define a program label. The label name can be followed by a colon, but it is not required. The label inherits the attributes of the program or code segment currently active. The LABEL directive may therefore never be used outside the scope of a program segment. The syntax of that directive is:

```
name[:] LABEL [ type ]
```

where

name is the name of the label.

type specifies the type of the label, and must be one of the following:

| Type | Description |
|-------------|--|
| none | The type defaults to NEAR |
| NEAR | Defines a near label. |
| FAR | Defines a far label; use ECALL or EJMP. |

You should specify FAR if the label will be referenced from a different 64KByte segment. NEAR lets you refer to this label for the current 64KByte segment.

Example

```
ENTRY: RSEG ECODE_SEG1 ; activate an ECODE segment
        LABEL FAR ; entry point

        RSEG ECODE_SEG2 ; activate another ECODE segment
        EJMP ENRTY ; Jump across 64KB segment
```

Program Linkage

Program linkage directives allow the separately assembled modules to communicate by permitting inter-module references and the naming of modules.

PUBLIC

The **PUBLIC** directive lists symbols that may be used in other object modules. The **PUBLIC** directive makes the specified symbols available in the generated object module. This, in effect, publicizes the names of these symbols. The **PUBLIC** directive has the following format:

```
PUBLIC symbol , symbol ...
```

where

symbol must be a symbol that was defined somewhere within the source file. Forward references to symbol names are permitted. All symbol names, with the exception of register symbols and segment symbols, may be specified with the **PUBLIC** directive. Multiple symbols must be separated with a comma (,).

If you want to use public symbols in other source files, the **EXTRN** or **EXTERN** directive must be used to specify that the symbols are declared in another object module.

Example

```
PUBLIC PUT_CRLF, PUT_STRING, PUT_EOS
PUBLIC ASCBIN, BINASC
PUBLIC GETTOKEN, GETNUMBER
```

Shaded directives and options are available only in AX51 and A251.

EXTRN / EXTERN

The **EXTRN** and **EXTERN** directives list symbols (referenced by the source module) that are actually declared in other modules. The format for the **EXTRN** and **EXTERN** directives is as follows:

```
EXTRN  class : type (symbol , symbol ... )
EXTERN class : type (symbol , symbol ... )
```

where

class is the memory class where the symbol has been defined and may be one of the following: **BIT**, **CODE**, **CONST**, **DATA**, **EBIT**, **ECONST**, **EDATA**, **ECODE**, **HDATA**, **HCONST**, **IDATA**, **XDATA**, or **NUMBER** (to specify a typeless symbol).

type is the symbol type of the external symbol and may be one of the following: **BYTE**, **WORD**, **DWORD**, **NEAR**, **FAR**.

symbol is an external symbol name.

The **EXTRN** or **EXTERN** directive may appear anywhere in the source program. Multiple symbols may be separated and included in parentheses following the class and type information.

Symbol names that are specified with the **EXTRN** / **EXTERN** directive must have been specified as public symbols with the **PUBLIC** directive in the source file in which they were declared.

The Linker/Locator resolves all external symbols at link time and verifies that the symbol class and symbol types (specified with the **EXTRN** / **EXTERN** and **PUBLIC** directives) match. Symbols with the class **NUMBER** match every memory class.

Examples

```
EXTRN  CODE (PUT_CRLF), DATA (BUFFER)
EXTERN CODE (BINASC, ASCBIN)
EXTERN NUMBER (TABLE_SIZE)
EXTERN CODE:FAR (main)
EXTRN  EDATA:BYTE (VALUE, COUNT)
EXTRN  NCONST:DWORD (LIMIT)
```

Shaded directives and options are available only in AX51 and A251.

NAME

The **NAME** directive specifies the name to use for the object module generated for the current program. The filename for the object file is not the object module name. The object module name is embedded within the object file. The format for the **NAME** directive is as follows:

```
NAME modulename
```

where

modulename is the name to use for the object module and can be up to 40 characters long. The *modulename* must adhere to the rules for symbol names.

If a **NAME** directive is not present in the source program, the object module name will be the *basename* of the source file without the extension.

NOTE

Only one NAME directive may be specified in a source file.

Example

```
NAME PARSEMODULE
```

4

Address Control

The following directives allow the control of the address location counter or the control of absolute register symbols.

ORG

The **ORG** directive is used to alter the location counter of the currently active segment and sets a new origin for subsequent statements. The format for the **ORG** statement is as follows:

```
ORG expression
```

where

expression must be an absolute or simple relocatable expression without any forward references. Only absolute addresses or symbol values in the current segment may be used.

When an **ORG** statement is encountered, the assembler calculates the value of the *expression* and changes the location counter for the current segment. If the **ORG** statement occurs in an absolute segment, the location counter is assigned the absolute address value. If the **ORG** statement occurs in a relocatable segment, the location counter is assigned the offset of the specified *expression*.

The **ORG** directive changes the location counter but does not produce a new segment. A possible address gap may be introduced in the segment. With absolute segments, the location counter may not reference an address prior to the base address of the segment.

NOTE

*The Ax51 assembler is a multi-pass assembler. Symbols are collected and the length of each instruction is determined in the first pass. In the second pass, forward references are resolved and object code is produced. For these reasons, an expression used with the **ORG** directive may not contain forward references.*

Example

```
ORG 100H  
ORG RESTART
```

Shaded directives and options are available only in AX51 and A251.

```
ORG     EXTI1
ORG     ($ + 16) AND 0FFF0H
```

EVEN (AX51 and A251 only)

The **EVEN** directive ensures that code or data following **EVEN** is aligned on a word boundary. The assembler creates a gap of one byte if necessary. The content of the byte gap is undefined. The **EVEN** directive has the following syntax:

```
EVEN
```

Example

```
MYDATA SEGMENT DATA WORD ; word alignment
        RSEG MYDATA ; activate segment
var1:   DSB 1 ; reserve a byte variable
        EVEN ; ensure word alignment
var2:   DSW 1 ; reserve a word variable
```

4

USING

The **USING** directive specifies which register bank to use for coding the **AR0** through **AR7** registers. The **USING** directive is specified as follows:

```
USING expression
```

where

expression is the register bank number which must be a value between 0 and 3.

The **USING** directive does not generate any code to change the register bank. Your program must make sure the correct register bank is selected. For example, the following code can be used to select register bank 2:

```
        PUSH PSW ;save PSW/register bank
        MOV PSW,#(2 SHL 3) ;select register bank 2
.
.
.
        ;function or subroutine body
.
.
```

Shaded directives and options are available only in AX51 and A251.

```
POP    PSW                ;restore PSW/register bank
```

The register bank selected by the **USING** directive is marked in the object file and the memory area required by the register bank is reserved by the Linker/Locator.

The value of **AR0** through **AR7** is calculated as the absolute address of **R0** through **R7** in the register bank specified by the **USING** directive. Some 8051 instruction (i.e. PUSH / POP) allow you to use only absolute register addresses. By default register bank 0 is assigned to the symbols **AR0** through **AR7**.

NOTE

*When the **EQU** directive is used to define a symbol for an **ARn** register, the address of the register **Rn** is calculated when the symbol is defined; not when it is used. If the **USING** directive subsequently changes the register bank, the defined symbol will not have the proper address of the **ARn** register and the generated code is likely to fail.*

Example

```
USING  3
PUSH   AR2                ; Push register 2 in bank 3

USING  1
PUSH   AR2                ; Push register 2 in bank 1
```

Other Directives

END

The **END** directive signals the end of the assembly module. Any text in the assembly file that appears after the **END** directive is ignored.

The **END** directive is required in every assembly source file. If the **END** statement is excluded, **Ax51** will generate a warning message.

Example

```
END
```

4

__ERROR__

The **__ERROR__** directive generates standard error messages that are report the same style as normal Ax51 assembler errors. The **__ERROR__** directive is specified as follows:

```
__ERROR__ text
```

where

text is the error text that should be displayed in the listing file. The error text is also displayed on the console if the “ERRORPRINT” control described on page 205 is used.

Example

```
IF CVAR1LEN > 10
  __ERROR__ "CVAR1 LEN EXCEEDS 10 BYTES"
ENDIF

$IF TESTVERS AND RELEASE
  __ERROR__ "TESTVERS GENERATED IN RELEASE MODE"
$ENDIF
```

Shaded directives and options are available only in AX51 and A251.

Chapter 5. Assembler Macros

A macro is a name that you assign to one or more assembly statements. For maximum flexibility the **Ax51** macro assembler provides three different macro languages:

- **Standard Assembler Macros:** are known from many other macro assemblers and allow you to define macros that look like standard assembler instructions. Refer to “Standard Macro Directives” on page 139 for a detailed description.
- **C Macros:** are known from ANSI C compilers and allow you to use common header files with constant definitions that can be used on the **Ax51** macro assembler as well as on the **Cx51** compiler. Refer to “C Macros” on page 156 for more information.
- **MPL Macros:** are compatible with the Intel ASM-51 and allow you to retranslate existing source files that initially written for this macro assembler. The assembler control **MPL** enables this macro processor. If you enable **MPL** macros the **C** Macros are disabled. Refer to “Chapter 6. Macro Processing Language” on page 163 for a detailed description.

A macro processor enables you to define and to use macros in your **x51** assembly programs. This section describes some of the features and advantages of using macros, lists the directives and operators that are used in macro definitions, and provides a number of example macros.

When you define a macro, you provide text (usually assembly code) that you want to associate with a macro name. Then, when you want to include the macro text in your assembly program, you provide the name of the macro. The **Ax51** assembler will replace the macro name with the text specified in the macro definition.

Macros provide a number of advantages when writing assembly programs.

- The frequent use of macros can reduce programmer induced errors. A macro allows you to define instruction sequences that are used repetitively throughout your program. Subsequent use of the macro will faithfully provide the same results each time. A macro can help reduce the likelihood of errors introduced in repetitive programming sequences. Of course, introduction of an error into a macro definition will cause that error to be duplicated where the macro is used.
- The scope of symbols used in a macro is limited to that macro. You do not need to be concerned about utilizing a previously used symbol name.
- Macros are well suited for the creation of simple code tables. Production of these tables by hand is both tedious and error prone.

A macro can be thought of as a subroutine call with the exception that the code that would be contained in the subroutine is included in-line at the point of the macro call. However, macros should not be used to replace subroutines. Each invocation of a subroutine only adds code to call the subroutine. Each invocation of a macro causes the assembly code associated with the macro to be included in-line in the assembly program. This can cause a program to grow rapidly if a large macro is used frequently. In a static environment, a subroutine is the better choice, since program size can be considerably reduced. But in time critical, dynamic programs, macros will speed the execution of algorithms or other frequently called statements without the penalty of the procedure calling overhead.

Use the following guidelines when deciding between macros or subroutines:

- Subroutines are best used when certain procedures are frequently executed or when memory space usage must be kept to a minimum.
- Macros should be used when maximum processor speed is required and when memory space used is of less importance.
- Macros can also be used to make repetitive, short assembly blocks more convenient to enter.

Standard Macro Directives

Ax51 provides a number of directives that are used specifically for defining macros. These directives are listed in the following table:

| Directive | Description |
|--------------|---|
| ENDM | Ends a macro definition. |
| EXITM | Causes the macro expansion to immediately terminate. |
| IRP | Specifies a list of arguments to be substituted, one at a time, for a specified parameter in subsequent lines. |
| IRPC | Specifies an argument to be substituted, one character at a time, for a specified parameter in subsequent lines. |
| LOCAL | Specifies up to 16 local symbols used within the macro. |
| MACRO | Begins a macro definition and specifies the name of the macro and any parameters that may be passed to the macro. |
| REPT | Specifies a repetition factor for subsequent lines in the macro. |

Refer to “Assembler Controls” on page 197 as well as the following sections for more information on these and other directives.

Defining a Macro

Macros must be defined in the program before they can be used. A macro definition begins with the **MACRO** directive which declares the name of the macro as well as the formal parameters. The macro definition must be terminated with the **ENDM** directive. The text between the **MACRO** and **ENDM** directives is called the macro body.

Example

```

WAIT          MACRO      X          ; macro definition
                  REPT      X          ; generate X NOP instructions
                  NOP
                  ENDM          ; end REPT
                  ENDM          ; end MACRO

```

In this example, `wait` is the name of the macro and `x` is the only formal parameter.

In addition to the **ENDM** directive, the **EXITM** directive can be used to immediately terminate a macro expansion. When an **EXITM** directive is detected, the macro processor stops expanding the current macro and resumes processing after the next **ENDM** directive. The **EXITM** directive is useful in conditional statements.

5

Example

```

WAIT          MACRO      X          ; macro definition
                  IF NUL X          ; make sure X has a value
                  EXITM          ; if not then exit
                  ENDIF

                  REPT      X          ; generate X NOP instructions
                  NOP
                  ENDM          ; end REPT
                  ENDM          ; end MACRO

```

Parameters

Up to 16 parameters can be passed to a macro in the invocation line. Formal parameter names must be defined using the **MACRO** directive.

Example

```
MNAME MACRO P1,P2,P3,P4,P5,P6,P7,P8,P9,P10,P11,P12,P13,P14,P15,P16
```

defines a macro with 16 parameters. Parameters must be separated by commas in both the macro definition and invocation. The invocation line for the above macro would appear as follows:

```
MNAME A,B,C,D,E,F,G,H,I,J,K,L,M,N,O,P
```

where **A**, **B**, **C**, ... **O**, **P** are parameters that correspond to the format parameter names **P1**, **P2**, **P3**, ... **P15**, **P16**.

Null parameters can be passed to a macro. Null parameters have the value **NULL** and can be tested for using the **NUL** operator described later in this chapter. If a parameter is omitted from the parameter list in the macro invocation, that parameter is assigned a value of **NULL**.

Example

```
MNAME A,,C,,E,,G,,I,,K,,M,,O,
```

P2, **P4**, **P6**, **P8**, **P10**, **P12**, **P14**, and **P16** will all be assigned the value **NULL** when the macro is invoked. You should note that there are no spaces between the comma separators in the above invocation line. A space has an ASCII value of 20h and is not equivalent to a **NULL**.

Labels

You can use labels within a macro definition. By default, labels used in a macro are global and if the macro is used more than once in a module, **Ax51** will generate an error.

Example

```

LOC  OBJ          LINE    SOURCE
                                1      GLABEL  MACRO
                                2      LOOP:   NOP
                                3              JMP     LOOP
                                4              ENDM
                                5
                                6
                                7              GLABEL
0000 00            8+1    LOOP:   NOP
0001 80FD          9+1    JMP     LOOP
                                10             GLABEL
                                11+1    LOOP:   NOP
***                ^
*** ERROR #9, LINE #11, ATTEMPT TO DEFINE AN ALREADY DEFINED LABEL
0003 80FB          12+1    JMP     LOOP
                                13
                                14
                                15      END

```

5

Labels used in a macro should be local labels. Local labels are visible only within the macro and will not generate errors if the macro is used multiple times in one source file. You can define a label (or any symbol) used in a macro to be local with the **LOCAL** directive. Up to 16 local symbols may be defined using the **LOCAL** directive.

NOTE

LOCAL must be in the next line after the **MACRO** definition.

Example

```
CLRMEM          MACRO      ADDR, LEN
                 LOCAL    LOOP
                 MOV      R7, #LEN
                 MOV      R0, #ADDR
                 MOV      A, #0
LOOP:           MOV      @R0, A
                 INC      R0
                 DJNZ    R7, LOOP
                 ENDM
```

In this example, the label `LOOP` is local because it is defined with the **LOCAL** directive. Any symbol that is not defined using the **LOCAL** directive will be a global symbol.

Ax51 generates an internal symbol for local symbols defined in a macro. The internal symbol has the form `??0000` and is incremented each time the macro is invoked. Therefore, local labels used in a macro are unique and will not generate errors.

Repeating Blocks

Ax51 provides the ability to repeat a block of text within a macro. The **REPT**, **IRP**, and **IRPC** directives are used to specify text to repeat within a macro. Each of these directives must be terminated with an **ENDM** directive.

REPT

The **REPT** directive repeats a block of text a fixed number of times. The following macro:

```

DELAY          MACRO                ;macro definition
                REPT      5          ;insert 5 NOP instructions
                NOP
                ENDM                ;end REPT block
                ENDM                ;end macro definition

```

inserts 5 NOP instructions when it is invoked.

Example

```

NOP
NOP
NOP
NOP
NOP

```

IRP

The **IRP** directive repeats a block once for each argument in a specified list. A specified parameter in the text block is replaced by each argument. The following macro:

```
CLRREGS      MACRO                                ; macro definition
              IRP  RNUM, <R0,R1,R2,R3,R4,R5,R6,R7>
              MOV  RNUM, #0
              ENDM                                ; end IRP
            ENDM                                  ; end MACRO
```

replaces the argument **RNUM** with **R0, R1, R2, ... R7**.

It generates the following code when invoked:

```
MOV  R0, #0
MOV  R1, #0
MOV  R2, #0
MOV  R3, #0
MOV  R4, #0
MOV  R5, #0
MOV  R6, #0
MOV  R7, #0
```

IRPC

The **IRPC** directive repeats a block once for each character in the specified argument. A specified parameter in the text block is replaced by each character. The following macro:

```
DEBUGOUT      MACRO                ; macro definition
               IRPC      CHR, <TEST>
               JNB       TI, $      ; wait for xmitter
               CLR       TI
               MOV       A, #'CHR'
               MOV       SBUF,A     ; xmit CHR
               ENDM      ; end IRPC
               ENDM      ; end MACRO
```

replaces the argument **CHR** with the characters **T**, **E**, **S**, and **T** and generates the following code when invoked:

```
JNB  TI, $ ; WAIT FOR XMITTER
CLR  TI
MOV  A, #'T'
MOV  SBUF,A ; XMIT T
JNB  TI, $ ; WAIT FOR XMITTER
CLR  TI
MOV  A, #'E'
MOV  SBUF,A ; XMIT E
JNB  TI, $ ; WAIT FOR XMITTER
CLR  TI
MOV  A, #'S'
MOV  SBUF,A ; XMIT S
JNB  TI, $ ; WAIT FOR XMITTER
CLR  TI
MOV  A, #'T'
MOV  SBUF,A ; XMIT T
```

Nested Definitions

Macro definitions can be nested up to nine levels deep.

Example

```
L1          MACRO
            LOCAL    L2
            L2      MACRO
                    INC    R0
                    ENDM
            MOV     R0, #0
            L2
            ENDM
```

The macro `L2` is defined within the macro definition of `L1`. Since the `LOCAL` directive is used to define `L2` as a local symbol, it is not visible outside `L1`. If you want to use `L2` outside of `L1`, exclude `L2` from the `LOCAL` directive symbol list.

Invocation of the `L1` macro generates the following:

```
MOV    R0, #0
INC    R0
```

Nested Repeating Blocks

You can also nest repeating blocks, specified with the `REPT`, `IRP`, and `IRPC` directives.

Example

```
PORTOUT          MACRO                                ; macro definition
                  IRPC    CHR, <Hello>
                  REPT    4                            ; wait for 4 cycles
                    NOP
                  ENDM                                  ; end REPT
                  MOV     A, #'CHR'
                  MOV     P0,A                          ; write CHR to P0
                  ENDM                                  ; end IRPC
                  ENDM                                  ; end MACRO
```

This macro nests a `REPT` block within an `IRPC` block.

Recursive Macros

Macros can call themselves directly or indirectly (via another macro). However, the total number of levels of recursion may not exceed nine. A fatal error will be generated if the total nesting level is greater than nine. The following example shows a recursive macro that is invoked by a non-recursive macro.

```

RECURSE      MACRO      X          ; recursive macro
IF X<>0
                RECURSE      %X-1
                ADD           A,#X      ; gen add a,#?
ENDIF
                ENDM

SUMM         MACRO      X          ; macro to sum numbers
                MOV           A,#0      ; start with zero
IF NUL X
                EXITM
ENDIF
IF X=0
                EXITM                ; exit if 0 argument
ENDIF

                RECURSE X          ; sum to 0
                ENDM

```

Operators

Ax51 provides a number of operators that may be used within a macro definition. The following table lists the operators and gives a description of each.

| Operator | Description |
|------------------|---|
| NUL | The NUL operator can be used to determine if a macro argument is NULL. NUL generates a non-zero value if its argument is a NULL. Non-NULL arguments will generate a value of 0. The NUL operator can be used with an IF control to enable condition macro assembly. |
| & | The ampersand character is used to concatenate text and parameters. |
| < > | Angle brackets are used to literalize delimiters like commas and blanks. Angle brackets are required when passing these characters to a nested macro. One pair of angle brackets is required for every nesting level. |
| % | The percent sign is used to prefix a macro argument that should be interpreted as an expression. When this operator is used, the numeric value of the following expression is calculated. That value is passed to the macro instead of the expression text. |
| :: | A double semicolon indicates that subsequent text on the line should be ignored. The remaining text is not processed or emitted. This helps to reduce memory usage. |
| ! | If an exclamation mark is used in front of a character, that character will be literalized. This allows character operators to be passed to a macro as a parameter. |

NUL Operator

When a formal parameter in a macro call is omitted, the parameter is given a value of `NULL`. You can check for `NULL` parameters by using the `NUL` operator within an `IF` control statement in the macro. The `NUL` operator requires an argument. If no argument is found, `NUL` returns a value of 0 to the `IF` control.

For example, the following macro definition:

```
EXAMPLE      MACRO    X
    IF NUL X
        EXITM
    ENDIF
ENDM
```

when invoked by:

```
EXAMPLE
```

will cause the `IF NUL X` test to pass, process the `EXITM` statement, and exit the macro expansion.

5

NOTE

A blank character (' ') has an ASCII value of 20h and is not equivalent to a NULL.

& Operator

The ampersand macro operator (&) can be used to concatenate text and macro parameters. The following macro declaration demonstrates the proper use of this operator.

```

MAK_NOP_LABEL          MACRO    X
LABEL&X:              NOP
                        ENDM

```

The `MAK_NOP_LABEL` macro will insert a new label and a NOP instruction for each invocation. The argument will be appended to the text `LABEL` to form the label for the line.

Example

| LOC | OBJ | LINE | SOURCE |
|------|-----|------|--|
| | | 1 | <code>MAK_NOP_LABEL</code> <code>MACRO</code> <code>X</code> |
| | | 2 | <code>LABEL&X:</code> <code>NOP</code> |
| | | 3 | <code>ENDM</code> |
| | | 4 | |
| | | 5 | |
| | | 6 | <code>MAK_NOP_LABEL</code> 1 |
| 0000 | 00 | 7+1 | <code>LABEL1:</code> <code>NOP</code> |
| | | 8 | <code>MAK_NOP_LABEL</code> 2 |
| 0001 | 00 | 9+1 | <code>LABEL2:</code> <code>NOP</code> |
| | | 10 | <code>MAK_NOP_LABEL</code> 3 |
| 0002 | 00 | 11+1 | <code>LABEL3:</code> <code>NOP</code> |
| | | 12 | <code>MAK_NOP_LABEL</code> 4 |
| 0003 | 00 | 13+1 | <code>LABEL4:</code> <code>NOP</code> |
| | | 14 | |
| | | 15 | <code>END</code> |

The `MAK_NOP_LABEL` macro is invoked in the above example in lines 6, 8, 10, and 12. The generated label and NOP instructions are shown in lines 7, 9, 11, and 13. Note that the labels are concatenated with the argument that is passed in the macro invocation.

< and > Operators

The angle bracket characters (<>) are used to enclose text that should be passed literally to macros. Some characters; for example, the comma; cannot be passed without being enclosed within angle brackets.

The following example shows a macro declaration and invocation passing an argument list within angle brackets.

```

1      FLAG_CLR      MACRO   FLAGS
2                      MOV   A, #0
3                      IRP   F, <FLAGS>
4                      MOV   FLAG&F, A
5                      ENDM
6                      ENDM
7
8      DSEG
0000   9      FLAG1:  DS 1
0001  10      FLAG2:  DS 1
0002  11      FLAG3:  DS 1
0003  12      FLAG4:  DS 1
0004  13      FLAG5:  DS 1
0005  14      FLAG6:  DS 1
0006  15      FLAG7:  DS 1
0007  16      FLAG8:  DS 1
0008  17      FLAG9:  DS 1
18
19      CSEG
20
21      FLAG_CLR      <1>
0000 7400   22+1      MOV   A, #0
23+1      IRP   F, <1>
24+1      MOV   FLAG&F, A
25+1      ENDM
0002 F500   26+2      MOV   FLAG1, A
27      FLAG_CLR      <1,2,3>
0004 7400   28+1      MOV   A, #0
29+1      IRP   F, <1,2,3>
30+1      MOV   FLAG&F, A
31+1      ENDM
0006 F500   32+2      MOV   FLAG1, A
0008 F501   33+2      MOV   FLAG2, A
000A F502   34+2      MOV   FLAG3, A
35      FLAG_CLR      <1,3,5,7>
000C 7400   36+1      MOV   A, #0
37+1      IRP   F, <1,3,5,7>
38+1      MOV   FLAG&F, A
39+1      ENDM
000E F500   40+2      MOV   FLAG1, A
0010 F502   41+2      MOV   FLAG3, A
0012 F504   42+2      MOV   FLAG5, A
0014 F506   43+2      MOV   FLAG7, A
.
.

```

In the previous example, the `FLAG_CLR` macro is declared to clear any of a number of flag variables. The `FLAGS` argument specifies a list of arguments that are used by the `IRP` directive in line 3. The `IRP` directive repeats the instruction `MOV FLAG&F, A` for each parameter in the `FLAGS` argument.

The `FLAG_CLR` macro is invoked in lines 21, 27, and 35. In line 21, only one parameter is passed. In line 27, three parameters are passed, and in line 35, four parameters are passed. The parameter list is enclosed in angle brackets so that it may be referred to as a single macro parameter, `FLAGS`. The code generated by the macro is found in lines 26, 32–34, and 40–43.

% Operator

The percent character (%) is used to pass the value of an expression to a macro rather than passing the literal expression itself. For example, the following program example shows a macro declaration that requires a numeric value along with macro invocations that use the percent operator to pass the value of an expression to the macro.

```

1  OUTPORT MACRO  N
2      MOV      A, #N
3      MOV      P0, A
4      ENDM
5
6
00FF 7  RESET_SIG EQU 0FFh
0000 8  CLEAR_SIG EQU 0
9
10
11      OUTPORT %(RESET_SIG AND NOT 11110000b)
0000 740F 12+1  MOV      A, #15
0002 F580 13+1  MOV      P0, A
14
15      OUTPORT %(CLEAR_SIG OR 11110000b)
0004 74F0 16+1  MOV      A, #240
0006 F580 17+1  MOV      P0, A

```

In this example, the expressions evaluated in lines 11 and 15 could not be passed to the macro because the macro expects a numeric value. Therefore, the expressions must be evaluated before the macro. The percent sign forces **Ax51** to generate a numeric value for the expressions. This value is then passed to the macro.

:: Operator

The double semicolon operator is used to signal that the remaining text on the line should not be emitted when the macro is expanded. This operator is typically used to precede comments that do not need to be expanded when the macro is invoked.

Example

```
REGCLR      MACRO    CNT
REGNUM      SET      0
             MOV     A, #0           ;; load A with 0
             REPT   CNT             ;; rpt for CNT registers
             MOV     R&REGNUM, A    ;; set R# to 0
             REGNUM SET %(REGNUM+1)
             ENDM
             ENDM
```

! Operator

The exclamation mark operator is used to indicate that a special character is to be passed literally to a macro. This operator enables you to pass comma and angle bracket characters, that would normally be interpreted as delimiters, to a macro.

Invoking a Macro

Once a macro has been defined, it can be called many times in the program. A macro call consists of the macro name plus any parameters that are to be passed to the macro.

In the invocation of a macro, the position of the actual parameters corresponds to the position of the parameter names specified in the macro definition. **Ax51** performs parameter substitution in the macro starting with the first parameter. The first parameter passed in the invocation replaces each occurrence of the first formal parameter in the macro definition, the second parameter that is passed replaces the second formal parameter in the macro definition, and so on.

If more parameters are specified in the macro invocation than are actually declared in the macro definition, **Ax51** ignores the additional parameters. If fewer parameters are specified than declared, **Ax51** replaces the missing parameters with a NULL character.

To invoke a macro in your assembly programs, you must first define the macro. For example, the following definition:

```
.
.
.
DELAY                MACRO    CNT    ;macro definition
                    REPT    CNT    ;insert CNT NOP instructions
                    NOP
                    ENDM          ;end REPT block
                    ENDM          ;end macro definition
.
.
.
```

defines a macro called `DELAY` that accepts one argument `CNT`. This macro will generate `CNT` NOP instructions. So, if `CNT` is equal to 3, the emitted code will be:

```
NOP
NOP
NOP
```

The following code shows how to invoke the `DELAY` macro from an assembly program.

```

.
.
.
LOOP:      MOV      P0, #0          ;clr PORT 0
           DELAY    5              ;wait 5 NOPs
           MOV      P0, #0ffh      ;set PORT 0
           DELAY    5              ;wait 5 NOPs
           JMP      LOOP           ;repeat
.
.
.

```

In this example, a value of 0 is written to port 0. The `DELAY` macro is then invoked with the parameter 5. This will cause 5 NOP instructions to be inserted into the program. A value of 0FFh is written to port 0 and the `DELAY` macro is invoked again. The program then repeats.

C Macros

5

The **Ax51** macro assembler has a standard C macro preprocessor that is almost identical with the macro preprocessors in the **Cx51** compiler. This allows you to use common header files with constant definitions that can be used in assembler and C source files. The **Ax51** macro assembler accepts also the special function register directives from the **Cx51** compiler. Therefore you may use the same SFR register definition files for both assembler and C source files.

NOTE

*C Macros are not available if you have enabled the Intel ASM-51 compatible MPL macro language with the **MPL** assembler control.*

C Macro Preprocessor Directives

C macro preprocessor directives must be the first non-whitespace text specified on a line. All directives are prefixed with the pound or number-sign character ('#'). For example:

```
#include <reg51f.h>
#if TEST
  #define DEBUG 1
#endif
```

The following table lists the preprocessor directives and gives a brief description of each.

| Directive | Description |
|----------------|--|
| define | Defines a preprocessor macro or constant. |
| elif | Initiates an alternative branch of the if condition, when the previous if, ifdef, ifndef, or elif branch was not taken. |
| else | Initiates an alternative branch when the previous if, ifdef, or ifndef branch was not taken. |
| endif | Ends an if , ifdef , ifndef , elif , or else block. |
| error | Outputs an error message defined by the user. This directive instructs the compiler to emit the specified error message. |
| ifdef | Evaluates an expression for conditional compilation. The argument to be evaluated is the name of a definition. |
| ifndef | Same as ifdef but the evaluation succeeds if the definition is not defined. |
| if | Evaluates an expression for conditional compilation. |
| include | Reads source text from an external file. The notation sequence determines the search sequence of the included files. Ax51 searches for include files specified with less-than/greater-than symbols ('<' '>') in the include file folder. The include file folder is specified with the INCDIR assembler control and with the environment variable C51INC and is therefore compatible with the Cx51 compiler. Ax51 searches for include files specified with double-quotes (" ") in the current folder, which is typically the folder of the project file. |
| line | Specifies a line number together with an optional filename. These specifications are used in error messages to identify the error position. |
| pragma | Allows you to specify assembler controls and are converted into Ax51 control lines. Refer to "Assembler Controls" on page 197 for more information. |
| undef | Deletes a preprocessor macro or constant definition. |

Stringize Operator

The stringize or number-sign operator (`#`), when used within a macro definition, converts a macro parameter into a string constant. This operator may be used only in a macro that has a specified argument or parameter list.

When the stringize operator immediately precedes the name of one of the macro parameters, the parameter passed to the macro is enclosed within quotation marks and is treated as a string literal. For example:

```
#define stringer(x)  DB #x, 0x0D, 0x0A  
stringer (text)
```

results in the following actual output from the preprocessor.

```
DB "text", 0x0D, 0x0A
```

NOTES

The Ax51 macro assembler does not accept C escape sequences like `"\n"`, `"\r"` or `"\x0d"`. You need to replace these characters with hex values.

Unlike the Cx51 compiler, multiple strings are not concatenated to a single string by the Ax51 macro assembler. Therefore you need to separate multiple items with a comma when using the Ax51 macro assembler.

Token-pasting Operator

The token-pasting operator (**##**) within a macro definition combines two arguments. It permits two separate tokens in the macro definition to be joined into a single token.

If the name of a macro parameter used in the macro definition is immediately preceded or followed by the token-pasting operator, the macro parameter and the token-pasting operator are replaced by the value of the passed parameter. Text that is adjacent to the token-pasting operator that is not the name of a macro parameter is not affected. For example:

```
TEST1 EQU 0x10
TEST2 EQU 0x20

#define paster(n) DB TEST##n

paster (2)
```

results in the following actual output from the preprocessor.

```
DB TEST2
```

Predefined C Macro Constants

Ax51 provides you with predefined constants to use in preprocessor directives and C code for more portable programs. The following table lists and describes each one.

| Constant | Description |
|-----------------------|---|
| <code>__A51__</code> | Allows you to identify the A51 assembler and returns the version number (for example, 600 for version 6.00). Only defined when using A51 . |
| <code>__AX51__</code> | Allows you to identify the AX51 assembler and returns the version number (for example, 100 for version 1.00). Only defined when using AX51 . |
| <code>__A251__</code> | Allows you to identify the A251 assembler and returns the version number (for example, 300 for version 3.00). Only defined when using A251 . |
| <code>__DATE__</code> | Date when the compilation was started. |
| <code>__FILE__</code> | Name of the file being compiled. |
| <code>__KEIL__</code> | Defined to 1 to indicate that you are using a development tool from Keil Software. |
| <code>__LINE__</code> | Current line number in the file being compiled. |
| <code>__TIME__</code> | Time when the compilation was started. |
| <code>__STDC__</code> | Defined to 1 to indicate full conformance with the ANSI C Standard. |

Examples with C Macros

The following assembler source file shows the usage of C Macros.

```
#if !defined ( __A51__ ) || __A51__ < 600
  #error "This source file requires A51 V6.00 or higher"
#endif

#pragma NOLIST
#include <reg52.h>      // register definition file for 80C52
#pragma LIST

#define TEST1  10
#define MYTEXT "Hello World"

#if TEST1 == 10
  DB MYTEXT
#endif

  DB "GENERATED: ", __DATE__

  MOV  R0,#TEST1 * 10

END
```

The listing file generated by A51 shows the text replacements performed by the C preprocessor:

| LOC | OBJ | LINE | SOURCE |
|------|----------|------|---------------------------------|
| | | 1 | |
| | | 4 | |
| | | 117 | \$LIST |
| | | 118 | |
| | | 119 | |
| | | 120 | |
| | | 121 | |
| | | 122 | |
| 0000 | 48656C6C | 123 | DB "Hello World" |
| 0004 | 6F20576F | | |
| 0008 | 726C64 | | |
| | | 124 | |
| 000B | 47454E45 | 125 | DB "GENERATED: ", "Jul 28 2000" |
| 000F | 52415445 | | |
| 0013 | 443A204A | | |
| 0017 | 756C2032 | | |
| 001B | 38203230 | | |
| 001F | 3030 | | |
| | | 126 | |
| 0021 | 7864 | 127 | MOV R0,#10 * 10 |
| | | 128 | |
| | | 129 | END |

C Preprocessor Side Effects

The integrated C preprocessor in **Ax51** has two side effects. This might cause problems when you translate programs that are written for previous Ax51 versions.

1. If you are using the backslash character at the end of a comment line, the next line will be a comment too.

```
; THIS IS A COMMENT ENDING WITH \  
MOV A,#0   DUE TO THE \ IN THE PREVIOUS LINE THE LINES A CONCATINATED  
; AND THE MOV INSTRUCTION WILL NOT BE TRANSLATED
```

2. If you are using \$INCLUDE in conditional assembly blocks, the file must exist even when the block will not be assembled.

```
$IF 0  
$INCLUDE (MYFILE.INC) ; this file must exist, even when the block  
                      ; is not translated, since the C preprocessor  
$ENDIF                ; interprets the file first.  
  
#if 0                 // with C preprocessor statements  
#include (myfile.inc) // the file needs not to exist  
#endif
```

Chapter 6. Macro Processing Language

The Macro Processing Language (MPL) is a string replacement facility. The macro processing language is enabled with the assembler control MPL and fully compatible to the Intel ASM-51 macro processing language. It permits you to write repeatedly used sections of code once and then insert that code at several places in your program. Perhaps MPL's most valuable capability is conditional assembly-with all microprocessors, compact configuration dependent code is very important to good program design. Conditional assembly of sections of code can help to achieve the most compact code possible.

Overview

The MPL processor views the source file in different terms than the assembler: to the assembler, the source file is a series of lines – control lines, and directive lines. To the MPL processor, the source file is a long string of characters.

All MPL processing of the source file is performed before your code is assembled. Because of this independent processing of the MPL macros and assembly of code, we must differentiate between macro-time and assembly-time. At macro-time, assembly language symbols and labels are unknown. SET and EQU symbols, and the location counter are also not known. Similarly, at assembly-time, no information about the MPL is known.

The MPL processor scans the source file looking for macro calls. A macro call is a request to the processor to replace the macro name of a built-in or user-defined macro by some replacement text.

Creating and Calling MPL Macros

The MPL processor is a character string replacement facility. It searches the source file for a macro call, and then replaces the call with the macro's return value. A % character signals a macro call.

The MPL processor function DEFINE creates macros. MPL processor functions are a predefined part of the macro language, and can be called without definition. The syntax for DEFINE is:

```
%[*]DEFINE (macro name) [parameter-list] (macro-body)
```

DEFINE is the most important macro processor function. Each of the symbols in the syntax above (macro name, parameter-list, and macro-body) are described in the following.

Creating Parameterless Macros

When you create a parameterless macro, there are two parts to a DEFINE call:

- **macro name**
The macro name defines the name used when the macro is called.
- **macro body**
The macro-body defines the return value of the call.

The syntax of a **parameterless macro** definition is shown below:

```
%*DEFINE (macro name) (macro-body)
```

The ‘%’ is the metacharacter that signals a macro call. The ‘*’ is the literal character. The use of the literal character is described later in this part.

Macro names have the following conventions:

- Maximum of 31 characters long
- First character: ‘A’ - ‘Z’, ‘a’ - ‘z’, ‘_’, or ‘?’
- Other characters: ‘A’ - ‘Z’, ‘a’ - ‘z’, ‘_’, ‘?’, ‘0’ - ‘9’

The macro-body is usually the replacement text of the macro call. However, the macro-body may contain calls to other macros. If so, the replacement text is actually the fully expanded macro-body, including the calls to other macros. When you define a macro using the syntax shown above, macro calls contained in the body of the macro are not expanded, until you call the macro.

The syntax of DEFINE requires that left and right parentheses surround the macro-body. For this reason, you must have balanced parentheses within the macro-body (each left parenthesis must have a succeeding right parenthesis, and each right parenthesis must have a preceding left parenthesis). We call character strings that meet these requirements balanced-text.

To call a macro, use the metacharacter followed by the macro name for the MPL macro. (The literal character is not needed when you call a user-defined macro.) The MPL processor will remove the call and insert the replacement text of the call. If the macro-body contains any call to other macros, they will be replaced with their replacement text.

Once a macro has been created, it may be redefined by a second DEFINE.

MPL Macros with Parameters

Parameters in a macro body allow you to fill in values when you call the MPL macro. This permits you to design a generic macro that produces code for many operations.

The term parameter refers to both the formal parameters that are specified when the macro is defined, and the actual parameters or arguments that are replaced when the macro is called.

The syntax for defining MPL macros with parameters is:

```
%*DEFINE (macro-name (parameter-list)) (macro-body)
```

The parameter-list is a list of identifiers separated by macro delimiters. The identifier for each parameter must be unique.

Typically, the macro delimiters are parentheses and commas. When using these delimiters, you would enclose the parameter-list in parentheses and separate each formal parameter with a comma. When you define a macro using parentheses and commas as delimiters, you must use those same delimiters, when you call that macro.

The macro-body must be a balanced-text string. To indicate the locations of parameter replacement, place the parameter's name preceded by the metacharacter in the macro-body. The parameters may be used any number of times and in any order within the macro-body. If a macro has the same name as one of the parameters, the macro cannot be called within the macro-body since this would lead to infinite recursion.

The example below shows the definition of a macro with three dummy parameters - SOURCE, DESTINATION, and COUNT. The macro will produce code to copy any number of bytes from one part of memory to another.

```
%*DEFINE (BMOVE (src, dst, cnt)) LOCAL lab (
    MOV R0, %%src
    MOV R1, %%dst
    MOV R2, %%cnt
%lab: MOV A, @R0
    MOV @R1, A
    INC R0
    INC R1
    DJNZ R2, %lab
)
```

To call the above macro, you must use the metacharacter followed by the macro's name similar to simple macros without parameters. However, a list of the actual parameters must follow. The actual parameters must be surrounded in the macro definition. The actual parameters must be balanced-text and may optionally contain calls to other macros. A simple program example with the macro defined above might be:

Assembler source text

```
%*DEFINE (BMOVE (src, dst, cnt)) LOCAL lab (
    MOV R0, #%src
    MOV R1, #%dst
    MOV R2, #%cnt
%lab: MOV A, @R0
    MOV @R1, A
    INC R0
    INC R1
    DJNZ R2, %lab
)

ALEN EQU 10 ; define the array size
DSEC SEGMENT IDATA ; define a IDATA segment
PSEC SEGMENT CODE ; define a CODE segment

RSEG DSEC ; activate IDATA segment
arr1: DS ALEN ; define arrays
arr2: DS ALEN

RSEG PSEC ; activate CODE segment
; move memory block
%BMOVE (arr1, arr2, ALEN)

END
```

The following listing shows the assembler listing of the above source code.

```

LOC      OBJ      LINE      SOURCE
          1
          2
00000A   3      ALEN EQU 10      ; define the array size
-----  4      DSEC SEGMENT IDATA ; define a IDATA segment
-----  5      PSEC SEGMENT CODE ; define a CODE segment
          6
-----  7          RSEG DSEC      ; activate IDATA segment
000000   8      arr1: DS ALEN      ; define arrays
00000A   9      arr2: DS ALEN
          10
-----  11          RSEG PSEC      ; activate CODE segment
          12      ; move memory block
          13      ; %BMOVE (arr1,arr2,ALEN)
          14      ;
          15      ;     MOV R0,##%src
          16      ;     MOV R1,##%dst
          17      ;     MOV R2,##%cnt
          18      ; %lab: MOV A,@R0
          19      ;     MOV @R1,A
          20      ;     INC R0
          21      ;     INC R1
          22      ;     DJNZ R2, %lab
          23
          24      ;     MOV R0,##%src
          25      ;     arr1
000000 7E0000 F 26      MOV R0,#arr1
          27      ;     MOV R1,##%dst
          28      ;     arr2
000003 7E1000 F 29      MOV R1,#arr2
          30      ;     MOV R2,##%cnt
          31      ;     ALEN
000006 7E200A 32      MOV R2,#ALEN
          33      ; %lab: MOV A,@R0
          34      ;LAB0
000009 A5E6   35      LAB0: MOV A,@R0
00000B A5F7   36          MOV @R1,A
00000D A508   37          INC R0
00000F A509   38          INC R1
          39      ;     DJNZ R2, %lab
          40      ;     LAB0
000011 A5DA00 F 41      DJNZ R2, LAB0
          42
          43      END

```

The example lists an assembled file that contains a macro definition in lines 1 to 9. The macro definition is listed with semicolons at start of each line. These semicolons are added by the assembler to prevent assembly of the definition text which is meaningful to the MPL preprocessor, but not to the remaining assembler phases. The listing only includes macro definitions or macro calls, if the control **GEN** is given.

The macro BMOVE is called in line 12 with three actual parameters. Lines 14 to 20 shows the macro expansion, which is the return value of the macro call. This text will be assembled.

The example will produce assembly errors because no section directives are included in the source file. The purpose here is to show MPL processing, not the assembler semantics.

Local Symbols List

The **DJNZ** instruction in the previous example uses a local label as the target of the branch. If you use a fixed label name (for example `xlab`, without a leading `%`), and you use the macro two or more times in the same assembly source file, errors will occur due to multiple definitions of a single name.

Local symbol definitions solve this problem. Local symbols are generated by the MPL processor as `local_symbol_nnn`, whereby `local_symbol` is the name of the local symbol and `nnn` is some number. Each time the macro is called, the number is automatically incremented. The resulting names are unique to each macro invocation.

The MPL processor increments a counter each time your program calls a macro that uses a LOCAL construct. The counter is incremented once for each symbol in the LOCAL list. Symbols in the LOCAL list, when used in the macro-body, receive a one to five digit suffix that is the decimal value of the counter. The first time you call a macro that uses the LOCAL construct, the suffix is 0.

The syntax for the LOCAL construct in the DEFINE functions is shown below:

```
%*DEFINE (macro-name (parameter-list)) [LOCAL local-list] (macro-body)
```

The local-list is a list of valid macro identifiers separated by spaces or commas. The LOCAL construct in a macro has no effect on the syntax of a macro call.

Macro Processor Language Functions

The MPL processor has several predefined macro processor functions. These MPL processor functions perform many useful operations that would be difficult or impossible to produce in a user-defined macro. An important difference between a user-defined macro and a MPL processor function is that user-defined macros may be redefined, while MPL processor functions can not be redefined.

We have already seen one of these MPL processor functions, `DEFINE`. `DEFINE` creates user defined macros. MPL processor functions are already defined when the MPL processor is started.

Comment Function

The MPL processing language can be very subtle, and the operation of macros written in a straightforward manner may not be immediately obvious. Therefore, it is often necessary to comment macro definitions. The **comment function** has the following syntax:

```
%'text'  
%'text end-of-line
```

The comment function always evaluates to the null string. Two terminating characters are recognized, the apostrophe and the end-of-line character. The second form allows you to spread macro definitions over several lines while avoiding unwanted end-of-lines in the return value. In either form, the text or comment is not evaluated for macro calls.

6

Example

```
%'this is macro comment.'      ; this is an assembler comment.  
%'the complete line including end-of-line is a comment
```

Source text before MPL processing

```
MOV    R5, R15    %'the following line will be kept separate'  
MOV    R1,        %'this comment eats the newline character'  
R12
```

Output text from MPL processor

```
MOV    R5, R15  
MOV    R1,        R12
```

Escape Function

Sometimes it is required to prevent the MPL processor from processing macro text. Two MPL processor functions perform this operation:

- escape function
- bracket function

The escape function interrupts scanning of macro text. The syntax of the **escape function** is:

```
%n text-n-characters-long
```

The metacharacter followed by a single decimal digit specifies the number of characters (maximum is 9) that are not evaluated. The escape function is useful for inserting a metacharacter (normally the % character), a comma, or a parenthesis.

Example

```
10%1% OF 10 = 1;   expands to:   10% OF 10 = 1;  
ASM%0251           expands to:   ASM251
```

Bracket Function

The other MPL processor function that inhibits the processing of macro text is the bracket function. The syntax of the **bracket function** is:

```
%(balanced-text)
```

The bracket function disables all MPL processing of the text contained within the parentheses. However, the escape function, the comment function, and parameter substitution are still recognized.

Since there is no restriction for the length of the text within the bracket function, it is usually easier to use than the escape function.

Example

```
ASM%(251)           evaluates to:   ASM251
%(1,2,3,4,5)       evaluates to:   1,2,3,4,5
```

Macro definition of 'DW'

```
)*DEFINE (DW (LIST, LABEL)) (
%LABEL:  DW      %LIST
)
```

Macro call to 'DW'

```
%DW (%(120, 121, 122, 123, -1), TABLE)
```

Return value of the macro call to 'DW'

```
TABLE:  DW      120, 121, 122, 123, -1
```

The macro above will add word definitions to the source file. It uses two parameters: one for the word expression list and one for the label name. Without the bracket function it would not be possible to pass more than one expression in the list, since the first comma would be interpreted as the delimiter separating the actual parameters to the macro. The bracket function used in the macro call prevents the expression list (120, 121, 122, 123, -1) from being evaluated as separate parameters.

METACHAR Function

The MPL processor function METACHAR allows the programmer to change the character that will be recognized by the MPL processor as the metacharacter. The use of this function requires extreme care.

The syntax of the **METACHAR** function is:

```
%METACHAR (balanced_text)
```

The first character of the balanced text is taken to be the new value of the metacharacter. The characters @, (,), *, blank, tab, and identifier-characters are not allowed to be the metacharacter.

Example

```
%METACHAR (!)          ; change metacharacter to '!'  
!(1,2,3,4)             ; bracket function invoked with !
```

Numbers and Expressions

Balanced text strings appearing in certain places in built-in MPL processor functions are interpreted as numeric expressions:

- The argument to evaluate function **'EVAL'**
- The argument to the flow of control functions **'IF'**, **'WHILE'**, **'REPEAT'** and **'SUBSTR'**.

Expressions are processed as follows:

- The text of the numeric expression will be expanded in the ordinary manner of evaluating an argument to a macro function.
- The resulting string is evaluated to both a numeric and character representation of the expressions result. The return value is the character representation.

The following operators are allowed (shown in order of precedence).

1. Parenthesized Expressions
2. HIGH, LOW
3. *, /, MOD, SHL, SHR
4. EQ, LT, LE, GT, GE, NE
5. NOT
6. AND, OR, XOR

The arithmetic is done using signed 16-bit integers. The result of the relational operators is either 0 (FALSE) or 1 (TRUE).

Numbers

Numbers can be specified in hexadecimal (base 16), decimal (base 10), octal (base 8) and binary (base 2). A number without an explicit base is interpreted as decimal, this being the default representation. The first character of a number must always be a digit between 0 and 9. Hexadecimal numbers which do not have a digit as the first character must have a 0 placed in front of them.

| Base | Suffix | Valid Characters | Examples |
|-------------|---------|--|-----------------------------|
| hexadecimal | H,h | 0 - 9, A-F (a - f) Hexadecimal numbers must be preceded with a 0, if the first digit is in range A to F | 1234H 99H 123H 0A0F0H 0FFH |
| decimal | D,d | 0 - 9 | 1234 65590D 20d 123 |
| octal | O,o,Q,q | 0 - 7 | 177O 7777o 25O 123o 177777O |
| binary | B,b | 0 - 1 | 1111B 10011111B 101010101B |

Dollar (\$) signs can be placed within the numbers to make them more readable. However a \$ sign is not allowed to be the first or last character of a number and will not be interpreted.

```
1111$0000$1010$0011B      is equivalent to      1111000010100011B
1$2$3$4                    is equivalent to          1234
```

Hexadecimal numbers may be also entered using the convention from the C language:

```
0xFE02      0x1234
0X5566      0x0A
```

Character Strings

The MPL processor allows ASCII characters strings in expressions. An expression is permitted to have a string consisting of one or two characters enclosed in single quote characters (').

| | |
|-------|---------------------------------------|
| 'A' | evaluates to 0041H |
| 'AB' | evaluates to 4142H |
| 'a' | evaluates to 0061H |
| 'ab' | evaluates to 6162H |
| " | the null string is not valid! |
| 'abc' | ERROR due to more than two characters |

The MPL processor cannot access the assembler's symbol table. The values of labels, SET and EQU symbols are not known during MPL processing. But, the programmer can define macro-time symbols with the MPL processor function 'SET'.

SET Function

The MPL processor function SET permits you to define macro-time symbols. SET takes two arguments: a valid identifier, and a numeric expression.

The syntax of the SET function is:

```
%SET (identifier, expression)
```

SET assigns the value of the numeric expression to the identifier.

The SET function affects the MPL processor symbol table only. Symbols defined by SET can be redefined with a second SET function call, or defined as a macro with DEFINE.

Source text

```
%SET (CNT, 3)
%SET (OFS, 16)
MOV R1, #%CNT+%OFS
%SET (OFS, %OFS + 10)
OFS = %OFS
```

Output text

```
MOV R1, #3+16
OFS = 26
```

The SET symbol may be used in the expression that defines its own value:

Source text

```
%SET (CNT, 10)           %' define variable CNT'
%SET (OFS, 20)           %' define variable OFS'
```

% 'change values for CNT and OFS'

```
%SET (CNT, %CNT+%OFS)   %' CNT = 30'
%SET (OFS, %OFS * 2)    %' OFS = 40'
MOV R2, #%CNT + %OFS    %' 70'
MOV R5, #%CNT           %' 30'
```

Output text

```
MOV R2, #30 + 40
MOV R5, #30
```

EVAL Function

The MPL processor function `EVAL` accepts an expression as an argument and returns the decimal character representation of its result.

The syntax of the `EVAL` function is:

```
%EVAL (expression)
```

The expression arguments must be a legal expression with already defined macro identifiers, if any.

Source text

```
%SET (CNT, 10)           %' define variable CNT'  
%SET (OFS, 20)           %' define variable OFS'  
  
MOV R15,##%EVAL (%CNT+1)  
MOV WR14,##%EVAL (14+15*200)  
MOV R13,##%EVAL (-(%CNT + %OFS - 1))  
MOV R2,##%EVAL (%OFS LE %CNT)  
MOV R7,##%EVAL (%OFS GE %CNT)
```

Output text

```
MOV R15,#11  
MOV WR14,#3014  
MOV R13,#-29  
MOV R2,#0  
MOV R7,#1
```

Logical Expressions and String Comparison

The following MPL processor functions compare two balanced-text string arguments and return a logical value based on that comparison. If the function evaluates to TRUE, then it returns a value of 1. If the function evaluates to FALSE, then it returns a value of 0. The list of string comparison functions below shows the syntax and describes the type of comparison made for each. Both arguments to these function may contain macro calls. (These MPL calls are expanded before the comparison is made).

| | |
|-------------------------------|---|
| <code>%EQS (arg1,arg2)</code> | True if both arguments are identical |
| <code>%NES (arg1,arg2)</code> | True if arguments are different in any way |
| <code>%LTS (arg1,arg2)</code> | True if first argument has a lower value than second argument |
| <code>%LES (arg1,arg2)</code> | True if first argument has a lower value then second argument or if both arguments are identical |
| <code>%GTS (arg1,arg2)</code> | True if first argument has a higher value than second argument |
| <code>%GES (arg1,arg2)</code> | True if first argument has a higher value than second argument or if both arguments are identical |

Example

| | |
|---------------------------------------|---|
| <code>%EQS (A251, A251)</code> | 0 (FALSE), the space after the comma is part of the second argument |
| <code>LT%S (A251,a251)</code> | 1 (TRUE), the lower case characters have a higher ASCII value than upper case |
| <code>%GTS (10,16)</code> | 0 (FALSE), these macros compare strings not numerical values. ASCII '6' is greater than ASCII '1' |
| <code>%GES (a251,a251)</code> | 0 (FALSE), the space at the end of the second argument makes the second argument greater than the first |
| <code>;%*DEFINE (VAR1) (A251)</code> | |
| <code>;%*DEFINE (VAR2) (%VAR1)</code> | |
| <code>%EQS (%VAR1,%VAR2)</code> | 1 (TRUE) expands to: |
| <code>%EQS (A251,A251)</code> | |

Conditional MPL Processing

Some MPL functions accept logical expressions as arguments. The MPL uses the value 1 and 0 to determine TRUE or FALSE. If the value is one, then the expression is TRUE. If the value is zero, then the expression is FALSE.

Typically, you will use either the relational operators (EQ, NE, LE, LT, GT, or GE) or the string comparison functions (EQS, NES, LES, LTS, GTS, or GES) to specify a logical value.

IF Function

The IF MPL function evaluates a logical expression, and based on that expression, expands or skips its text arguments. The syntax of the MPL processor function **IF** is:

```
%IF (expression) THEN (balanced-text1) [ ELSE (balanced-text2) ] FI
```

IF first evaluates the expression, if it is TRUE, then balanced-text1 is expanded; if it is FALSE and the optional ELSE clause is included, then balanced-text2 is expanded. If it is FALSE and the ELSE clause is not included, the IF call returns a null string. FI must be included to terminate the call.

IF calls can be nested; when they are, the ELSE clause refers to the most recent IF call that is still open (not terminated by FI). FI terminates the most recent IF call that is still open.

6

Source text

```

%*DEFINE (ADDSUB (op,p1,p2)) (
  %IF (%EQS (%op,ADD)) THEN (
    ADD    %p1,%p2
  )ELSE (%IF (%EQS (%op,SUB)) THEN (
    SUB    %p1,%p2
  ) FI
  ) FI
)

%ADDSUB (ADD,R15,R3)           %' generate ADD R15,R3'
%ADDSUB (SUB,R15,R9)           %' generate SUB R15,R9'
%ADDSUB (MUL,R15,R4)           %' generates nothing !'

```

Output text

```
ADD    R15,R3
SUB    R15,R9
```

WHILE Function

Often you may wish to perform macro operations until a certain condition is met. The MPL processor function **WHILE** provides this facility.

The syntax for the MPL processor function **WHILE** is:

```
%WHILE (expression) (balanced-text)
```

WHILE first evaluates the expression. If it is **TRUE**, then the *balanced-text* is expanded; otherwise, it is not. Once the *balanced-text* has been expanded, the logical argument is retested and if it is still **TRUE**, then the *balanced-text* is again expanded. This loop continues until the logical argument proves **FALSE**.

Since the MPL continues processing until expression evaluates to **FALSE**, the *balanced-text* should modify the expression, or the **WHILE** may never terminate.

A call to the MPL processor function **EXIT** will always terminate a **WHILE** function. **EXIT** is described later.

Source text

```
%SET (count, 5)                                %' initialize count to 5'
%WHILE (%count GT 0)
(  ADD    R15,R15 %SET (count, %count - 1)
)
```

Output text

```
ADD    R15,R15
ADD    R15,R15
ADD    R15,R15
ADD    R15,R15
ADD    R15,R15
```

REPEAT Function

The MPL processor function `REPEAT` expands its balanced-text a specified number of times. The syntax for the MPL processor function **REPEAT** is:

```
%REPEAT (expression) (balanced-test)
```

`REPEAT` uses the expression for a numerical value that specifies the number of times the balanced-text will be expanded. The expression is evaluated once when the macro is first called, then the specified number of iterations is performed.

Source text

```
%REPEAT (5)  
( -enter any key to shut down-  
)  
  
%REPEAT (5) (+%REPEAT (9) (-))+
```

Output text

```
-enter any key to shut down-  
-enter any key to shut down-  
-enter any key to shut down-  
-enter any key to shut down-  
-enter any key to shut down-
```

EXIT Function

The EXIT MPL processor function terminates expansion of the most recently called REPEAT, WHILE or user-defined macro function. It is most commonly used to avoid infinite loops (example: a WHILE that never becomes FALSE, or a recursive user-defined macro that never terminates). It allows several exit points in the same macro.

The syntax for the MPL processor function **EXIT** is:

```
%EXIT
```

Source text

```
%SET (count, 0)

%WHILE (1)
(%IF (%count GT 5) THEN (%EXIT)
FI    DW    %count, -%count
%SET (count, %count + 1))
```

Output text

```
DW 0, -0
DW 1, -1
DW 2, -2
DW 3, -3
DW 4, -4
DW 5, -5
```

String Manipulation Functions

The purpose of the MPL is to manipulate character strings. Therefore, there are several MPL functions that perform common character string manipulations.

LEN Function

The MPL processor function `LEN` returns the length of the character string argument in hexadecimal: The character string is limited to 256 characters.

The syntax for the MPL processor function `LEN` is:

```
%LEN (balanced-text)
```

Source text

```
%LEN (A251)                                %' len = 4 '  
%LEN (A251,A251)                            %' comma counts also '  
%LEN (  
%LEN (ABCDEFGHIJKLMNOPQRSTUVWXYZ)  
%DEFINE (TEXT) (QUEEN)  
%DEFINE (LENGTH) (%LEN (%TEXT))  
LENGTH OF '%TEXT' = %LENGTH.
```

Output text

```
4  
9  
0  
26  
LENGTH OF 'QUEEN' = 5.
```

SUBSTR Function

The MPL processor function SUBSTR returns a substring of the given text argument. The function takes three arguments: a character string to be divided and two numeric arguments.

The syntax for the MPL processor function **SUBSTR** is:

```
%SUBSTR (balanced-text, expression1, expression2)
```

Where balanced-text is any text argument, possibly containing macro calls. Expression1 specifies the starting character of the substring. Expression2 specifies the number of characters to be included in the substring.

If expression1 is zero or greater than the length of the argument string, then SUBSTR returns the null string. The index of the first character of the balanced text is one.

If expression2 is zero, then SUBSTR returns the null string. If expression2 is greater than the remaining length of the string, then all characters from the start character to the end of the string are included.

Source text

```
%DEFINE (STRING) (abcdefgh)  
%SUBSTR (%string, 1, 2)  
%SUBSTR (%(1,2,3,4,5), 3, 20)
```

Output text

```
ab  
2,3,4,5
```

MATCH Function

The MPL processor function MATCH searches a character string for a delimiter character, and assigns the substrings on either side of the delimiter to the identifiers.

The syntax for the MPL processor function **MATCH** is:

```
%MATCH (identifier1 delimiter identifier2) (balanced-text)
```

Identifier1 and identifier2 must be valid macro identifiers. Delimiter is the first character to follow identifier1. Typically, a space or comma is used, but any character that is not a macro identifier character may be used. Balanced-text is the text searched by the MATCH function. It may contain macro calls.

MATCH searches the balanced-text string for the specified delimiter. When the delimiter is found, then all characters to the left are assigned to identifier1 and all characters to the right are assigned to identifier2. If the delimiter is not found, the entire balanced-text string is assigned to identifier1 and the null string is assigned to identifier2.

Source text

```
%DEFINE (text) (-1,-2,-3,-4,-5)
%MATCH (next,list) (%text)
%WHILE (%LEN (%next) NE 0)
(
    MOV     R8, #next
    MOV     @WR2, R8 %MATCH (next,list) (%list)
    INC     WR2, #1
)

```

Output text

```
MOV     R8, #-1
MOV     @WR2, R8
INC     WR2, #1
MOV     R8, #-2
MOV     @WR2, R8
INC     WR2, #1
MOV     R8, #-3
MOV     @WR2, R8
INC     WR2, #1
MOV     R8, #-4
MOV     @WR2, R8
INC     WR2, #1
MOV     R8, #-5
MOV     @WR2, R8
INC     WR2, #1

```

Console I/O Functions

There are two MPL processor functions that perform console I/O: IN and OUT. Their names describe the function each performs. IN outputs a character '>' as a prompt, and returns the line typed at the console. OUT outputs a string to the console; a call to OUT is replaced by the null string.

The syntax for the MPL processor functions **IN** and **OUT** is:

```
%IN  
%OUT (balanced-text)
```

Source text

```
%OUT (enter baud rate)  
%set (BAUD_RATE,%in)  
BAUD_RATE = %BAUD_RATE
```

Output text

```
<19200 was entered at the console>  
BAUD_RATE = 19200
```

Advanced Macro Processing

The MPL definition function associates an identifier with a functional string. The macro may or may not have an associated pattern consisting of parameters and/or delimiters. Optionally present are local symbols.

The syntax for a **macro definition** is:

```
%DEFINE (macro_id define_pattern) [LOCAL id_list] (balanced_text)
```

The `define_pattern` is a balanced string which is further analyzed by the MPL processor as follows:

```
define_pattern = { [parm_id] [delimiter_specifier] }
```

`Delimiter_specifier` is one of the following:

- A string that contains no non-literal id-continuation, logical blank, or at character (`'@'`).
- `@delimiter_id`

The macro call must have a call pattern which corresponds to the macro define pattern. Regardless of the type of delimiter used to define a macro, once it has been defined, only delimiters used in the definition can be used in the macro call. Macros defined with parentheses and commas require parentheses and commas in the macro call. Macros defined with spaces or any other delimiter require that delimiter when called.

The define pattern may have three kinds of delimiters: implied blank delimiters, identifier delimiters and literal delimiters.

Literal Delimiters

The delimiters used in user-defined macros (parentheses and commas) are literal delimiters. A literal delimiter can be any character except the metacharacter.

When you define a macro using a literal delimiter, you must use exactly that delimiter when you call the macro. If the specified delimiter is not used as it appears in the definition, a macro error occurs.

When defining a macro, the delimiter string must be literalized, if the delimiter meets any of the following conditions:

- more than one character,
- a macro identifier character (A-Z, 0-9, _, or ?),
- a commercial at (@), a space, tab, carriage return, or linefeed.

Use the escape function (%) or the bracket function (%%) to literalize the delimiter string.

This is the simple form shown earlier:

| Before Macro Expansion | After Macro Expansion |
|---|-----------------------|
| <code>%%*DEFINE(MAC(A,B))(%%A %%B)</code> | null string |
| <code>%%MAC(4,5)</code> | 4 5 |

In the following example brackets are used instead of parentheses. The commercial at symbol separates parameters:

```
%%*DEFINE (MOV[A%(@)B]) (MOV %A,%B)    →    null string
%MOV [P0@P1]                            →    MOV P0,P1
```

In the next two examples, delimiters that could be id delimiters have been defined as literal delimiter (the differences are noted):

```
%%*DEFINE(ADD (R10 AND B)) (ADD R10,%B) →    null string
%ADD (R10 AND #27H)                →    ADD R10,#27H
```

Spaces around AND are considered as part of the argument string.

Blank Delimiters

Blank delimiters are the easiest to use. Blank delimiter is one or more spaces, tabs or new lines (a carriage-return/linefeed pair) in any order. To define a macro that uses the blank delimiter, simply place one or more spaces, tabs, or new lines surrounding the parameter list.

When the macro defined with the blank delimiter is called, each delimiter will match a series of spaces, tabs, or new lines. Each parameter in the call begins with the first non-blank character, and ends when a blank character is found.

Source text

```
%*DEFINE (X1 X2 X3) (P2=%X2, P3=%X3)
%X1 assembler A251
```

Output text

```
P2=assembler, P3=A251
```

Identifier Delimiters

Identifier delimiters are legal macro identifiers designated as delimiters. To define a macro that uses an identifier delimiter, you must prefix the delimiter with the @ symbol. You must separate the identifier delimiter from the macro identifiers (formal parameters or macro name) by a blank character.

When calling a macro defined with identifier delimiters, a blank delimiter is required to precede the identifier delimiter, but none is required to follow the identifier delimiter.

Source text

```
%*DEFINE (ADD X1 @TO X2 @STORE X3) (  
    MOV    R1,%X1  
    MOV    R2,%X2  
    ADD    R1,R2  
    MOV    %X3,R1  
)  
  
%ADD VAR1 TO VAR2 STORE VAR3
```

Output text

```
MOV    R1,VAR1  
MOV    R2,VAR2  
ADD    R1,R2  
MOV    VAR3,R1
```

Literal and Normal Mode

In normal mode, the MPL processor scans for the metacharacter. If it is found, parameters are substituted and macros are expanded. This is the usual operation of the MPL processor.

When the literal character (*) is placed in a DEFINE function, the MPL processor shifts to literal mode while expanding the macro. The effect is similar to surrounding the entire call with the bracket function. Parameters to the literalized call are expanded, the escape, comment, and bracket functions are also expanded, but no further processing is performed. If there are any calls to other macros, they are not expanded.

If there are no parameters in the macro being defined, the DEFINE function can be called without literal character. If the macro uses parameters, the MPL processor will attempt to evaluate the formal parameters in the macro-body as parameterless macro calls.

The following example illustrates the difference between defining a macro in literal mode and normal mode:

```
%SET (TOM, 1)
%*DEFINE (AB) (%EVAL (%TOM))
%DEFINE (CD) (%EVAL (%TOM))
```

When AB and CD are defined, TOM is equal to 1. The macro body of AB has not been evaluated due to the literal character, but the macro body of CD has been completely evaluated, since the literal character is not used in the definition. Changing the value of TOM has no effect on CD, but it changes the value of AB:

```
%SET (TOM, 2)      → null string
%AB                → 2
%CD                → 1
%*CD               → 1
%*AB               → %EVAL (%TOM)
```

MACRO Errors

The MPL processor emits error messages if errors occur in the MPL processing phase. Macro errors are displayed like other assembly errors in the listing file. The following table lists the error messages generated by the MPL processor.

| Number | Error Message and Description |
|--------|--|
| 200 | PREMATURE END OF FILE The end of the source module was reached while processing some macro call, which requires more input from the source file. |
| 201 | '<token>' IDENTIFIER EXPECTED The MPL processor expected an identifier while processing some macro. None was found. The unexpected token is displayed with this error message. |
| 202 | MPL FUNCTION '<name>': '<character>' EXPECTED The context of the MPL processor language requires a specific character from the input given by <character> while processing the built-in function given by <name>. |
| 203 | <string>: UNBALANCED PARENTHESES A balanced string requires the same number of right parentheses and left parentheses. |
| 204 | EXPECTED '<token>' The syntax requires a specific token to follow, for example THEN after the balanced text argument to IF. |
| 205 | INCOMPLETE MACRO DEFINITION The macro definition has not been completely processed due to premature end of input file. |
| 206 | FUNCTION 'MATCH': ILLEGAL CALL PATTERN The built-in function MATCH was called with an illegal call pattern. The call pattern must consist of some formal name followed by a delimiter specification and another formal name. |
| 207 | FUNCTION 'EXIT' IN BAD CONTEXT The built-in function EXIT is allowed only in the loop control constructs WHILE and REPEAT. |
| 208 | ILLEGAL METACHARACTER '<character>' The first character of the balanced text argument to METACHAR is taken to be the new value of the metacharacter. The characters @, (,), *, blank, tab, and identifier-characters are not allowed to be the metacharacter. |
| 209 | CALL PATTERN - DELIMITER '<delimiter>' NOT FOUND The call pattern of some macro does not conform to the define pattern of that macro. The delimiters of the macro call should be checked for conformance. |
| 210 | CALL TO UNDEFINED MACRO '<name>' The macro call specifies the name of an undefined macro. |

| Number | Error Message and Description |
|--------|--|
| 211 | INVALID MPL COMMAND '%<character>' The character following the metacharacter does not form a valid MPL command. |
| 212 | INVALID DIGIT '<character>' IN NUMBER A number of an expression contains an invalid digit. |
| 213 | UNCLOSED STRING OR CHARACTER CONSTANT |
| 214 | INVALID STRING OR CHARACTER CONSTANT The string representing a number in an expression is invalid. The string must be either one or two characters long. A character constant must not be longer than one character. Strings or character constants must be enclosed by single or double quotes. |
| 215 | UNKNOWN EXPRESSION IDENTIFIER The identifier within some expression is not an operator or a number. |
| 216 | <character>: INVALID EXPRESSION TOKEN The given character does not form a valid operator or an identifier operator. |
| 217 | DIV/MOD BY ZERO A division or modulo by zero error occurred while evaluating an expression. |
| 218 | EVAL: SYNTAX ERROR IN EXPRESSION The expression to be evaluated contains a syntax error, for example two consecutive numbers, not separated by an operator. |
| 219 | CAN'T OPEN FILE '<file>' The file specified in the INCLUDE directive could not be opened. |
| 220 | '<file>' IS NOT A DISK FILE The file name given in the INCLUDE directive does not specify a disk file. Files other than disk files are not allowed (example: CON). |
| 221 | ERROR IN INCLUDE DIRECTIVE The INCLUDE directive is ill-formed. The argument to INCLUDE must be the name of some file, enclosed in parentheses. |

Chapter 7. Invocation and Controls

This chapter explains how to use **Ax51** to assemble **x51** assembly source files and discusses the assembler controls that may be specified on the command line and within the source file.

Using the controls described in this chapter, you can specify which operations are performed by **Ax51**. For example, you can direct **Ax51** to generate a listing file, produce cross reference information, and control the amount of information included in the object file. You can also conditionally assemble sections of code using the conditional assembly controls.

Environment Settings

To run the **Ax51** macro assembler and the utilities from a Windows command prompt, you must create new entries in the environment table. In addition, you must specify a **PATH** for the compiler folder. The following table lists the environment variables, their default paths, and a brief description.

| Variable | Path | Description |
|----------------|--|--|
| PATH | KEIL\C51\BIN or KEIL\C251\BIN | This environment variable specifies the path of the Ax51 executable programs. |
| TMP | | This environment variable specifies which path to use for temporary files generated by the assembler. If the specified path does not exist, the assembler generates an error and aborts compilation. |
| C51INC | KEIL\C51\INC | This environment variable specifies the location of the standard C51 or CX51 include files. |
| C251INC | KEIL\C251\INC | This environment variable specifies the location of the standard C251 include files. |

Typically, these environment settings are automatically placed in your **AUTOEXEC.BAT** file. However, to put these settings in a separate batch file, use the following example as guideline:

```
PATH = C:\KEIL\C51\BIN
SET TMP = D:\
SET C51INC = C:\KEIL\C51\INC
```

Running Ax51

The Ax51 assembler is invoked by typing the program name at the Windows command prompt. On this command line, you must include the name of the assembler source file to be translated, as well as any other necessary assembler controls required to translate your source file. The format for the Ax51 command line is:

```
A51 sourcefile [directives...]
AX51 sourcefile [directives...]
A251 sourcefile [directives...]
```

or:

```
A51 @commandfile
AX51 @commandfile
A251 @commandfile
```

where

sourcefile is the name of the source program you want to assemble.

controls are used to direct the operation of the assembler. Refer to “Assembler Controls” on page 197 for more information.

commandfile is the name of a command input file that may contain *sourcefile* and *directives*. A *commandfile* is used, when the **Ax51** invocation line gets complex and exceeds the limits of the Windows command prompt.

The following command line example invokes **A251** macro assembler and specifies the source file **SAMPLE.A51** and uses the controls **DEBUG**, **XREF**, and **PAGEWIDTH**.

```
A251 SAMPLE.A51 DEBUG XREF PAGEWIDTH(132)
```

A251 displays the following information upon successful invocation and assembly.

```
A251 MACRO ASSEMBLER V3.00
ASSEMBLY COMPLETE. 0 ERROR(S) 0 WARNING(S)
```

ERRORLEVEL

After assembly, the number of errors and warnings detected is output to the screen. **Ax51** then sets the **ERRORLEVEL** to indicate the status of the assembly. The **ERRORLEVEL** values are identical for all the **Ax51** assembler, **Lx51** linker/locator and other **x51** utilities. The values are listed in the following table:

| ERROR LEVEL | Meaning |
|-------------|-----------------------------------|
| 0 | No ERRORS or WARNINGS |
| 1 | WARNINGS only |
| 2 | ERRORS and possibly also WARNINGS |
| 3 | FATAL ERRORS |

You can access the **ERRORLEVEL** variable in batch files for conditional tests to terminate the batch processing when an error occurs. Refer to the *Windows on-line help* for more information about **ERRORLEVEL** or batch files.

Output Files

Ax51 generates a number of output files during assembly. By default, these files use the same *basename* as the source file, but with a different file extension. The following table lists the files and gives a brief description of each.

| File Extension | Description |
|----------------------|---|
| <i>basename</i> .LST | Files with this extension are listing files that contain the formatted source text along with any errors detected by the assembler. Listing files may optionally contain symbols used and the generated assembly code. Refer to "PRINT / NOPRINT" on page 221 for more information. |
| <i>basename</i> .OBJ | Files with this extension are object modules that contain relocatable object code. Object modules can be linked into an absolute object module by the Lx51 Linker/Locator. Refer to "OBJECT / NOOBJECT" on page 219 for more information. |

Assembler Controls

Ax51 provides a number of controls that you can use to direct the operation of the assembler. Controls can be specified after the filename on the invocation

line or in a control line within the source file. Control lines are prefixed by the dollar sign character ('\$').

Example

```
A51 TESTFILE.A51 MPL DEBUG XREF
```

or

```
$MPL
$DEBUG
$XREF
```

or

```
$MPL DEBUG XREF
```

In the above example, **MPL**, **DEBUG**, and **XREF** are all control commands and **TESTFILE.A51** is the source file to assemble.

Ax51 has two classes of controls: primary and general. Primary controls are specified in the invocation line on the first few lines of the assembly source file. Primary controls remain in effect throughout the assembly. For this reason, primary controls may be used only in the invocation line or in control lines at the beginning of the program. Only other control lines that do not contain the **INCLUDE** control may precede a line containing a primary control. The **INCLUDE** control marks the end of any primary control specifications.

If a primary control is specified in the invocation line and on the first few lines of the assembly source file, the specification on the invocation line is used. This enables you override primary controls via the invocation line.

The general controls are used to control the immediate action of the assembler. Typically their status is set and modified during the assembly. Control lines containing only general controls may be placed anywhere in your source code.

The table on the next page lists all of the controls, their abbreviations, their default values, and a brief description of each.

7

NOTE

*Some controls like **EJECT** and **SAVE** cannot be specified on the command line. The syntax for each control is the same when specified on the command line or when specified within the source file. **Ax51** will generate a fatal error for controls that are improperly specified.*

| Directive | Page | Description |
|-----------------------------|------|---|
| CASE ‡ | 200 | AX51, A251 ONLY: enable case sensitive mode for symbol names. |
| COND / NOCOND | 201 | Enable or disable skipped sections to appear in the listing file. |
| DATE(date) ‡ | 202 | Places a date string in header (9 characters maximum). |
| DEBUG ‡ | 203 | Outputs debug symbol information to object file. |
| EJECT | 204 | Continue listing on next page. |
| ERRORPRINT[(file)] ‡ | 205 | Designates a file to receive error messages in addition to the listing. |
| FIXDRK ‡ | 206 | A251 ONLY: Replaces INC DRk with ADD DRk for C-Step devices. |
| GEN ‡ | 207 | Generates a full listing of macro expansions in the listing file. |
| NOGEN ‡ | 207 | List only the original source text in listing file. |
| INCDIR(path) | 208 | Define paths to be searched when a file is included via INCLUDE. |
| INCLUDE(file) | 209 | Designates a file to be included as part of the program. |
| INTR2 | 210 | A251 ONLY: Select 2-Byte interrupt frame size on 251 devices. |
| LIST, NOLIST | 211 | Print or do not print the assembler source in the listing file. |
| MOD51 ‡ | 212 | AX51 ONLY: Select classic 8051 instruction set (default). |
| MOD_MX51 ‡ | 212 | AX51 ONLY: Select Philips 80C51MX instruction set). |
| MOD_CONT ‡ | 212 | AX51 ONLY: Select Dallas 390 contiguous mode instruction set. |
| MODSRC ‡ | 213 | A251 ONLY: Select Intel/Atmel WM 251 source mode. |
| MPL ‡ | 214 | Enable Macro Processing Language. |
| NOLINES | 215 | Do not generate LINE number information. |
| NOMACRO ‡ | 216 | Disable Standard Macros |
| NOMOD51 | 217 | Do not recognize the 8051-specific predefined special register. |
| NOOBJECT | 219 | Designates that no object file will be created. |
| NOREGISTERBANK | 222 | Indicates that no banks are used. |
| NOSYMBOLS | 218 | No symbol table is listed. |
| NOSYMLIST | 225 | Do not list the following symbol definitions in the symbol table. |
| OBJECT[(file)] | 219 | Designate file to receive object code. |
| PAGELength(n) ‡ | 220 | Sets maximum number of lines in each page of listing file. |
| PAGEWIDTH(n) ‡ | 220 | Sets maximum number of characters in each line of listing file. |
| PRINT[(file)] ‡ | 221 | Designates file to receive source listing. |
| NOPRINT ‡ | 221 | Designates that no listing file will be created. |
| REGISTERBANK | 222 | Indicates one or more banks used in program module. |
| REGUSE | 223 | Defines register usage of assembler functions for the C optimizer. |
| RESTORE | 224 | Restores control setting from SAVE stack. |
| SAVE | 224 | Stores current control setting for GEN, LIST and SYMLIST. |
| SYMLIST | 225 | List the following symbol definitions in the symbol table. |
| TITLE(string) ‡ | 226 | Places a string in all subsequent page headers. |
| XREF ‡ | 227 | Creates a cross reference listing of all symbols used in program. |

‡ marks **general controls** that may be specified only once on the command line or at the beginning of a source file in a \$control line. They may not be used more than once in a source file.

CASE (AX51 and A251 only)

Abbreviation: CA

Arguments: None.

Default: No case sensitivity. All characters are converted to uppercase.

Control Class: Primary

µVision2 Control: Options – Ax51 – Case sensitive symbols.

Description: The **CASE** control directs the assembler to operate in case sensitive mode. Without **CASE**, the assembler operates in case insensitive mode and maps lowercase input characters to uppercase.

CASE becomes meaningful when modules generated by the assembler are combined with modules generated by the C compiler. Identifiers exported from C modules always appear in uppercase and lowercase (as written). Corresponding names used in an assembler module must match the case of the names from the C module.

Example:

```
$CASE  
AX51 SAMPLE.A51 CASE
```

COND / NOCOND

Abbreviation: None.

Arguments: None.

Default: **COND**

Control Class: General

µVision2 Control: Options – Listing – Assembler Listing – Conditional.

Description: The **COND** control directs the **Ax51** assembler to include unassembled parts of conditional **IF–ELSEIF–ENDIF** blocks in the listing file. Unassembled code is listed without line numbers.

The **NOCOND** control prevents unassembled portions of **IF–ELSE–ENDIF** blocks from appearing in the listing file.

Examples:

```
AX51 SAMPLE.A51 COND
$COND
AX51 SAMPLE.A51 NOCOND
$NOCOND
```

DATE

Abbreviation: DA

Arguments: A string enclosed within parentheses.

Default: The date obtained from the operating system.

Control Class: Primary

µVision2 Control: Options – Ax51 – Misc controls: enter the control.

Description: The **Ax51** assembler includes the current date in the header of each page in the listing file. The **DATE** control allows you to specify the date string that is included in the header. The string must immediately follow the **DATE** control and must be enclosed within parentheses. Only the first 8 characters of the date string are used. Additional characters are ignored.

Example:

```
AX51 SAMPLE.A51 DATE(19JAN00)
$DATE(10/28/00)
```

DEBUG

Abbreviation: DB

Arguments: None.

Default: No debugging information is generated.

Control Class: Primary

µVision2 Control: Options – Output – Debug Information

Description: The **DEBUG** control instructs the **Ax51** assembler to include debugging information in the object file. This information is used when testing the program with an emulator or simulator.

The **DEBUG** control also includes line number information for source level debugging. Line number information can be disabled with the **NOLINES** control.

Examples:

```
A51 SAMPLE.A51 DEBUG
$DEBUG
```

EJECT

Abbreviation: EJ

Arguments: None

Default: None

Control Class: General

µVision2 Control: This control cannot be specified on the command line.

Description: The **EJECT** control inserts a form feed into the listing file after the line containing the **EJECT** statement. This control is ignored if **NOLIST** or **NOPRINT** was previously specified.

Example: `$EJECT`

ERRORPRINT

Abbreviation: EP

Arguments: An optional filename enclosed within parentheses

Default: No error messages are output to the console.

Control Class: Primary

µVision2 Control: This control is used by µVision2 to get the error output. It should be not specified when you are using the µVision2 IDE.

Description: The **ERRORPRINT** control directs the **Ax51** assembler to output all error messages either to the console (if no filename is specified) or to a specified file.

Examples:

```
AX51 SAMPLE.A51 ERRORPRINT(SAMPLE.ERR)
AX51 SAMPLE2.A51 ERRORPRINT
$EP
```

FIXDRK (A251 only)

Abbreviation: FD

Arguments: None.

Default: Use the **INC DRk,#const** instruction.

Control Class: Primary

µVision2 Control: Options – A251 – Misc controls: enter the control.

Description: The **FIXDRK** control instructs the assembler to replace the **INC DRk,#const** instruction with the **ADD DRk,#const** instruction.

You may require this control because the **INC DRk,#const** instruction does not work in the Intel 251SB C-step CPU. Check the stepping level or contact your silicon vendor to find out if you need to use this control. If you are using the Intel 8xC251SB device and if you are in doubt about the stepping code, you should apply this control.

Examples:

```
A251 SAMPLE.A51 FIXDRK
$FIXDRK
```

GEN / NOGEN

Abbreviation: GE / NOGE

Arguments: None

Default: NOGEN

Control Class: General

µVision2 Control: Options – Listing – Assembler Listing – Macros.

Description: The **GEN** control directs the **Ax51** assembler to expand or list, in a listing file, all assembly instructions contained in a macro.

The **NOGEN** control prevents the **Ax51** assembler from including macro expansion text in the listing file. Only the macro name is listed.

Examples:

```
A51 SAMPLE.A51 GEN
$GEN
A51 SAMPLE.A51 NOGEN
$NOGEN
```

INCDIR

Abbreviation: ID

Arguments: Path specifications for include files enclosed in parentheses.

Default: None.

Control Class: General

µVision2 Control: Options – Ax51 – Include Paths.

Description: The **INCDIR** control specifies the location of files specified with the **INCLUDE** control. Multiple path declarations must be separated by semicolon characters (;). A maximum of 5 paths may be specified.

When searching for include files, the assembler searches first the current folder, which is typically the folder of the project file.. Then, paths specified by **INCDIR** are searched.

Example:

```
AX51 SAMPLE.A51 INCDIR(C:\AX51\MYINC;C:\CHIP_DIR)
```

INCLUDE

Abbreviation: IC

Arguments: A filename enclosed within parentheses.

Default: None.

Control Class: General

µVision2 Control: This control cannot be specified on the command line.

Description: The **INCLUDE** control directs the Ax51 assembler to include the contents of the specified file in the assembly of the program. The include file's contents are inserted immediately following the **INCLUDE** control line. **INCLUDE** files may be nested up to 9 levels deep.

The **INCLUDE** control is usually used to include special function register definition files for **x51** derivatives. It is also commonly used to include declarations for external routines, variables, and macros. Files containing assembly language code may also be included.

Example:

```
$INCLUDE (REG51F.INC)
```

The macro assembler searches the current folder and the folders specified with the **INCDIR** control for include files. If the specified file cannot be found in this folders, the assembler tries to locate the file in the folder *path_of_the_EXE_file*\\.\\ASM\\. In a typical installation of the tool chain this is the correct path for the derivate specific include files. (The \\C51\\BIN\\ or \\C251\\BIN folder contains the macro assembler and the \\C51\\ASM\\ or \\C251\\ASM\\ folder contains the register definition files).

INTR2 (A251 only)

Abbreviation: I2

Arguments: None.

Default: The A251 assembler assumes that an interrupt pushes 4 bytes onto the stack: a 24-bit return address and **PSW1**.

Control Class: General

µVision2 Control: Options – Target – 4 Byte interrupt frame size.

Description: The **INTR2** control informs the A251 assembler and the L251 linker/locator that the 251 CPU saves the low order 16 bits of the program counter but does not automatically save **PSW1** when entering an interrupt.

The **INTR2** control does not change any assembler code or instruction encoding. It only informs the linker and debugging tools of the interrupt frame size assumed for interrupt functions. The linker uses this information to check the consistency of the interrupt frame sizes between program modules. If the interrupt frame sizes of the object modules differ, the L251 linker/locator generates a warning message.

Example:

```
A251 SAMPLE.A51 INTR2
$INTR2
```

LIST / NOLIST

Abbreviation: LI / NOLI

Arguments: None

Default: LIST

Control Class: General

µVision2 Control: Options – Ax51 – Misc controls: enter the control.

Description: The **LIST** control directs the **Ax51** assembler to include the program source text in the generated listing file.

The **NOLIST** control prevents subsequent lines of your assembly program from appearing in the generated listing file.

If a line that would normally not be listed causes an assembler error, that line will be listed along with the error message.

Examples:

```
AX51 SAMPLE.A51 LI
$LIST
AX51 SAMPLE.A51 NOLIST
$NOLI
```

MOD51, MOD_CONT, MOD_MX51 (AX51 only)

Abbreviation: M51, MC, MX

Arguments: None

Default: **MOD51:** generate code for classic 8051.

Control Class: Primary

µVision2 Control: Options – Target (mode selection depends on the device).

Description: The **MODxxx** controls selects the instruction set that is used in the application code.

The **MOD51** control is the default setting of AX51 and instructs the assembler to generate code with that uses only the instructions of the classic 8051.

The **MOD_MX51** control enables the instruction set extensions for the Philips 80C51MX architecture. If you are using a device with this architecture, at least one module must be translated with this directive. You can intermix code that has been written for the classic 8051 in a project for the Philips 80C51MX.

The **MOD_CONT** control enables the 24-bit contiguous address mode that is available on some Dallas devices. If you are using this mode, you need to translate all modules with this directive. It is not possible to use code that has been translated for the classic 8051 when you are using this CPU mode.

Examples:

```
AX51 SAMPLE.A51 MOD_MX51
AX51 SAMPLE.A51 MOD_CONT

$MX      ; generate code for Philips 80C51MX architecture
$MC      ; generate code for Dallas 24-bit contiguous mode
```

MODSRC (A251 only)

Abbreviation: MS

Arguments: None

Default: Generate code for binary mode of the Intel/Atmel WM 251 CPU.

Control Class: Primary

µVision2 Control: Options – Target – CPU Mode.

Description: The **MODSRC** control instructs the A251 assembler to generate code for the Intel/Atmel WM 251 architecture using the SOURCE mode of this CPU.

Examples:

```
A251 SAMPLE.A51 MODSRC
$MODSRC
```

MPL

Abbreviation: None

Arguments: None

Default: The Macro Processing Language is disabled.

Control Class: Primary.

µVision2 Control: Options – Ax51 – Macro processor – MPL.

Description: The **MPL** control enables the Macro Processing Language. The **MPL** language is compatible to the Intel ASM51. Refer to “Chapter 6. Macro Processing Language” on page 163 for more information about the MPL processor.

Examples:

```
A251 SAMPLE.A51 MPL
$MPL
```

NOLINES

Abbreviation: NOLN

Arguments: None.

Default: Line numbers for source level debugging are generated when the **DEBUG** control is used.

Control Class: Primary

µVision2 Control: Options – Ax51 – Misc controls: enter the control.

Description: The **NOLINES** control disables the line number information for source level debugging. This control is useful when the **Ax51** assembler is used with very old debugging tools and very old emulators.

Examples:

```
A251 SAMPLE.A51 NOLINES
$NOLINES
```

NOMACRO

Abbreviation: None.

Arguments: None.

Default: Standard Macros are fully expanded.

Control Class: Primary

µVision2 Control: Options – Ax51 – Macro processor – Standard.

Description: The **NOMACRO** control disables the standard macro facility of the **Ax51** assembler so that standard macros are not expanded.

Examples:

```
A251 SAMPLE.A51 NOMACRO
$NOMACRO
```

NOMOD51

Abbreviation: NOMO

Arguments: None.

Default: The A51 assembler pre-defines all special function registers of the 8051 CPU. The A251 assembler and the AX51 assembler do not pre-define any CPU special function registers.

Control Class: Primary

µVision2 Control: Options – Ax51 – Special Function Registers – Define 8051 SFR Names.

Description: The **NOMOD51** control prevents the A51 assembler from implicitly defining symbols for the default 8051 special function registers. This is necessary when you want to include a definition file to declare symbols for the special function registers of a different 8051 derivative.

The A251 assembler and the AX51 assembler support the **NOMOD51** control only for source compatibility to the A51. However, the 8051 special function registers are not predefined in A251 or AX51.

Examples:

```
A251 SAMPLE.A51 NOMO
$NOMOD51
```

NOSYMBOLS

Abbreviation: SB / NOSB

Arguments: None

Default: The **Ax51** assembler generates a table of all symbols used in and by the assembly program module. This symbol table is included in the generated listing file.

Control Class: Primary

µVision2 Control: Options – Listing – Assembler Listing – Symbols

Description: The **NOSYMBOLS** control prevents the **Ax51** assembler from generating a symbol table in the listing file.

Examples:

```
A251 SAMPLE.A51 SYMBOLS
$SB
A251 SAMPLE.A51 NOSB
$NOSYMBOLS
```

OBJECT / NOOBJECT

Abbreviation: OJ / NOOJ

Arguments: An optional filename enclosed within parentheses.

Default: OBJECT (*basename.OBJ*)

Control Class: Primary

µVision2 Control: Options – Output – Select Folder for Objects

Description: The **OBJECT** control specifies that the **Ax51** assembler generate an object file. The default name for the object file is *basename.OBJ*, however, an alternate filename may be specified in parentheses immediately following the **OBJECT** control statement.

The **NOOBJECT** control prevents the **Ax51** assembler from generating an object file.

Examples:

```
A51 SAMPLE.A51 OBJECT (OBJDIR\SAMPLE.OBJ)
OJ (OBJ\SAMPLE.OBJ)
A251 SAMPLE.A51 NOOJ
$NOOBJECT
```

PAGELength, PAGEWidth

Abbreviation: PL, PW

Arguments: **PAGELength** accepts a number between 10 and 65535; **PAGEWidth** accepts a number between 78 and 132 enclosed within parentheses.

Default: **PAGELength (60)**
PAGEWidth (120)

µVision2 Control: Options – Listing – Page Length / Page Width

Description: The **PAGELength** control specifies the number of lines printed per page in the listing file. The number must be a decimal value between 10 and 65535. The default is 60.

The **PAGEWidth** control specifies the maximum number of characters in a line in the listing file. Lines that are longer than the specified width are automatically wrapped around to the next line. The default number of characters per line is 120.

Example:

```
A251 SAMPLE.A51 PAGELength(132) PAGEWidth (79)
$PL (66)
$PW(132)
```

PRINT / NOPRINT

Abbreviation: PR / NOPR

Arguments: An optional filename enclosed within parentheses.

Default: PRINT(*basename.LST*)

Control Class: Primary

µVision2 Control: Options – Listing – Select Folder for List Files

Description: The **PRINT** control directs the **Ax51** assembler to generate a listing file. The default name for the listing file is *basename.LST*, however, an alternate filename may be specified in parentheses immediately following the **PRINT** control statement.

The **NOPRINT** control prevents the **Ax51** assembler from generating a listing file.

Examples:

```
A251 SAMPLE.A51 PRINT
A51TESTPRG.A51 PR (TESTPRG1.LST)
$PRINT (LPT1)
AX51 SAMPLE.A51 NOPRINT
$NOPR
```

REGISTERBANK / NOREGISTERBANK

Abbreviation: RB / NORB

Arguments: Register bank numbers separated by commas and enclosed within parentheses. For example, **RB (1,2,3)**.

Default: REGISTERBANK (0)

Control Class: Primary

µVision2 Control: Options – A51 – Misc controls: enter the control.

Description: The **REGISTERBANK** control specifies the register banks used in a source module. This information is stored in the generated object file for further processing by the **Lx51** linker/locator.

The **NOREGISTERBANK** control specifies that the **A51** assembler reserve no memory for the register bank. This is useful for assembler modules that should be used in a generic library. Since this library might be called with any active register bank, you may use the **NOREGISTERBANK** directive. Thus the program that calls the library module must reserve the register bank that is in use.

Examples:

```
A251 RBUSER.A51 REGISTERBANK (0,1,2)
$RB (0,3)

A51 SAMPLE.A51 NOREGISTERBANK
$NORB
```

REGUSE

Abbreviation: RU

Arguments: Name of a PUBLIC symbol and a register list enclosed in parentheses.

Default: Not applicable.

Control Class: General

µVision2 Control: This control cannot be specified on the command line.

Description: The **REGUSE** control specifies the registers modified during a function's execution. This control may be used in combination with the C51 Compiler or C251 Compiler to allow global register optimization for functions written in assembly language. For more information about global register optimization refer to the *C Compiler User's Guide*.

The **REGUSE** control may not be specified on the A251 assembler invocation line.

Examples:

```
$REGUSE MYFUNC (ACC, B, R0 - R7)
$REGUSE PROCA (DPL, DPH)
$REGUSE PUTCHAR (R6, R7, CY, ACC)
```

SAVE / RESTORE

Abbreviation: SA / RS

Arguments: None

Default: None

Control Class: General

µVision2 Control: This control cannot be specified on the command line.

Description: The **SAVE** control stores the current settings of the **LIST** and **GEN** controls. Subsequent controls can modify the **LIST** and **GEN** settings.

This control allows these settings to be saved, altered for a number of program lines, and restored using the **RESTORE** control. The **SAVE** control can be nested up to 9 levels deep.

The **RESTORE** control fetches and restores the values of the **GEN** and **LIST** controls that were stored by the last **SAVE** control statement.

Example:

```
.  
.   
.   
$SAVE   
$NOLIST   
$INCLUDE (SAMPLE.INC)   
$RESTORE   
.   
.   
. 
```

SYMLIST / NOSYMLIST

Abbreviation: SL/NOSL

Arguments: None.

Default: SYMLIST

Control Class: General

µVision2 Control: Options – Ax51 – Misc controls: enter the control.

Description: The **SYMLIST** control lists symbol definitions in the symbol table.

The **NOSYMLIST** control prevents the **Ax51** assembler from listing symbol definitions in the symbol table. The **NOSYMLIST** control is useful in special function register definition files or other files where symbols are not desired in the symbol table.

Examples:

```
A251 SAMPLE.A51 NOSYMLIST
$NOSYMLIST
$INCLUDE (REG251S.H)
$SYMLIST
```

TITLE

Abbreviation: TT

Arguments: A string enclosed within parentheses.

Default: The *basename* of the source file excluding the extension.

Control Class: General

µVision2 Control: Options – Ax51 – Misc controls: enter the control.

Description: The **TITLE** control allows you to specify the title to use in the header line of the listing file. The text used for the title must immediately follow the **TITLE** control and must be enclosed in parentheses. A maximum of 60 characters may be specified for the title. If the **TITLE** control is not used, the module name specified with the “NAME” directive described on page 132 will be used as title string.

Example:

```
A251 SAMPLE.A51 TITLE(Oven Controller Version 3)
$TT(Race Car Controller)
```

XREF

Abbreviation: XR

Arguments: None.

Default: No error references are listed.

µVision2 Control: Options – Listing – Assembler Listing – Cross Reference

Description: The **XREF** control directs the **Ax51** assembler to generate a cross reference table of the symbols used in the source module. The alphabetized cross reference table will be included in the generated listing file. Refer to “Assembler Listing File Format” on page 415 for an example of a cross reference table.

Example:

```
AX51 SAMPLE.A51 XREF
$XREF
```

Controls for Conditional Assembly

The controls for conditional assembly are General controls—they may be specified any number of times in the body of a source file. Conditional assembly may be used to implement different program versions or different memory models with one source file. You may use conditional assembly to maintain one source module that satisfies several applications.

Conditional text blocks are enclosed by **IF**, **ELSEIF**, **ELSE** and **ENDIF**.

The **SET** and **RESET** controls may be used in the invocation line of the assembler to set and reset conditions tested by the **IF** and **ELSEIF** controls.

The remaining instructions for conditional assembly are only allowed within the source file and cannot be part of the assembler invocation line.

IF blocks may be nested a maximum of 10 levels deep. If a block is not translated, conditional blocks nested within it are also skipped.

Conditional Assembly Controls

Conditional assembly controls allow you to write **x51** assembly programs with sections that can be included or excluded from the assembly based on the value of a constant expression. Blocks that are conditionally assembled are enclosed by **IF**, **ELSEIF**, **ELSE**, and **ENDIF** control statements.

The conditional control statements **IF**, **ELSE**, **ELSEIF**, and **ENDIF** may be specified only in the source program. They are not allowed on the invocation line. Additionally, these controls may be specified both with and without the leading dollar sign (\$).

When prefixed with a dollar sign, the conditional control statements may only access symbols defined by the **SET** and **RESET** controls.

When specified without a dollar sign, the conditional control statements may access all symbols except those defined by the **SET** and **RESET** controls. These control statements may access parameters in a macro definition.

The following table lists the conditional assembly control statements.

| Directive | Page | Description |
|---------------|------|--|
| IF | 233 | Translate block if condition is true |
| ELSE | 235 | Translate block if the condition of a previous IF is false. |
| ELSEIF | 234 | Translate block if condition is true and a previous IF or ELSEIF is false. |
| ENDIF | 236 | Marks end of a block. |
| RESET | 232 | Set symbols checked by IF or ELSEIF to false. |
| SET | 231 | Set symbols checked by IF or ELSEIF to true or to a specified value. |

Predefined Constants (A251 only)

The A251 macro assembler provides you with predefined constants to use in conditional \$IF / \$ELSEIF controls for more portable assembler modules. The following table lists and describes each one.

| Constant | Description |
|-------------------------|---|
| <code>__INTR4__</code> | Set to 1 to when A251 assumes 4 byte interrupt frames. If the A251 control INTR2 is used, the <code>__INTR4__</code> symbol is not defined. |
| <code>__MODBIN__</code> | Set to 1 if the binary mode of 251 CPU is used. If the source mode is specified with the MODSRC control, the <code>__MODBIN__</code> symbol is not defined. |
| <code>__MODSRC__</code> | Set to 1 if the source mode of 251 CPU is specified with the MODSRC control. If the binary mode of the 251 CPU is used the <code>__MODSRC__</code> symbol is not defined. |

SET

Abbreviation: None.

Arguments: A list of symbols with optional value assignments separated by commas and enclosed within parentheses. For example:

SET (*symbol* [= *number*] [, *symbol* [= *number*] ...])

Default: None.

Control Class: General

µVision2 Control: Options – Ax51 – Set.

Description: The **SET** control assigns numeric values to the specified symbols. Symbols that do not include an explicit value assignment are assigned the value 0FFFFh. Symbols that are specified with an equal sign (=) and a numeric value are assigned the specified value.

These symbols can be used in **IF** and **ELSEIF** control statements for conditional assembly. They are only used for conditional assembly. These symbols are administered separately and do not interfere with other symbols.

Example:

```
A251 SAMPLE.A51 SET(DEBUG1=1, DEBUG2=0, DEBUG3=1)
$SET (TESTCODE = 0)
$SET (DEBUGCODE, PRINTCODE)
```

RESET

Abbreviation: None.

Arguments: A list of symbols separated by commas and enclosed within parentheses. For example:

RESET (*symbol* [, *symbol* ...])

Default: None

Control Class: General

µVision2 Control: Options – Ax51 – Reset.

Description: The **RESET** control assigns a value of 0000h to the specified symbols. These symbols may then be used in **IF** and **ELSEIF** control statements for conditional assembly. These symbols are only used for conditional assembly. They are administered separately and do not interfere with other symbols.

Example:

```
A251 SAMPLE.A51 RESET(DEBUG1, DEBUG2, DEBUG3)

$RESET (TESTCODE)

$RESET (DEBUGCODE, PRINTCODE)
```

IF

Abbreviation: None

Arguments: A numeric expression

Default: None

Control Class: General

µVision2 Control: This control cannot be specified on the command line.

Description: The **IF** control begins an **IF–ELSE–ENDIF** construct that is used for conditional assembly. The specified numeric expression is evaluated and, if it is non-zero (TRUE), the **IF** block is assembled. If the expression is zero (FALSE), the **IF** block is not assembled and subsequent blocks of the **IF** construct are evaluated.

IF blocks can be terminated by an **ELSE**, **ELSEIF**, or **ENDIF** control statement.

Example:

```
.
.
.
$IF (DEBUG_VAR = 3)
.
.
.
Version_3:      MOV    DPTR, #TABLE_3
.
.
.
$ ENDIF
.
.
.
```

ELSEIF

Abbreviation: None

Arguments: A numeric expression.

Default: None

µVision2 Control: This control cannot be specified on the command line.

Description: The **ELSEIF** control is used to introduce an alternative program block after an **IF** or **ELSEIF** control. The **ELSEIF** block is only assembled if the specified numeric expression is non-zero (TRUE) and if previous **IF** and **ELSEIF** conditions in the **IF-ELSE-ENDIF** construct were FALSE. **ELSEIF** blocks are terminated by an **ELSEIF**, **ELSE**, or **ENDIF** control.

Example:

```
.
.
.
$IF SWITCH = 1                ; Assemble if switch is 1
.
.
.
$ELSEIF SWITCH = 2           ; Assemble if switch is 2
.
.
.
$ELSEIF SWITCH = 3           ; Assemble if switch is 3
.
.
.
$ENDIF
.
.
.
```

ELSE

Abbreviation: None.

Arguments: None.

Default: None.

Control Class: General

µVision2 Control: This control cannot be specified on the command line.

Description: The **ELSE** control is used to introduce an alternative program block after an **IF** or **ELSEIF** control. The **ELSE** block is only assembled if previous **IF** and **ELSEIF** conditions in the **IF-ELSE-ENDIF** construct were all **FALSE**. **ELSE** blocks are terminated with an **ENDIF** control.

Example:

```
.
.
.
$IF (DEBUG)          ; TRUE when DEBUG <> 1
.
.
.
$ELSEIF (TEST)
.
.
.
$ELSE
.
.
.
$ENDIF
.
.
.
```

ENDIF

Abbreviation: None

Arguments: None

Default: None

Control Class: General

µVision2 Control: This control cannot be specified on the command line.

Description: The **ENDIF** control terminates an **IF–ELSE–ENDIF** construct. When the **Ax51** assembler encounters an **ENDIF** control statement, it concludes processing the **IF** block and resumes assembly at the point of the **IF** block. Since **IF** blocks may be nested, this may involve continuing in another **IF** block. The **ENDIF** control must be preceded by an **IF**, **ELSEIF**, or **ELSE** control block.

Example:

```
.  
.   
.   
$IF TEST  
.   
.   
$ENDIF  
.   
.   
.
```

Chapter 8. Error Messages

This chapter lists the error messages generated by **Ax51**. The following sections include a brief description of the possible error messages along with a description of the error and any corrective actions you can take to avoid or eliminate the error.

Fatal errors terminate the assembly and generate a message that is displayed on the console. Non-fatal errors generate a message in the assembly listing file but do not terminate the assembly.

Fatal Errors

Fatal errors cause immediate termination of the assembly. These errors usually occur as a result of an invalid command line. Fatal errors are also generated when the assembler cannot access a specified source file or when the macros are nested more than 9 deep.

Fatal errors produce a message that conforms to one of the following formats:

```
A251 FATAL ERROR -
      FILE:                <file in which the error occurred>
      LINE:                <line in which the error occurred
      ERROR:               <corresponding error message>
A251 TERMINATED.
```

or

```
A251 FATAL ERROR -
      ERROR:               <error message with description>
A251 TERMINATED.
```

where

FILE is the name of an input file that could not be opened.
LINE is the line where the error occurred
ERROR is the fatal error message text explained below.

Fatal Error Messages

ATTEMPT TO SHARE FILE

A file is used both for input and output (e.g. list file uses the same name as the source file).

BAD NUMERIC CONSTANT

The numeric argument to the given control is illegal.

CAN'T ATTACH FILE

The given file can't be opened for read access.

CAN'T CREATE FILE

The given file can't be opened for write/update access.

CAN'T HAVE GENERAL CONTROL IN INVOCATION LINE

The given control is allowed in \$control lines within the source file only (for example the **EJECT** control). Some controls are allowed only in the source text and not in the command line. Refer to “Chapter 7. Invocation and Controls” on page 195 for more information about the A251 controls.

CAN'T REMOVE FILE

The given temporary file could not be removed for some reason.

CONFLICTING CONTROL

The given control conflicts with an earlier control (for example **\$NOMOD251 MODSRC**).

CONTROL LINE TOO LONG (500)

A \$-control line has more than 500 characters.

DISK FILE REQUIRED

The given file does not represent a disk file.

ERRORPRINT- AND LIST-FILE CANNOT BE THE SAME

It is illegal to direct the listing file output and the errorprint output to the console at the same time.

EXPECTED DELIMITER '(' AFTER CONTROL

The given control requires a brace enclosed argument

EXPECTED DELIMITER ')' AFTER ARGUMENT

The given control requires a brace enclosed argument

FILE DOES NOT EXIST

The given file does not exist.

FILE IS READ ONLY

The given file does not permit write/update access.

FILE WRITE ERROR

The given file could not be written to (check free space)

IDENTIFIER EXPECTED

The given control requires an identifier as it's argument, for example **SET (VAR1=1234H)**.

ILLEGAL FILE NAME, VOLUME OR DIRECTORY NAME

The name of the file is invalid or designates an invalid file.

INVOCATION LINE TOO LONG

The invocation line is longer than 500 characters.

LIMIT EXCEEDED: BALANCED TEXT LENGTH

The maximum length of a balanced text string is 65000 characters.

LIMIT EXCEEDED: INCLUDE OR MACRO NESTING

The maximum nesting level for MPL-macros is 50. The maximum nesting level of standard macros plus include files is 10.

LIMIT EXCEEDED: MACRO DEFINITION LENGTH

The maximum definition length of a standard macro is 20000 characters. MPL macros are limited to 65000 characters.

LIMIT EXCEEDED: MORE THAN 16000 SYMBOLS

The number of symbols (labels, equ/set symbols, externals, segment-symbols) must not exceed 16000 per source file.

LIMIT EXCEEDED: SOURCE LINE LENGTH (500)

A single source line must not exceed the 500 characters per line limit.

LIMIT EXCEEDED: TOO MANY EXTERNALS (65535)

The number of external symbols must not exceed 65535 per source module.

LIMIT EXCEEDED: TOO MANY EXTERNALS (65535)

The number of externals must not exceed 65535 per source module.

LIMIT EXCEEDED: TOO MANY SEGMENTS (65535)

The number of segments must not exceed 65535 per source module.

NON-NULL ARGUMENT EXPECTED

The argument to the given control must not be null (for example **\$PRINT()**).

OUT OF MEMORY

The assembler has run out of memory. Remove unnecessary drivers from your system configuration.

OUT OF RANGE NUMERIC VALUE

The numeric argument to the given control is out of range (for example **\$PAGEWIDTH(3000)**).

UNKNOWN CONTROL

The given control is undefined.

Non-Fatal Errors

Non-fatal errors usually occur within the source program and are typically syntax errors. When one of these errors is encountered, the assembler attempts to recover and continue processing the input file. As more errors are encountered, the assembler will produce additional error messages. The error messages that are generated are included in the listing file.

Non-fatal errors produce a message using the following format:

```
*** ERROR number IN line (file, LINE line): error message
```

or

```
*** WARNING number IN line (file, LINE line): warning message
```

where

| | |
|----------------------|---|
| <i>number</i> | is the error number. |
| <i>line</i> | corresponds to the logical line number in the source file. |
| <i>file</i> | corresponds to the source or include file which contains the error. |
| <i>LINE</i> | corresponds to the physical line number in <file>. |
| <i>error message</i> | is descriptive text and depends on the type of error encountered. |

The logical line number in the source file is counted including the lines of all include files and may therefore differ from the physical line number. For that reason, the physical line number and the associated source or include file is also given in error and warning messages.

Example

```

11                MOV     R0,# 25 * | 10
*** -----^
*** ERROR #4 IN 11 (TEST.A51, LINE 11), ILLEGAL CHARACTER
```

The caret character (^) is used to indicate the position of the incorrect character or to identify the point at which the error was detected. It is possible that the position indicated is due to a previous error. If a source line contains more than one error, the additional position indicators are displayed on subsequent lines.

The following table lists the non-fatal error messages that are generated by A251. These messages are listed by error number along with the error message and a brief description of possible causes and corrections.

| Number | Non-Fatal Error Message and Description |
|--------|---|
| 1 | <p>ILLEGAL CHARACTER IN NUMERIC CONSTANT</p> <p>This error indicates that an invalid character was found in a numeric constant. Numeric constants must begin with a decimal digit and are delimited by the first non-numeric character (with the exception of the dollar sign). The base of the number decides which characters are valid.</p> <ul style="list-style-type: none"> • Base 2: 0, 1 and the base indicator B • Base 8: 0–7 and the base indicator O or Q • Base 10: 0–9 and the base indicator D or no indicator • Base 16: 0–9, A–F and the base indicator H • Base 16: 0xhhh, 0–9, and A–F |
| 2 | <p>MISSING STRING TERMINATOR</p> <p>The ending string terminator was missing. The string was terminated with a carriage return.</p> |
| 3 | <p>ILLEGAL CHARACTER</p> <p>The assembler has detected a character which is not in the set of valid characters for the 51/251 assembler language (for example `).</p> |
| 4 | <p>BAD INDIRECT REGISTER IDENTIFIER</p> <p>This error occurs if combined registers are entered incorrectly; e.g., @R7, @R3, @PC+A, @DPTR+A.</p> |
| 5 | <p>ILLEGAL USE OF A RESERVED WORD</p> <p>This error indicates that a reserved word is used for a label.</p> |
| 6 | <p>DEFINITION STATEMENT EXPECTED</p> <p>The first symbol in the line must be part of a definition. For example: VAR1 EQU 12</p> |
| 7 | <p>LABEL NOT PERMITTED</p> <p>A label was detected in an invalid context.</p> |
| 8 | <p>ATTEMPT TO DEFINE AN ALREADY DEFINED LABEL</p> <p>A label was defined more than once. Labels may be defined only once in the source program.</p> |
| 9 | <p>SYNTAX ERROR</p> <p>Ax51 encountered an error processing the line at the specified token.</p> |

| Number | Non-Fatal Error Message and Description |
|--------|---|
| 10 | <p>ATTEMPT TO DEFINE AN ALREADY DEFINED SYMBOL</p> <p>An attempt was made to define a symbol more than once. The subsequent definition was ignored.</p> |
| 11 | <p>STRING CONTAINS ZERO OR MORE THAN TWO CHARACTERS</p> <p>Strings used in an expression can be a maximum of two characters long (16 bits).</p> |
| 12 | <p>ILLEGAL OPERAND</p> <p>An operand was expected but was not found in an arithmetic expression. The expression is illegal.</p> |
| 13 | <p>') ' EXPECTED</p> <p>A right parenthesis is expected. This usually indicates an error in the definition of external symbols.</p> |
| 14 | <p>BAD RELOCATABLE EXPRESSION</p> <p>A relocatable expression may contain only one relocatable symbol which may be a segment symbol, external symbol, or a symbol belonging to a relocatable segment. Mathematical operations cannot be carried out on more than one relocatable symbol.</p> |
| 15 | <p>MISSING FACTOR</p> <p>A constant or a symbolic value is expected after an operator.</p> |
| 16 | <p>DIVIDE BY ZERO ERROR</p> <p>A division by zero was attempted while calculating an expression. The value calculated is undefined.</p> |
| 17 | <p>INVALID BASE IN BIT ADDRESS EXPRESSION</p> <p>This error indicates that the byte base in the bit address is invalid. This occurs if the base is outside of the range 20h–2Fh or if it lies between 80h and 0FFh and is not evenly divisible by 8. For the 251 chip, the byte base address must be in range 20H-0FFH with no restrictions. Note that with symbolic operands, the operand specifies an absolute bit segment or an addressable data segment.</p> |
| 18 | <p>OUT OF RANGE OR NON-TYPELESS BIT-OFFSET</p> <p>The input of the offset (base.offset) in a bit address must be a typeless absolute expression with a value between 0 and 7.</p> |
| 19 | <p>INVALID REGISTER FOR EQU/SET</p> <p>The registers R0–R7, A and C may be used in SET or EQU directives. No other registers are allowed.</p> |

| Number | Non-Fatal Error Message and Description |
|--------|--|
| 20 | <p>INVALID SIMPLE RELOCATABLE EXPRESSION</p> <p>A simple relocatable expression is intended to represent an address in a relocatable segment. External symbols as well as segment symbols are not allowed. The expression however may contain more symbols of the same segment. Simple relocatable expressions are allowed in the instructions ORG, EQU, SET, CODE, XDATA, IDATA, BIT, DATA, DB and DW.</p> |
| 21 | <p>EXPRESSION WITH FORWARD REFERENCE NOT PERMITTED</p> <p>Expressions in EQU and SET directives may not contain forward references.</p> |
| 22 | <p>EXPRESSION TYPE DOES NOT MATCH INSTRUCTION</p> <p>The expression does not conform to the x51 conventions. A #, /Bit, register, or numeric expression was expected.</p> |
| 23 | <p>NUMERIC EXPRESSION EXPECTED</p> <p>A numeric expression is expected. The expression of another type is found.</p> |
| 24 | <p>SEGMENT-TYPE EXPECTED</p> <p>The segment type of a definition was missing or invalid.</p> |
| 25 | <p>RELOCATION-TYPE EXPECTED</p> <p>An invalid relocation type for a segment definition was encountered.</p> |
| 26 | <p>INVALID RELOCATION-TYPE</p> <p>The types PAGE and INPAGE are only allowed for the CODE/ECODE and XDATA segments. INBLOCK/INSEG is only allowed for the CODE/ECODE segments and BITADDRESSABLE is only for the DATA segment (maximum length 16 Bytes). EBITADDRESSABLE is allowed for DATA segments (maximum length 96 Bytes). The type UNIT is the default for all segment types if no input is entered.</p> |
| 27 | <p>LOCATION COUNTER MAY NOT POINT BELOW SEGMENT-BASE</p> <p>An ORG directive used in a segment defined by the AT address directive may not specify an offset that lies below the segment base. The following example is, therefore, invalid:</p> <pre>CSEG AT 1000H ORG 800H</pre> |
| 28 | <p>ABSOLUTE EXPRESSION REQUIRED</p> <p>The expression in a DS or DBIT instruction must be an absolute typeless expression. Relocatable expressions are not allowed.</p> |

| Number | Non-Fatal Error Message and Description |
|--------|--|
| 29 | <p>SEGMENT-LIMIT EXCEEDED</p> <p>The maximum limit of a segment was exceeded. This limit depends on the segment and relocation type. Segments with the attribute DATA should not exceed 128 bytes. BITADDRESSABLE segments should not exceed 16 bytes and INPAGE segments should not exceed 2 KBytes.</p> |
| 30 | <p>SEGMENT-SYMBOL EXPECTED</p> <p>The operand to an RSEG directive must be a segment symbol.</p> |
| 31 | <p>PUBLIC-ATTRIBUTE NOT PERMITTED</p> <p>The PUBLIC attribute is not allowed on the specified symbol.</p> |
| 32 | <p>ATTEMPT TO RESPECIFY MODULE NAME</p> <p>An attempt was made to redefine the name of the module by using a second NAME directive. The NAME directive may only appear once in a program.</p> |
| 33 | <p>CONFLICTING ATTRIBUTES</p> <p>A symbol may not contain the attributes PUBLIC and EXTRN simultaneously.</p> |
| 34 | <p>' , ' EXPECTED</p> <p>A comma is expected in a list of expressions or symbols.</p> |
| 35 | <p>' (' EXPECTED</p> <p>A left parenthesis is expected at the indicated position.</p> |
| 36 | <p>INVALID NUMBER FOR REGISTERBANK</p> <p>The expression in a REGISTERBANK control must be an absolute typeless number between 0 and 3.</p> |
| 37 | <p>OPERATION INVALID IN THIS SEGMENT</p> <p>x51 instructions are allowed only within CODE/ECODE segments.</p> |
| 38 | <p>NUMBER OF OPERANDS DOES NOT MATCH INSTRUCTION</p> <p>Either too few or too many operands were specified for the indicated instruction. The instruction was ignored.</p> |
| 39 | <p>REGISTER-OPERAND EXPECTED</p> <p>A register operand was expected but an operand of another type was found.</p> |
| 40 | <p>INVALID REGISTER</p> <p>The specified register operand does not conform to the x51 conventions.</p> |

| Number | Non-Fatal Error Message and Description |
|--------|---|
| 41 | <p>MISSING 'END' STATEMENT</p> <p>The last instruction in a source program must be the END directive. The preceding source is assembled correctly and the object is valid.</p> |
| 42 | <p>INTERNAL ERROR (PASS-2), CONTACT TECHNICAL SUPPORT</p> <p>Occurs if a symbol in pass 2 contains a value different than in pass 1.</p> |
| 43 | <p>RESPECIFIED PRIMARY CONTROL, LINE IGNORED</p> <p>A control was repeated or conflicts with a previous control. The control statement was ignored.</p> |
| 44 | <p>MISPLACED PRIMARY CONTROL, LINE IGNORED</p> <p>A primary control was misplaced. Primary controls may be entered in the invocation line or at the beginning of the source file (as \$ instruction). The processing of primary controls in a source file ends when the first non empty/non comment line containing anything but a primary control is processed.</p> |
| 45 | <p>UNDEFINED SYMBOL (PASS-2)</p> <p>The symbol is undefined.</p> |
| 46 | <p>CODE/ECODE-ADDRESS EXPECTED</p> <p>An operand of memory type CODE/ECODE or a typeless expression is expected.</p> |
| 47 | <p>XDATA-ADDRESS EXPECTED</p> <p>An operand of memory type XDATA or a typeless expression is expected.</p> |
| 48 | <p>DATA-ADDRESS EXPECTED</p> <p>An operand of memory type DATA or a typeless expression is expected.</p> |
| 49 | <p>IDATA-ADDRESS EXPECTED</p> <p>An operand of memory type 'IDATA' or a typeless expression is expected.</p> |
| 50 | <p>BIT-ADDRESS EXPECTED</p> <p>An operand of memory type BIT or a typeless expression is expected.</p> |
| 51 | <p>TARGET OUT OF RANGE</p> <p>The target of a conditional jump instruction is outside of the +127/-128 range or the target of an AJMP or ACALL instruction is outside the 2 KByte memory block.</p> |

| Number | Non-Fatal Error Message and Description |
|--------|--|
| 52 | <p>VALUE HAS BEEN TRUNCATED TO 8 BITS</p> <p>The result of the expression exceeds 255 decimal. Only the 8 low-order bits are used for the byte operand.</p> |
| 53 | <p>MISSING 'USING' INFORMATION</p> <p>The absolute register symbols AR0 through AR7 can be used only if a USING register bank directive was specified. This error indicates that the USING directive is missing and the assembler cannot assign data addresses to the register symbols.</p> |
| 54 | <p>MISPLACED CONDITIONAL CONTROL</p> <p>An ELSEIF, ELSE, or ENDIF control must be preceded by an IF instruction.</p> |
| 55 | <p>BAD CONDITIONAL EXPRESSION</p> <p>The expression to the IF or ELSEIF control is invalid. These expressions must be absolute and may not contain relocatable symbols.</p> <p>The \$IF and \$ELSEIF can only access symbols defined with the \$SET and \$RESET controls. Both IF and ELSEIF allow access to all symbols of the source program.</p> |
| 56 | <p>UNBALANCED IF-ENDIF-CONTROLS</p> <p>Each IF block must be terminated with an ENDIF control. This is also true with skipped nested IF blocks.</p> |
| 57 | <p>SAVE STACK UNDERFLOW</p> <p>A \$RESTORE control instruction is then valid only if a \$SAVE control was previously given.</p> |
| 58 | <p>SAVE STACK OVERFLOW</p> <p>The context of the GEN, COND, and LIST controls may be stored by the \$SAVE control up to a maximum of 9 levels.</p> |
| 59 | <p>MACRO REDEFINITION</p> <p>An attempt was made to define an already defined macro.</p> |
| 60 | <p>Not generated by Ax51.</p> |
| 61 | <p>MACRO TERMINATED BY END OF FILE, MISSING 'ENDM'</p> <p>An attempt was made to define an already defined macro.</p> |
| 62 | <p>TOO MANY FORMAL PARAMETERS (16)</p> <p>The number of formal parameters to a macro is limited to 16.</p> |

| Number | Non-Fatal Error Message and Description |
|--------|---|
| 63 | <p>TOO MANY LOCALS (16) The number of local symbols within a macro is limited to 16.</p> |
| 64 | <p>DUPLICATE LOCAL/FORMAL The number of local or formal identifier must be distinct.</p> |
| 65 | <p>IDENTIFIER EXPECTED While parsing a macro definition, an identifier was expected but something different was found.</p> |
| 66 | <p>'EXITM' INVALID OUTSIDE A MACRO The EXITM (exit macro) keyword is illegal outside a macro definition.</p> |
| 67 | <p>EXPRESSION TOO COMPLEX A too complex expression was encountered. This error occurs, if the number of operands and operators in one expression exceeds 50.</p> |
| 68 | <p>UNKNOWN CONTROL OR BAD ARGUMENT(S) The control given in a \$-control line or the argument(s) to some control are invalid.</p> |
| 69 | <p>MISPLACED ELSEIF/ELSE/ENDIF CONTROL These controls require a preceding IF control.</p> |
| 70 | <p>LIMIT EXCEEDED: IF-NESTING (10) IF controls may be nested up to a level of 10.</p> |
| 71 | <p>NUMERIC VALUE OUT OF RANGE The value of a numeric expression is out of range (for example \$PAGEWIDTH (2048) where only values in range 80 to 132 are allowed).</p> |
| 72 | <p>TOO MANY TOKENS IN SOURCE LINE The number of tokens (identifiers, operators, punctuation characters and end of line) exceeds 200. The source line is truncated at 200 tokens.</p> |
| 72 | <p>TOO MANY TOKENS IN SOURCE LINE The number of tokens (identifiers, operators, punctuation characters and end of line) exceeds 200. The source line is truncated at 200 tokens.</p> |
| 73 | <p>TEXT FOUND BEYOND END STATEMENT - IGNORED Text following the END directive is not processed by the assembler.</p> |

| Number | Non-Fatal Error Message and Description |
|--------|--|
| 74 | <p>REGISTER USAGE: UNDEFINED REGISTER NAME</p> <p>A register name argument given to the REGUSE control does not represent the name of a register.</p> |
| 75 | <p>'REGISTER USAGE' REQUIRES A PUBLIC CODE SYMBOL</p> <p>The register usage value must be assigned to a public symbol, which represents a CODE or ECODE symbol.</p> |
| 76 | <p>MULTIPLE REGISTER USES GIVEN TO ONE SYMBOL</p> <p>The register usage value may be assigned to a symbol or procedure only once.</p> |
| 77 | <p>INSTRUCTION NOT AVAILABLE</p> <p>The given instruction is not available in the current mode of operation.</p> |
| 78 | <p>Not generated by Ax51.</p> |
| 79 | <p>INVALID ATTRIBUTE</p> <p>The OVERLAYABLE attribute given in a segment definition is not valid for code and constant segments.</p> |
| 80 | <p>INVALID ABSOLUTE BASE/OFFS VALUE</p> <p>The absolute address given in a segment definition does not conform to the memory type of the segment (for example DATA AT 0x1000).</p> |
| 81 | <p>EXPRESSION HAS DIFFERENT MEMORY SPACE</p> <p>The expression given in a symbol definition statement does not have the memory space required by the directive, for example:</p> <pre>VAR1 CODE EXPR</pre> <p>where 'EXPR' has a memory type other than CODE or NUMBER.</p> |
| 82 | <p>LABEL STATEMENT MUST BE WITHIN CODE/ECODE SEGMENT</p> <p>The LABEL statement is not allowed outside a CODE or ECODE segment.</p> |
| 83 | <p>TYPE INCOMPATIBLE WITH GIVEN MEMORY SPACE</p> <p>The type given in an external declaration is not compatible to the given memory space. The following examples shows an invalid type since a bit can never reside in code space:</p> <pre>EXTRN CODE:BIT (bit0, bit1)</pre> |
| 84 | <p>OPERATOR REQUIRES A CODE/ECODE ADDRESS</p> <p>The type override operators NEAR and FAR cannot be applied to addresses with memory type other than CODE and ECODE.</p> |

| Number | Non-Fatal Error Message and Description |
|--------|---|
| 85 | <p>INVALID OPERAND TYPE</p> <p>An expression contains invalid typed operands to some operator, for example addition/unary minus on bit-type operands.</p> |
| 86 | <p>PROCEDURES CAN'T BE NESTED</p> <p>A251 does not support nested procedures.</p> |
| 87 | <p>UNCLOSED PROCEDURE</p> <p>A251 detected an unclosed procedure after scanning the source file.</p> |
| 88 | <p>VALUE HAS BEEN TRUNCATED TO 16 BITS</p> <p>The displacement value given in a register expression (WRn+disp16, DRk+disp16) has been truncated to 16 bits.</p> |
| 89 | <p>Not generated by Ax51.</p> |
| 90 | <p>'FAR' RETURN IN 'NEAR' PROCEDURE</p> <p>The return far instruction (RET) was encountered in a procedure of type NEAR (the code may not work).</p> |
| 91 | <p>TYPE MISMATCH</p> <p>The operand type of an instruction operand does not match the requested type of the instruction, for example:</p> <p>MOV WR10,Byte_Memory_Operand. ; Word/Byte mismatch</p> <p>Use a type override to avoid the warning as shown:</p> <p>MOV WR10,WORD Byte_Memory_Operand</p> |
| 92, 93 | <p>Not generated by Ax51.</p> |
| 94 | <p>VALUE DOES NOT MATCH INSTRUCTION</p> <p>The short value given in a INC/DEC Rn,#short is not one of 1,2,4.</p> |
| 95 | <p>ILLEGAL MEMORY CLASS SPECIFIER</p> <p>The memory class specifier in a segment definition statement does not correspond to one of the predefined memory class names (CODE, ECODE, BIT, EBIT ...).</p> |
| 96 | <p>ACCESS TO MISALIGNED ADDRESS</p> <p>A word instruction accesses a misaligned (odd) address. This warning is generated only if the \$WORDALIGN control was given.</p> |

| Number | Non–Fatal Error Message and Description |
|-----------|---|
| 97 | 'FAR' REFERENCE TO 'NEAR' LABEL An ECALL/AJMP instruction to some label of type NEAR has been detected. |
| 98 | 'NEAR' REFERENCE TO 'FAR' LABEL An ACALL/AJMP/SJMP or conditional jump instruction to some label of type FAR has been detected. |
| 99 | 'PROC' NAME REQUIRED Ax51 expects the name of the procedure. |
| 100 | ILLEGAL CONSTANT VALUE The constant value is illegal or has an illegal format. |
| 101 | TRAP INSTRUCTION IS RESERVED FOR DEBUGGING TOOLS The TRAP instruction should be used for program debugging only. |
| 102 | PONTENTIAL ADDRESS OVERLAP There is a potential address overlay in your program that is caused by ORG statements. |
| 103 | <user error text> This error is generated by the C preprocessor #error directive or the __ERROR__ directive. |
| 104 - 149 | Not generated by Ax51 . |
| 150 | PREMATURE END OF FILE ENCOUNTERED The MPL macro processor encountered the end of the source file while parsing a macro definition. |
| 151 | <name>: IDENTIFIER EXPECTED The macro or function given by <name> in the error message expected an identifier but found something else. |
| 152 | MPL FUNCTION <name>: <character> EXPECTED The MPL function <name> expected a specific character in the input stream but found some other character. |
| 153 | <name>: UNBALANCED PARENTHESIS While scanning balanced text, the macro processor expected a ')' character, but found some other character. |

| Number | Non-Fatal Error Message and Description |
|--------|--|
| 154 | EXPECTED <identifier> The macro processor expected some specific identifier (for example ELSE) but found some other text. |
| 155 | Not generated by Ax51 . |
| 156 | FUNCTION 'MATCH': ILLEGAL CALL PATTERN The call pattern to the MPL function match must be a formal parameter followed by a delimiter followed by another formal parameter. |
| 157 | FUNCTION 'EXIT' IN BAD CONTEXT The EXIT function must not appear outside a macro expansion, %REPEAT or %WHILE. |
| 158 | ILLEGAL METACHARACTER <character> The metacharacter may not be @, (,), *, TAB, EOL, A-Z,a-z, 0-9, _ and ?. |
| 159 | CALL PATTERN - DELIMITER <delimiter> NOT FOUND The actual parameters in a macro call do not match the call pattern defined in the macro definition of that macro. |
| 160 | CALL TO UNDEFINED MACRO <macroname> An attempt to activate an undefined macro has been encountered . |
| 161 | ERROR-161 Not generated by Ax51 . |
| 162 | INVALID DIGIT 'character' IN NUMBER An ill formed number has been encountered. For numbers, the rules are equal to the numbers in the assembler language with the exception of \$ signs, which are not supported within the MPL. |
| 163 | UNCLOSED STRING OR CHARACTER CONSTANT A string or character constant is terminated by an end of line character instead of the closing character. |
| 164 | INVALID STRING OR CHARACTER CONSTANT A string or character constant may contain one or two characters. |
| 165 | EVAL: UNKNOWN EXPRESSION IDENTIFIER An MPL expression contains an unknown identifier. |

| Number | Non-Fatal Error Message and Description |
|--------|---|
| 166 | <p><token>: INVALID EXPRESSION TOKEN</p> <p>An MPL expression contains a token which neither represents an operator nor an operand.</p> |
| 167 | <p><function>: DIV/MOD BY ZERO</p> <p>The evaluation of an expression within the MPL function <function> yields a division or modulus by zero.</p> |
| 168 | <p>EVAL: SYNTAX ERROR IN EXPRESSION</p> <p>An expression is followed by one or more erroneous tokens.</p> |
| 169 | <p>CAN'T OPEN FILE <name of file></p> <p>The file given in an \$INCLUDE control cannot be opened.</p> |
| 170 | <p><name of file>: IS NOT A DISK FILE</p> <p>An attempt was made to open a file which is not a disk file (for example \$INCLUDE (CON).</p> |
| 171 | <p>ERROR IN INCLUDE DIRECTIVE</p> <p>The argument to the INCLUDE control must be the brace enclosed name of the file, for example \$INCLUDE (REG251.INC).</p> |
| 172 | <p>CAN'T REDEFINE PREDEFINED MACRO 'SET'</p> <p>The .predefined %SET macro can't be redefined.</p> |

Chapter 9. Linker/Locator

9

The **Lx51** linker/locator is used to link or join together object modules that were created using the **Ax51** assembler, the **Cx51** compiler, and the Intel PL/M-51 compiler. Object modules that are created by these translators are relocatable and cannot be directly executed. They must be converted into absolute object modules. The **Lx51** linker/locator does this and much more.

For optimum support of the different 8051 and 251 variants, the following linker/locator variants are available. The **LX51** and **L251** linker/locator provide an improved memory allocation handling and are supersets of the **BL51** linker/locator. The following table gives you an overview of the linker/locator variants along with the translators that are supported.

| Linker/Locator | Processes Files from... | Description |
|---|--|--|
| BL51 Code Banking Linker/Locator | Keil A51 Macro Assembler Keil C51 Compiler Intel ASM51 Assembler Intel PL/M51 Compiler | For classic 8051 . Includes support for 32 x 64KB code banks. |
| LX51 Extended Linker/Locator | Keil A51 Macro Assembler Keil C51 Compiler Keil AX51 Macro Assembler Keil CX51 Compiler for 80C51MX Intel ASM51 Assembler Intel PL/M51 Compiler | For classic 8051 and extended 8051 versions (Philips 80C51MX, Dallas 390, etc.) Allows code and data banking and supports up to 16MB code and xdata memory. |
| L251 Linker/Locator | Keil A51 Macro Assembler Keil C51 Compiler Keil A251 Macro Assembler Keil C251 Compiler Intel ASM51 Assembler Intel PL/M51 Compiler | For Intel/Atmel WM 251. |

Programs you create using the **Ax51** Assembler and the **Cx51** Compiler must be linked using the **Lx51** linker/locator. You cannot execute or simulate programs that are not linked, even if they consist of only one source module. The **Lx51** linker/locator will link one or more object modules together and will resolve references within these modules. This allows you to create a large program that is spread over a number of source files.

The **Lx51** linker/locator provides the following functions:

- Combines several program modules into one module, automatically incorporating modules from the library files
- Combines relocatable partial segments of the same segment name into a single segment
- Allocates and manipulates the necessary memory for the segments with which all relocatable and absolute segments are processed
- Analyzes the program structure and manipulates the data memory using overlay techniques
- Resolves external and public symbols
- Defines absolute addresses and computes the addresses of relocatable segments
- Produces an absolute object file that contains the entire program
- Produces a listing file that contains information about the Link/Locate procedure, the program symbols, and the cross reference of public and external symbol names
- Detects errors found in the invocation line or during the Link/Locate run.
- Supports programs that are larger than 64 Kbytes and applications that are using a Real-Time Multitasking Operating System (RTX51, RTX251, etc.).

All of these operations are described in detail in the remaining sections of this chapter.

“Overview” on page 257 provides you with a summary of the features and capabilities of the **BL51** linker/locator. This chapter introduces the concepts of what a linker is and does.

“Linking Programs” on page 266 describes how to invoke the linker from the command line. The command-line arguments are discussed, and examples are provided.

“Locating Programs to Physical Memory” on page 273 shows how to specify the physical memory available in the target hardware and how to locate segments to specific addresses.

“Data Overlaying” on page 280 explains how the **Lx51** linker/locator creates a call tree for segment overlaying of local variables and discusses how to modify this call tree for applications that use indirect program calls.

“Tips and Tricks for Program Locating” on page 289 shows you several additional features of the Lx51 linker/locator. These features allow you to create in-system programmable applications, to determine the addresses of segments, to use the C251 memory class NCONST without ROM in segment 0, or to locate several segments within a 2KB block.

“Bank Switching” on page 293 describes what bank switching is and how it is implemented by the Lx51 linker/locator. This chapter also shows how to make applications that are larger than 64 KBytes work with code banking.

“Control Summary” on page 305 lists the command-line controls by category and provides you with descriptions of each, along with examples.

“Error Messages” on page 360 lists the errors that you may encounter when you use the Lx51 linker/locator.

Overview

The Lx51 linker/locator takes the object files and library files you specify and generates a absolute object file. Absolute object files can be loaded into debugging tools or may be converted into Intel HEX files for PROM programming by OHx51 Object-Hex Converter.

NOTE

*Banked object files generated by the **BL51** linker/locator must be converted by the **OC51** Banked Object File Converter into absolute object files (one for each bank) before they can be converted into Intel HEX files by the **OH51** Object-Hex Converter.*

While processing object and library files, the Lx51 linker/locator performs the following operations.

9

Combining Program Modules

The object modules that the **Lx51** linker/locator combines are processed in the order in which they are specified on the command line. The **Lx51** linker/locator processes the contents of object modules created with the **Ax51** assembler or the **Cx51** compiler. Library files, however, contain a number of different object modules; and, only the object modules in the library file that specifically resolve external references are processed by the **Lx51** linker/locator.

Segment Naming Conventions

Objects generated by the **Cx51** and Intel PL/M-51 compilers are stored in segments, which are units of code or data memory. A segment may be relocatable or may be absolute. Each relocatable segment has a type and a name. This section describes the conventions used for naming these segments.

Segment names include a *module_name*. The *module_name* is the name of the source file in which the object is declared and excludes the drive letter, path specification, and file extension. In order to accommodate a wide variety of existing software and hardware tools, all segment names are converted and stored in uppercase.

Each segment name has a prefix (or in case of PL/M-51 a postfix) that corresponds to the memory type used for the segment. The prefix is enclosed in question marks (?). The following is a list of the standard segment name prefixes.

| Segment Prefix | Memory Class | Description |
|----------------|--------------|--|
| ?PR? | CODE | Executable program code |
| ?CO? | CONST | Constant data in program memory |
| ?ED? | EDATA | EDATA memory for near variables |
| ?FD? | HDATA | HDATA memory for far variables |
| ?XD? | XDATA | XDATA memory |
| ?DT? | DATA | DATA memory |
| ?ID? | IDATA | IDATA memory |
| ?BI? | BIT | Bit data in internal data memory |
| ?BA? | DATA | Bit-addressable data in internal data memory |
| ?PD? | XDATA | Paged data in XDATA memory |

For detailed information about the segment naming conventions refer to the Cx51 Compiler User's Guide.

Combining Segments

A segment is a code or data block that is created by the compiler or assembler from your source code. There are two basic types of segments: absolute and relocatable. Absolute segments reside in a fixed memory location. They cannot be moved by the linker. Absolute segments do not have a segment name and will not be combined with other segments. Relocatable segments have a name and a type (as well as other attributes shown in the table below). Relocatable segments with the same name but from different object modules are considered parts of the same segment and are called partial segments. The linker/locator combines these partial relocatable segments.

The following table lists the segment attributes that are used to determine how to link, combine, and locate code or data in the segment.

| Attribute | Description |
|------------------------|---|
| Name | Each relocatable segment has a name that is used when combining relocatable segments from different program modules. Absolute segments do not have names. |
| Memory Class | The memory class identifies the address space to which the segment belongs. For BL51 the type can be CODE, XDATA, DATA, IDATA, or BIT. LX51 and L251 support in addition CONST, EBIT, ECONST, EDATA, HDATA, HCODE, HCONST, and user-define memory classes. |
| Relocation Type | The relocation type specifies the relocation operations that can be performed by the linker/locator. Valid relocation types are AT <i>address</i> , BITADDRESSABLE, INBLOCK, INPAGE, INSEG, OFFS <i>offset</i> , and OVERLAYABLE. |
| Alignment Type | The alignment type specifies the alignment operations that can be performed by the linker/locator. Valid alignment types are BIT, BYTE, WORD, DWORD, PAGE, BLOCK, and SEG. |
| Length | The length attribute specifies the length of the segment. |
| Base Address | The base address specifies the first assigned address of the segment. For absolute segments, the address is assigned by the assembler. For relocatable segments, the address is assigned by the linker/locator. |

While processing your program modules, the linker/locator produces a table or map of all segments. The table contains name, type, location method, length, and base address of each segment. This table aids in combining partial relocatable segments. All partial segments having the same name are combined by the linker/locator into one single relocatable segment.

9

The linker/locator uses the following rules when combining partial segments.

- All partial segments that share a common name must have the same memory class. An error occurs if the types do not correspond.
- The length of the combined segments must not exceed the length of the physical memory area.
- The location method for each of the combined partial segments must correspond.

Absolute segments are not combined with other absolute segments, they are copied directly to the output file.

Locating Segments

After the linker/locator combines partial segments it must determine a physical address for them. The linker/locator processes each memory class separately. Refer to “Memory Classes and Memory Layout” on page 27 for a discussion of the different memory class and the physical address ranges.

After the linker/locator combines partial segments, it must determine a physical address for them. The linker/locator places different segments in each of these memory areas. The memory is allocated in the following order:

1. Register Banks and segments with an absolute address.
2. Segments specified in **Lx51** segment allocation controls.
3. Segments with the relocation type BITADDRESSABLE and other BIT segments.
4. All other segments with the memory class DATA.
5. Segments with the memory class IDATA, EDATA and NCONST.
6. Segments with the memory class XDATA.
7. Segments with the memory class CODE and the relocation type INBLOCK.
8. Other Segments with the memory class CODE and CONST.
9. Segments with the memory classes ECODE, HCONST, and HDATA.

Overlaying Data Memory

The stack addressing of the **x51** CPU is slower compared to accessing fixed, absolute memory locations. For this reason, local variables and function arguments of C and PL/M-51 routines are stored at fixed memory locations rather than on the stack. By using techniques to overlay the parameters and local variables of C and PL/M-51 functions, the linker/locator attempts to maximize the amount of available space.

NOTE

*The **Cx51** compiler supports also reentrant functions where the parameters and automatic variables are store on the CPU stack of a simulate stack. For detailed information refer to the **Cx51** User's Guides.*

To accomplish overlaying, the linker/locator analyzes all references or calls between the various functions. Using this information, the linker/locator can determine precisely which data and bit segments can be overlaid.

You may use the **OVERLAY** and **NOOVERLAY** control to enable or disable data overlaying. The **OVERLAY** control is the default and allows for very compact data areas. Use the **NOOVERLAY** control to disable the segment overlay function.

Resolving External References

External symbols reference addresses in other modules. A declared external symbol must be resolved with a public symbol of the same name. Therefore, for each external symbol, a public symbol must exist in another module.

The linker/locator builds a table of all public and external symbols that it encounters. External references are resolved with public references as long as the names match and the symbol attributes correspond.

The linker/locator reports an error if the symbol types of an external and public symbol do not correspond. The linker/locator also reports an error if no public symbol is found for an external reference.

The absolute addresses of the public symbols are resolved after the location of the segments is determined.

9

Absolute Address Calculation

After the segments are assigned fixed memory locations and external and public references are processed, the linker/locator calculates the absolute addresses of the relocatable addresses and external addresses. Symbolic debugging information is also updated to reflect the new addresses.

Generating an Absolute Object File

The linker/locator generates the executable target program in absolute object module format. The generated object module may contain debugging information if the linker/locator is so directed. This information facilitates symbolic debugging and testing. You may use the linker controls to suppress debugging information in the object file.

The output file generated by the linker/locator may be loaded into the μ Vision2 debugger, in-circuit emulators, or may be translated into an Intel HEX file for use with an EPROM programmer. The following table provides an overview of the output format and the processing method for the different linker/locator variants.

| Linker/Locator | Output Format | Description |
|-------------------------------------|---|--|
| BL51 Linker/Locator | Extended Intel OMF51 <i>or</i> Banked OMF51 | Intel OMF51 is the standard format for programming the 8051 and supported by virtually all emulator vendors. Extensions in this format provide symbolic information. For banked applications the BL51 Linker/Locator generates a banked OMF51 file that can be converted with the OC51 Object File Converter into standard OMF51 files. The OC51 step is also required to convert the file into an Intel HEX file. |
| LX51 Extended Linker/Locator | Keil OMFx51 | The Keil OMFx51 format supports up to 16MB code and xdata memory. This format is required for extended 8051 versions (Philips 80C51MX , Dallas 390 , etc.). Check with your emulator vendor if this format is supported. |
| L251 Linker/Locator | Intel OMF251 | Intel OMF251 is the standard format for programming the 251 and supported by all 251 emulator vendors. |

Generating a Listing File

9

The linker/locator generates a listing file that lists information about each step in the link and locate process. This file also contains information about the symbols and segments involved in the linkage. In addition, the following information may be found in the listing file:

- The filenames and other parameters specified on the command line.
- Filenames and module names of all processed modules.
- A memory allocation table, which contains the location of the segments, the segment type, the location method, and the segment name. This table may be suppressed by specifying the **NOMAP** control.
- The overlay map which shows the structure of the finished program and lists address information for the local data and bit segments of a function. The overlay map also lists all code segments for which **OVERLAYABLE** segments exist. You may suppress the overlay map by specifying the **NOMAP** control.
- **LX51** and **L251** provide a list of all **PUBLIC** symbols within a program.
- A list of all errors in segments and symbols. The error causes are listed at the end of the listing file.
- A list of all unresolved external symbols. An external symbol is unresolved if no corresponding public symbol exists in another input file. Each reference to an unresolved external symbol is listed in an error message at the end of the listing file.
- A symbol table, which contains the symbol information from the input files. This information consists of the names of the **MODULES**, **SYMBOLS**, **PUBLICS**, and **LINES**. You may selectively suppress the symbolic information with linker controls.
- An alphabetically sorted cross reference report of all **PUBLIC** and **EXTERN** symbols in which the memory type and the module names that contain a reference to that symbol are displayed.
- Errors detected during the execution of the linker/locator are displayed on the screen as well as at the end of the listing file. Refer to “Error Messages” on page 360 for a summary of the linker/locator errors and causes.

9

Bank Switching

The classic 8051 directly supports a maximum of 64 KBytes of code space. The **Lx51** linker/locator allows 8051 programs to be created that are larger than 64 KBytes by using a technique known as code banking or bank switching. Bank switching involves using extra hardware to select one of a number of code banks all of which will reside at a common physical address.

For example, your hardware design may include a ROM mapped from address 0000h to 7FFFh (known as the common area) and four 32K ROM blocks mapped from code address 8000h to 0FFFFh (known as the code bank area). The following figure shows the memory structure.

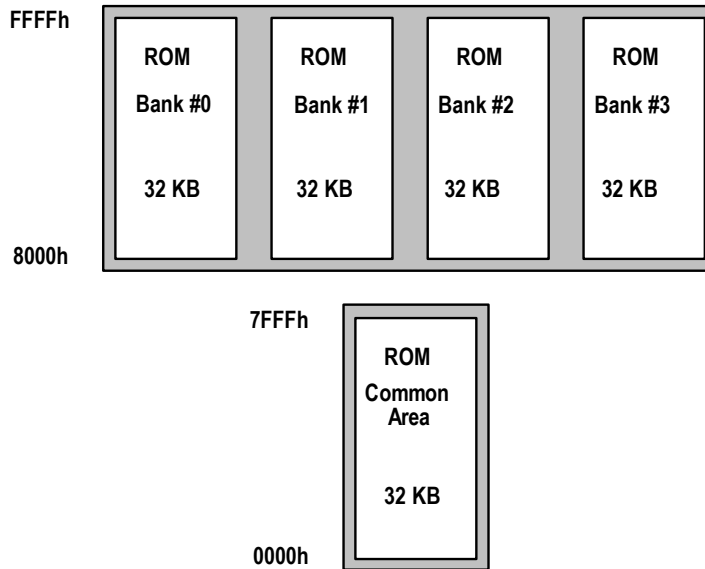

The code banking facility of **Lx51** is compatible with the **C51** compiler, the **CX51** compiler, and the Intel **PL/M-51** compiler. Modules written using one of these compilers can be easily used in code banking applications. No modifications to the original source files are required.

Refer to “Bank Switching” on page 293 for detailed information about memory banking and instructions for building code banking programs.

Using RTX51, RTX251, and RTX51 Tiny

Programs you create that utilize the RTX51, and RTX51 Tiny Real-Time Operating Systems must be linked using the **BL51** or the **LX51** linker/locator. The **RTX51** and **RTX51TINY** controls enable link-time options that are required to generate RTX51 Full and RTX51 Tiny applications.

Programs that use the RTX251 Full Real-Time Operating Systems must be linked using the **L251** linker/locator. The **RTX251** control enable link-time options that are required to generate RTX251 Full applications.

9

Linking Programs

The **Lx51** linker/locator is invoked by typing the program name at the Windows command prompt. On this command line, you must include the name of the assembler source file to be translated, as well as any other necessary assembler controls required to translate your source file. The format for the **Lx51** command line is:

```
BL51 [inputlist] [TO outputfile] [controls]
LX51 [inputlist] [TO outputfile] [controls]
L251 [inputlist] [TO outputfile] [controls]
```

or

```
BL51 @commandfile
LX51 @commandfile
L251 @commandfile
```

where

- inputlist*** is a list of the object files, separated by commas, for the linker/locator to include in the *outputfile*. The *inputlist* can contain files from **Ax51**, **Cx51**, **PL/M-51** and library files. For library files you may force the inclusion of modules by specifying the module names in parentheses. The format of the *inputlist* is described below.
- outputfile*** is the name of the absolute object file that the linker/locator creates. If no *outputfile* is specified on the command line, the first filename in the input list is used. The basename of the *outputfile* is also the default name for the map file.
- controls*** are commands and parameters that control the operation of the **Lx51** linker/locator.
- commandfile*** is the name of a command input file that may contain an *inputlist*, *outputfile*, and *controls*. The text in a *commandfile* has the same format as the standard command line and is produced by any standard ASCII text editor. Newline characters and comments a *commandfile* are ignored. **Lx51** interprets the first filename preceded by an at sign (@) as a *commandfile*.

The *inputlist* uses the following general format:

```
filename [(modulename [, ...]) [, ...]
```

where

filename is the name of an object file created by **Ax51**, **Cx51**, or Intel **PL/M-51** or a library file created by the **LIBx51** library manager. The *filename* must be specified with its file extension. Object files use the extension **.OBJ**. Library files use the extension **.LIB**.

modulename is the name of an object module in the library file. The *modulename* may only be used after the name of a library file. The *modulenames* must be specified in parentheses after the filename. Multiple *modulenames* may be separated by commas.

9

Command Line Examples

The following examples are proper command lines for the **Lx51** linker/locator.

```
BL51 C:\MYDIR\PROG.OBJ TO C:\MYDIR\PROG.ABS
```

In this example, only the input file, `C:\MYDIR\PROG.OBJ`, is processed and the absolute object file generated is stored in the output file `C:\MYDIR\PROG.ABS`.

```
LX51 SAMPLE1.OBJ, SAMPLE2.OBJ, SAMPLE3.OBJ TO SAMPLE.ABS
```

In this example, the files `SAMPLE1.OBJ`, `SAMPLE2.OBJ`, and `SAMPLE3.OBJ` are linked and absolute object file that is generated is stored in the file `SAMPLE.ABS`.

```
L251 PROG1.OBJ, PROG2.OBJ, UTILITY.LIB
```

In this example, unresolved external symbols are resolved with the public symbols from the library file `UTILITY.LIB`. The modules required from the library are linked automatically. Modules from the library that are not referenced are not included in the generated absolute object file.

```
BL51 PROG1.OBJ, PROG2.OBJ, UTILITY.LIB (FPMUL, FPDIV)
```

In this example, unresolved external symbols are resolved with the public symbols from the library file `UTILITY.LIB`. The modules required from the library are linked automatically. In addition, the `FPMUL` and `FPDIV` modules are included whether they are needed or not. Other modules from the library that are not referenced are not included in the generated absolute object file.

```
LX51 @PROJECT.LIN
```

Content of the file `PROJECT.LIN`:

```
PROG1.OBJ,          /* Program Module 1 */
PROG2.OBJ,          // program module 2
UTILITY.LIB (FPMUL, FPDIV) ; include always FPMUL and FPDIV
```

This is example is the same as the example before, but uses a command input file that includes comments.

Control Linker Input with μ Vision2

The C and assembler source files that are part of a μ Vision2 project are translated when you build your application. The object files generated are then supplied as linker input file by the μ Vision2 build process. However you may also include object and library files as part of a μ Vision2 project in the same way as you include source files. You may set additional linker options for a file or file group using the **Options – Properties** dialog. For detailed information refer to the *Getting Started and Creating Applications User's Guide*.

ERRORLEVEL

After linking, the **Lx51** linker/locator sets the **ERRORLEVEL** to indicate the status of the linking process. The **Lx51** linker/locator and the other utilities generate the same **ERRORLEVEL** values as the **Ax51** macro assembler. Refer to “ERRORLEVEL” on page 197 for more information.

Output File

The **Lx51** linker/locator creates an output file using the input object files that you specify on the command line. The output file is an absolute object file that may be loaded into debugging tools like the μ Vision2 Debugger or may be converted into a Intel HEX for PROM programming.

9

Linker/Locator Controls

Controls for the **Lx51** linker/locator may be entered after the output file specification. Multiple controls must be separated by at least one space character (). Each control may be entered only once on the command line. If a control is entered twice, the **Lx51** linker/locator reports an error.

The following table lists all **Lx51** linker/locator controls and a brief description. The controls of the **BL51** linker/locator are listed in the first table. The controls of the extended **LX51** linker/locator and **L251** linker/locator are listed in the second table. **LX51** and **L251** provide the same sets of controls.

The “Control Summary” on page 305 explains the command-line controls in detail. Refer to page number provided in the tables for quick reference to descriptions and examples for each control.

NOTE

Underlined characters denote the abbreviation for the particular control.

BL51 Controls

| Controls | Page | Description |
|--------------------------------|------|--|
| <u>B</u>ANKAREA | 332 | Specifies the address range where the code banks are located. |
| <u>B</u>ANKx | 333 | Specifies the start address and segments for code banks. |
| <u>B</u>IT | 334 | Locates and orders BIT segments. |
| <u>C</u>ODE | 338 | Locates and orders CODE segments. |
| <u>D</u>ATA | 339 | Locates and orders DATA segments. |
| <u>D</u>ISABLEWARNING | 307 | Disables specified warning messages. |
| <u>I</u>BANKING | 323 | Generate bank switch code for Infineon TV TEXT devices. |
| <u>I</u>DATA | 340 | Locates and orders IDATA segments. |
| <u>I</u>XREF | 308 | Includes a cross reference report in the listing file. |
| <u>N</u>AME | 323 | Specifies a module name for the object file. |
| <u>N</u>OAJMP | 325 | Generate bank switch code without AJMP instructions. |
| <u>N</u>ODEBUGLINES | 325 | Excludes line number information from the object file. |
| <u>N</u>ODEBUGPUBLICS | 325 | Excludes public symbol information from the object file. |
| <u>N</u>ODEBUGSYMBOLS | 325 | Excludes local symbol information from the object file. |
| <u>N</u>ODEFAULTLIBRARY | 352 | Excludes modules from the run-time libraries. |
| <u>N</u>OINDIRECTCALL | 327 | Do not generate bank switch code for indirectly called functions. |
| <u>N</u>OJMPTAB | 328 | Do not generate bank switch code. |
| <u>N</u>OLINES | 310 | Excludes line number information from the listing file. |
| <u>N</u>OMAP | 311 | Excludes memory map information from the listing file. |
| <u>N</u>OOVERLAY | 353 | Prevents overlaying or overlapping local bit and data segments. |
| <u>N</u>OPRINT | 315 | Disables generation of a listing file. |
| <u>N</u>OPUBLICS | 312 | Excludes public symbol information from the listing file. |
| <u>N</u>OSORTSIZE | 341 | Disable size sorting for segments before allocating the memory. |
| <u>N</u>OSYMBOLS | 313 | Excludes local symbol information from the listing file. |
| <u>O</u>VERLAY | 354 | Modifies call tree for data overlaying of local data & bit segments. |
| <u>P</u>AGELNGTH | 314 | Sets maximum number of lines in each page of listing file. |
| <u>P</u>AGewidth | 314 | Sets maximum number of characters in each line of listing file. |
| <u>P</u>DATA | 341 | Specifies the starting address for PDATA segments. |
| <u>P</u>RECEDE | 343 | Locates segments that precede others in the DATA memory. |
| <u>P</u>RINT | 315 | Specifies the name of the listing file. |
| <u>R</u>AMSIZE | 344 | Specifies the size of the on-chip data memory. |
| <u>R</u>ECURSIONS | 356 | Allows analyze of the call tree of complex recursive applications. |
| <u>R</u>EGFILE | 356 | Specifies the register usage information file generated by Lx51. |
| <u>R</u>TX51 | 358 | Includes support for the RTX-51 full real-time kernel. |
| <u>R</u>TX51TINY | 358 | Includes support for the RTX-51 tiny real-time kernel. |
| <u>S</u>PEEDOVL | 359 | Ignore during overlay analysis references from constant segments. |
| <u>S</u>TACK | 349 | Locates and orders STACK segments. |
| <u>X</u>DATA | 350 | Locates and orders XDATA segments. |

9

LX51 and L251 Controls

| Controls | Page | Description |
|--------------------------------|------|--|
| <u>ASSIGN</u> | 322 | Defines public symbols on the command line. |
| <u>BANKAREA</u> | 332 | Specifies the address range where the code banks are located. |
| <u>CLASSES</u> | 336 | Specifies a physical address range for segments in a memory class. |
| <u>DISABLEWARNING</u> | 307 | Disables specified warning messages. |
| <u>IXREF</u> | 308 | Includes a cross reference report in the listing file. |
| <u>NAME</u> | 323 | Specifies a module name for the object file. |
| <u>NOAJMP</u> | 325 | Generate bank switch code without AJMP instructions. |
| <u>NOCOMMENTS</u> | 309 | Excludes comment information from listing file and the object file. |
| <u>NODEFAULTLIBRARY</u> | 352 | Excludes modules from the run-time libraries. |
| <u>NOINDIRECTCALL</u> | 327 | Do not generate bank switch code for indirectly called functions. |
| <u>NOLINES</u> | 310 | Excludes line number information from listing file and object file. |
| <u>NOMAP</u> | 311 | Excludes memory map information from the listing file. |
| <u>NOOVERLAY</u> | 353 | Prevents overlaying or overlapping local bit and data segments. |
| <u>NOPRINT</u> | 315 | Disables generation of a listing file. |
| <u>NOPUBLICS</u> | 312 | Excludes public symbol information from the listing and object file. |
| <u>NO SYMBOLS</u> | 313 | Excludes local symbol information from the listing file. |
| <u>NOSORTSIZE</u> | 341 | Disable size sorting for segments before allocating the memory. |
| <u>NOTYPE</u> | 327 | Excludes type information from the listing file and the object file. |
| <u>OBJECTCONTROLS</u> | 330 | Excludes specific debugging information from the object file. |
| <u>OVERLAY</u> | 354 | Modifies call tree for data overlaying of local data & bit segments. |
| <u>PAGELLENGTH</u> | 314 | Sets maximum number of lines in each page of listing file. |
| <u>PAGEWIDTH</u> | 314 | Sets maximum number of characters in each line of listing file. |
| <u>PRINT</u> | 315 | Specifies the name of the listing file. |
| <u>PRINTCONTROLS</u> | 316 | Excludes specific debugging information from the listing file. |
| <u>PURGE</u> | 317 | Excludes all debugging information from the listing and object file. |
| <u>RECURSIONS</u> | 356 | Allows analyze the call tree of complex recursive applications. |
| <u>REGFILE</u> | 356 | Specifies the register usage information file generated by Lx51. |
| <u>RESERVE</u> | 345 | Reserves memory and prevent Lx51 from using memory areas. |
| <u>RTX251</u> | 358 | Includes support for the RTX-251 full real-time kernel. |
| <u>RTX51</u> | 358 | Includes support for the RTX-51 full real-time kernel. |
| <u>RTX51TINY</u> | 358 | Includes support for the RTX-51 tiny real-time kernel. |
| <u>SEGMENTS</u> | 346 | Defines physical memory addresses and orders for segments. |
| <u>SEGSIZE</u> | 348 | Specifies memory space used by a segment. |
| <u>WARNINGLEVEL</u> | 318 | Controls the types and severity of warnings generated. |

Locating Programs to Physical Memory

9

This section describes with examples how you locate your application into the physical memory space for the different **x51** variants. Refer to “Segment and Memory Location Controls” on page 331 for a detailed description of the linker/locator controls used in the examples below.

The linker/locator determines the physical memory range for relocatable segments based on the memory class that is assigned to the segment. Refer to “Memory Classes and Memory Layout” on page 27 for more information. However, it is also possible to specify a fixed address for a segment using linker/locator controls.

Classic 8051

The classic 8051 provides three different memory areas: on-chip RAM that covers the DATA, BIT and IDATA memory, XDATA memory, and CODE memory. The “Classic 8051 Memory Layout” is shown on page 29.

9

Classic 8051 without Code Banking

The following examples illustrate how to setup the linker/locator. For the BL51 linker/locator the physical memory is defined with the **RAMSIZE**, **XDATA** and **CODE** control. For the LX51 linker/locator the **CLASSES** control is used to specify the available physical memory.

The following example assumes the following memory areas.

| Memory Type | Address Range | Used by |
|--------------------|--|----------------------------------|
| ON-CHIP RAM | D:0 – D:0x7F (128 Bytes) | registers, bits, variables, etc. |
| XDATA RAM | X:0 – X:0x7FFF, X:0xF800 – X:0xFFFF | space for variables. |
| CODE ROM | C:0 – C:0x7FFF | program code and constant area. |

To specify this memory layout BL51 should be invoked with as follows:

```
BL51 PROG.OBJ XDATA (0-0x7FFF, 0xF800-0xFFFF) CODE (0-0x7FFF) RAMSIZE(128)
```

You may also use the LX51 linker/locator. The **CLASSES** directive should have the following settings:

```
LX51 PROG.OBJ CLASSES (IDATA (D:0-D:0x7F),
                      XDATA (X:0-X:0x7FFF, X:0xF800-X:0xFFFF),
                      CODE (C:0-C:0x7FFF))
```

NOTE

You need not to define the address range for the memory classes DATA and BIT since the LX51 default setting already covers the correct physical address range.

Classic 8051 with Code Banking

The following example uses classic 8051 with a code banking hardware. This hardware has the following memory resources:

| Memory Type | Address Range | Used by |
|-------------|--|----------------------------------|
| ON-CHIP RAM | I:0 – I:0xFF (256 Bytes) | registers, bits, variables, etc. |
| XDATA RAM | X:0 – X:0xEFFF | space for variables. |
| CODE ROM | C:0 – C:0x7FFF (common area) B0:0x8000 – B3:0xFFFF (four banks) | program code and constant area. |

Parts of your program will be located into banks using **BANKx** in the *inputlist* portion of the **Lx51** linker/locater command-line. Refer to “Bank Switching” on page 293 for more information. In addition you must specify the size of the common area and the other memory resources of your hardware. For this memory layout, the BL51 linker/locater should be invoked with as follows:

```
BL51 BANK0 {A.OBJ}, BANK1 {B.OBJ}, BANK2 {C.OBJ}, BANK3 {D.OBJ}
      XDATA (0-0xEFFF) BANKAREA (0x8000 - 0xFFFF) RAMSIZE(256)
```

The LX51 linker/locater needs to be invoked as follows:

```
LX51 BANK0 {A.OBJ}, BANK1 {B.OBJ}, BANK2 {C.OBJ}, BANK3 {D.OBJ}
      CLASSES (IDATA (I:0-I:0xFF), XDATA (X:0-X:0xEFFF),
              CODE (C:0-C:0xFFFF)) BANKAREA (0x8000-0xFFFF)
```

9

Extended 8051 Variants

Some extended 8051 variants expand the external data and program memory to up to 16MB. The additional memory space is addressed with the memory classes HDATA and HCONST. The “Extended 8051 Memory Layout” is shown on page 31. Only the LX51 linker/locator supports this expanded memory space. The following example shows assumes the following memory areas.

| Memory Type | Address Range | Used by |
|-------------|--------------------------|---------------------------------|
| ON-CHIP RAM | D:0 – D:0xFF (256 Bytes) | registers, bits, variables. |
| XDATA RAM | X:0 – X:0x1FFFF (128 KB) | space for variables. |
| CODE ROM | C:0 – C:0xFFFF (1 MB) | program code and constant area. |

To specify this memory layout LX51 should be invoked with the following CLASSES directive.

```
LX51 MYPROG.OBJ CLASSES (HDATA (X:0 - X:0x1FFFF),
                        HCONST (C:0 - C:0xFFFF))
```

NOTE

You need not to define the address range for the memory classes DATA, IDATA, BIT, CODE, CONST, and XDATA since the LX51 default already covers the correct physical address ranges for these memory classes.

The memory classes HDATA and HCONST are used for constants or variables only. Program code is located into the expanded program memory with the same code banking mechanism as described above under “Classic 8051 with Code Banking”. A command line example that locates also program code into the expanded program memory will look as follows:

```
LX51 BANK0 {A.OBJ}, BANK1 {B.OBJ}, BANK2 {C.OBJ}, BANK3 {D.OBJ}
    CLASSES (IDATA (I:0-I:0xFF), XDATA (X:0-X:0xEFFF),
            HDATA (X:0-X:0x1FFFF), HCONST (C:0-C:0xFFFF))
    CODE (C:0-C:0xFFFF) BANKAREA (0x8000-0xFFFF)
```

There are several *Keil Application Notes* available that show how to create programs for extended 8051 devices. Check www.keil.com or the Keil development tools CD-ROM for *Keil Application Notes* that explain how to setup the tools for extended 8051 devices.

Philips 80C51MX

The Philips 80C51MX has a linear 16MB address space that includes the standard 8051 memory areas DATA/IDATA, CODE, and XDATA. In addition both the external data space and the program space can be up to 8 MB. The “80C51MX Memory Layout” is shown on page 33. The LX51 linker/locater is used for the Philips 80C51MX microcontroller family. The following example shows assumes the following memory areas.

| Memory Type | Address Range | Used by |
|-------------|----------------------|---------------------------------|
| ON-CHIP RAM | 7F:0000H .. 7F:03FFH | registers, bits, variables. |
| RAM | 00:0000H .. 01:FFFFH | EDATA space for variables. |
| ROM | 80:0000H .. 83:FFFFH | program code and constant area. |

To specify this memory layout LX51 should be invoked with the following CLASSES directive.

```
LX51 MYPROG.OBJ CLASSES (HDATA (0 - 0x1FFFF),
                        EDATA (0x7F0000 - 0x7F03FF),
                        ECODE (0x800000 - 0x83FFFF),
                        HCONST (0x800000 - 0x83FFFF))
```

NOTE

You need not to define the address range for the memory classes DATA, IDATA, BIT, CODE, CONST, and XDATA since the LX51 default already covers the correct physical address ranges for these memory classes.

In the AX51 assembler it is possible to use the ECODE class and therefore the complete 8MB code address space for program code. However, the CX51 compiler uses code banks to allocate parts of your program into the extended program memory. Therefore you must use same technique as described above under “Classic 8051 with Code Banking” to locate parts of your program into the ECODE space. A command line example will look as follows:

```
LX51 BANK0 {A.OBJ}, BANK1 {B.OBJ}, BANK2 {C.OBJ}, BANK3 {D.OBJ}
CLASSES (HDATA (0 - 0x1FFFF), EDATA (0x7F0000 - 0x7F03FF),
        ECODE (0x800000 - 0x83FFFF), HCONST (0x800000 - 0x83FFFF))
```

Intel/Atmel WM 251

The Intel/Atmel WM 251 has like the Philips 80C51MX a linear 16MB address space that includes all the memory classes. The “251 Memory Layout” is shown on page 35. The following examples show you the invocation of the L251 linker/locator that is used for the Intel/Atmel WM 251 microcontroller family.

Example 1: The following example assumes the following memory areas.

| Memory Type | Address Range | Used by |
|-------------|----------------------|---------------------------------|
| ON-CHIP RAM | 00:0000H .. 00:041FH | registers, bits, variables. |
| RAM | 00:8000H .. 00:FFFFH | EDATA space for variables. |
| ROM | FF:0000H .. FF:7FFFH | program code and constant area. |

To specify this memory layout L251 should be invoked with the following CLASSES directive.

```
L251 MYPROG.OBJ CLASSES (EDATA (0 - 0x41F, 0x8000 - 0xFFFF),
                        CODE (0xFF0000 - 0xFF7FFF),
                        CONST (0xFF0000 - 0xFF7FFF))
```

NOTES

You need not to define the address range for the memory classes DATA, IDATA, BIT and EBIT since the L251 default already covers the correct physical address ranges for these memory classes.

This example assumes that the memory classes XDATA, HDATA, HCONST, HCODE, and NCONST are not used in your application.

Example 2: In addition to the example above, the next system contains a third RAM for the memory class XDATA. In addition the ROM space is increased.

| Memory Type | Address Range | Used by |
|-------------|----------------------|----------------------------------|
| ON-CHIP RAM | 00:0000H .. 00:041FH | registers, bits, variables. |
| ROM | 00:0420H .. 00:7FFFH | NCONST space. |
| RAM | 00:8000H .. 01:7FFFH | EDATA/HDATA space for variables. |
| ROM | FE:0000H .. FF:FFFFH | program code and constant area. |

To specify this memory layout L251 should be invoked with the following CLASSES directive.

```
L251 MYPROG.OBJ CLASSES (EDATA (0 - 0x41F, 0x8000 - 0xFFFF),
                          NCONST (0x420 - 0x7FFF),
                          HDATA (0x8000-0x1FFFF),
                          HCONST (0xFE0000 - 0xFFFFFFF),
                          ECODE (0xFE0000 - 0xFFFFFFF))
```

NOTE

You need not to define the address range for the memory classes DATA, IDATA, BIT, EBIT, CODE, CONST, and XDATA since the L251 default already covers the correct physical address ranges for these memory classes.

9

Data Overlaying

Because of the limited amount of stack space available on the **x51**, local variables and function arguments of C and PL/M-51 routines are stored at fixed memory locations rather than on the stack. Normally, the **Lx51** linker/locator analyses the program structure of your application, creates a call tree and overlays the data segments that contain local variables and function arguments.

This technique usually works very well and provides the same efficient use of memory than a conventional stack frame would. Therefore this technique is also known as *compiled-time* stack since the stack layout is fixed during the Compiler and Linker run. However, in certain situations, this can be undesirable. You may use the **NOOVERLAY** control to disable overlay analysis and data overlaying. Refer to “NOOVERLAY” on page 353 for more information about this control.

By default, the **Lx51** linker/locator overlays the memory areas for local variables and function arguments with the same memory areas of other functions, provided that the functions do not call each other. Therefore the **Lx51** linker/locator analyses the program structure and creates a function call tree.

The local data and bit segments that belong to a function are determined by their segment names. The local data and bit segments of a function are overlaid with other function’s data and bit segments under the following conditions:

- No call references may exist between the functions. The **Lx51** linker/locator considers direct calls between functions, as well as calls via other functions.
- The functions may be invoked by only one program event: main or interrupt. It is not possible to overlay data areas if a function is called by an interrupt and during the main program. The same is true when the function is called by several interrupts that might be nested.
- The segment definitions must conform to the rules described below.

NOTE

*Typically, the **Lx51** linker/locator generates overlay information that is accurate. However, in some instances the default analysis of the call tree is ineffective or incorrect. This occurs with indirectly called functions through function pointers and functions that are called by both the main program and an interrupt function.*

Program and Data Segments of Functions

For correct data overlaying the **Lx51** linker/locator must know the function code and the local variable space that belongs to this function. The program and data segments that belong together are determined by standard segment naming convention used by the **Cx51** compiler and PL/M-51 compiler. Therefore, segments used in assembler programs should be constructed according to the following rules.

| Segment Content | Cx51 Segment Name | PL/M-51 Segment Name |
|-------------------|-----------------------------|----------------------|
| Program CODE | ?PR?functionname?modulename | ?modulename?PR |
| Local BIT space | ?BI?functionname?modulename | ?modulename?BI |
| Local DATA space | ?DT?functionname?modulename | ?modulename?DT |
| Local IDATA space | ?ID?functionname?modulename | — |
| Local XDATA space | ?XD?functionname?modulename | — |
| Local PDATA space | ?PD?functionname?modulename | — |
| Local EDATA space | ?ED?functionname?modulename | — |
| Local EBIT space | ?EB?functionname?modulename | — |
| Local HDATA space | ?HD?functionname?modulename | — |

?PR?, ?BI?, ?DT?, ?XD?, ?ID?, ?PD?, ?ED?, ?EB?, and ?HD? is derived from the memory class.

In addition each bit and data segment must have the relocation type OVERLAYABLE.

The **Cx51** compiler and PL/M-51 compiler define automatically local data segments according to these rules. However, if you use overlayable segments in your assembly modules, you must follow these naming conventions. Refer to “SEGMENT” on page 106 for information on how to declare segments.

Example for Segment declaration in assembly language:

```
?PR?func1?module1 SEGMENT CODE           ; segment for func1 code
?DT?func1?module1 SEGMENT DATA OVERLAYABLE ; data segment belongs to func1

func1_var:          RSEG ?DT?func1?module1
                   DS   10      ; space for local variables in func1

func1:              RSEG ?PR?func1?module1
                   MOV  func1_var,A
                   RET
```

More information can be found in the *Keil Application Note 149: Data Overlaying and Code Banking with Assembler Modules* that is available on www.keil.com or the Keil development tools CD-ROM.

9

Using the Overlay Control

In most cases, the **Lx51** data overlay algorithm works correct and does not require any adjustments. However, in some instances the overlay algorithm cannot determine the *real* structure of your program and you must adjust the function call tree with the **OVERLAY** control. This is the case when your program uses function pointers or contains virtual program jumps as it is the case in the scheduler of a real-time operating system.

NOTE

*The **Lx51** linker/locator recognizes correctly the program structure and the call tree of applications that are using the RTXx51 real-time operating system. You need not to use the **OVERLAY** control to specify the task functions of the RTXx51 application, since this is automatically performed by the **Lx51** linker/locator.*

The **OVERLAY** control allows you to change the call references used by the **Lx51** linker/locator during the overlay analysis. Using the **OVERLAY** control is easy when you know the structure of your program. The program structure or call tree is reflected in the segments listed in the **OVERLAY MAP** of the listing file created by the **Lx51** linker/locator.

The following application examples show situations where the **OVERLAY** control is required to correct the call tree. In general, a modification of the references (calls) is required in the following cases:

- When a pointer to a function is passed or returned as function argument.
- When a pointer to a function is contained in initialized variables.
- When your program includes a real-time operating system.

Disable Data Overlaying

If you are in doubt about whether certain segments should be overlaid or not, you may disable overlaying of those segments. Segment overlaying can be disabled at **Cx51** compiler level or with the **OVERLAY** control at the **Lx51** linker/locator command line as follows:

- You can invoke the **Lx51** linker/locator with the **NOOVERLAY** option to disable data overlaying for the entire application.
- The **Lx51** linker/locator control **OVERLAY** (*sfname* ! *) disables data overlaying for the function specified by *sfname*.
- C code that is translated with the **Cx51** compiler directive **OPTIMIZE (1)** does not use the relocation type **OVERLAYABLE**. Therefore the local data segments of this code portions cannot be overlaid.

9

Pointer to a Function as Function Argument

In the following example `indirectfunc1` and `indirectfunc2` are indirectly called through a function pointer in `execute`. The value of the function pointer is passed in the function `main`. Since `main` contains the reference, the **Lx51** linker/locator *thinks* that `main` calls `indirectfunc1` and `indirectfunc2`. But this is incorrect, since the *real* function call is in the function `execute`.

Following is a program listing for this example.

```
:
:
bit indirectfunc1 (void) { /* indirect function 1 */
    unsigned char n1, n2;
    return (n1 < n2);
}

bit indirectfunc2 (void) { /* indirect function 2 */
    unsigned char a1, a2;
    return ((a1 - 0x41) < (a2 - 0x41));
}

void execute (bit (*fct) ()) { /* sort routine */
    unsigned char i;
    for (i = 0; i < 10; i++) {
        if (fct ()) i = 10;
    }
}

void main (void) {

    if (SWITCH) /* switch: defines function */
        execute (indirectfunc1);
    else
        execute (indirectfunc2);
}
:
:
```

The following listing file shows the overlay map for the program before making adjustments with the **OVERLAY** control.

```
OVERLAY MAP OF MODULE:  OVL1 (OVL1)
```

| SEGMENT +--> CALLING SEGMENT | BIT-GROUP | | DATA-GROUP | |
|---------------------------------|-----------|--------|------------|--------|
| | START | LENGTH | START | LENGTH |
| ?C_C51STARTUP | ----- | ----- | ----- | ----- |
| +--> ?PR?MAIN?OVL1 | | | | |
| ?PR?MAIN?OVL1 | ----- | ----- | ----- | ----- |
| +--> ?PR?INDIRECTFUNC1?OVL1 | | | | |
| +--> ?PR?EXECUTE?OVL1 | | | | |
| +--> ?PR?INDIRECTFUNC2?OVL1 | | | | |
| ?PR?INDIRECTFUNC1?OVL1 | ----- | ----- | 0008H | 0002H |
| ?PR?EXECUTE?OVL1 | ----- | ----- | 0008H | 0004H |
| ?PR?INDIRECTFUNC2?OVL1 | ----- | ----- | 0008H | 0002H |

The entry for `?PR?MAIN?OVL1` shows a call to `?PR?INDIRECTFUNC1?OVL1`, `?PR?EXECUTE?OVL1`, and `?PR?INDIRECTFUNC2?OVL1`. However, only the function `execute` is called from `main`. The other references are results from using the function pointer `fect`, which is passed to `execute`. The function call to `indirectfunc1` and `indirectfunc2` takes place in `execute`, not in `main` where the functions are referenced.

In this situation, the linker/locator cannot locate the actual function calls. Therefore, the **Lx51** linker/locator incorrectly overlays the local segments of the functions `execute`, `indirectfunc1`, and `indirectfunc2`. This might result in a data overwrites of the variables `i` and `fect`.

You can use the **OVERLAY** control to correct the function call tree as it seen by the linker. For this example, you must remove the references from `main` to `indirectfunc1` and `indirectfunc2`. Do this with `main ~ (indirectfunc1, indirectfunc2)`. Then, add the actual function call from `execute` to `indirectfunc1` and `indirectfunc2` with `executed ! (indirectfunc1, indirectfunc2)`. The following shows the complete linker invocation line for this example.

```
Lx51 OVL1.OBJ OVERLAY (main ~ (indirectfunc1, indirectfunc2),
                       execute ! (indirectfunc1, indirectfunc2))
```

With this **Lx51** invocation the overlay map shows the correct references.

```
OVERLAY MAP OF MODULE:  OVL1 (OVL1)
```

| SEGMENT | BIT-GROUP | | DATA-GROUP | |
|-----------------------------|-----------|--------|------------|--------|
| | START | LENGTH | START | LENGTH |
| +--> CALLING SEGMENT | | | | |
| ----- | | | | |
| ?C_C51STARTUP | ----- | ----- | ----- | ----- |
| +--> ?PR?MAIN?OVL1 | | | | |
| ?PR?MAIN?OVL1 | ----- | ----- | ----- | ----- |
| +--> ?PR?EXECUTE?OVL1 | | | | |
| ?PR?EXECUTE?OVL1 | ----- | ----- | 0008H | 0004H |
| +--> ?PR?INDIRECTFUNC1?OVL1 | | | | |
| +--> ?PR?INDIRECTFUNC2?OVL1 | | | | |
| ?PR?INDIRECTFUNC1?OVL1 | ----- | ----- | 000CH | 0002H |
| ?PR?INDIRECTFUNC2?OVL1 | ----- | ----- | 000CH | 0002H |

Pointer to a Function in Arrays or Tables

Another typical scenario is an array that contains a pointer to a function. This is typical for applications with function tables. In the following example, `func1` and `func2` are called indirectly by `main` but the entry points are stored as constant values in the table `funcstab`. This table is located in the segment `?CO?modulname`. Therefore, the `?CO?OVL2` segment contains references to `func1` and `func2`.

In reality, however, the calls are executed from the `main` function. But, the **Lx51** linker/locator assumes that `func1` and `func2` are recursive called, because in `func1` and `func2` constant strings are used. These constants strings are also stored in the segment `?CO?OVL2`. The result is that the **Lx51** linker/locator reports warnings which indicate recursive calls from the segment `?CO?OVL2` to `func1` and `func2`.

The following listing shows part of the OVL2 program.

```
.
.
.
void func1 (void) {
    unsigned char i;                                /* function 1 */

    for (i = 0; i < 10; i++) printf ("THIS IS FUNCTION1\n");
}

void func2 (void) {
    unsigned char i;                                /* function 2 */

    for (i = 0; i < 10; i++) printf ("THIS IS FUNCTION2\n");
}

code void (*functab []) () = {func1, func2};        /* function table */

void main (void) {
    (*functab [P1 & 0x01]) ();
}
.
.
.
```

The **Lx51** linker/locator generates typically warnings when you generate programs that contain a table with pointer to functions. Although the program can be executed correct in this example above, the references should be adjusted to the real calls. In the real application the functions **func1** and **func2** are called by the **main** function.

If you are using the **BL51** linker/locator in the default configuration you need to delete the references from the code segment that contains the tables with **?CO?OVL2 ~ (func1, func2)**. Then you need to add the calls from **main** to **func1** and **func2** with **main ! (func1, func2)**:

```
BL51 OVL2.OBJ OVERLAY (?CO?OVL2~(func1, func2), main!(func1, func2))
```

The **SPEEDOVL** control of **BL51** ignores all references from constant segments to program code. This is also the operation mode of **LX51** and **L251**. Therefore you need only to add the calls from **main** to **func1** and **func2** with **main ! (func1, func2)**:

```
BL51 OVL2.OBJ OVERLAY (main ! (func1, func2)) SPEEDOVL
```

The **LX51** and **L251** linker/locator always ignores the references from constant segments to program code and requires only to add the function calls:

```
LX51 OVL2.OBJ OVERLAY (main ! (func1, func2))
```

After this correction the memory usage of your application is typically more efficient and the overlay map shows a call tree that matches your application. Also the linker/locator does not generate any warning messages.

```
OVERLAY MAP OF MODULE:  OVL2 (OVL2)

SEGMENT                BIT-GROUP                DATA-GROUP
+--> CALLING SEGMENT   START  LENGTH           START  LENGTH
-----
?C_C51STARTUP          -----
+--> ?PR?MAIN?OVL2
?PR?MAIN?OVL2          -----
+--> ?PR?FUNC1?OVL2
+--> ?PR?FUNC2?OVL2
?PR?FUNC1?OVL2        -----                0008H  0001H
+--> ?PR?PRINTF?PRINTF
?PR?PRINTF?PRINTF     -----                0009H  0014H
+--> ?PR?PUTCHAR?PUTCHAR
?PR?FUNC2?OVL2        -----                0008H  0001H
+--> ?PR?PRINTF?PRINTF
```

Tips and Tricks for Program Locating

9

The **Lx51** linker/locator supports several techniques that are required in for special tasks, for example in-system Flash programming or systems that use a RAM section for constants. The following section provides examples that show the usage of the **Lx51** linker/locator in such situations.

Locate Segments with Wildcards

The **Lx51** linker/locator allows in the segment controls wildcards for specifying the segment name. For example you may use such segment name specifications to locate all segments within one module into one 2KB block. In this way you can use the **ACALL** and **AJMP** instructions for function calls within this module.

```
BL51 myfile.obj CODE (?PR?*?myfile (0x1000))  
LX51 myfile.obj SEGMENTS (?PR?*?myfile (C:0x1000))
```

9

Special ROM Handling (LX51 & L251 only)

The LX51 and L251 linker/locator provide the memory class SROM that is used to handle segments or memory classes that are to be stored in ROM, but copied for execution into RAM areas. This is useful for:

- In-system Flash programming when the Flash ROM contains also the flash programming code. With standard Flash devices it is impossible to fetch program code from the while other parts of the device are erased or programmed. The *Keil Application Note 139: “In-system Flash Programming with 8051 and 251”* that is available on www.keil.com or the Keil development tools CD-ROM contains a program example.
- For using the C251 **TINY** or **XTINY** memory model it is required to provide a NCONST memory class in the lowest 64KB memory region. However, if only RAM is mapped into this memory region, you can specify a different storage address for the NCONST memory class and copy the content at the program start into RAM. This allows you to use the efficient **TINY** or **XTINY** memory model while the system hardware just provides RAM in the lowest 64KB memory segment. Refer to “Use RAM for the 251 Memory Class NCONST” on page 292 for a program example.

Refer to **Lx51** linker/locator controls “SEGMENTS” on page 346 and “CLASSES” on page 336 for syntax on defining segments and memory classes that have a different storage and execution address.

Segment and Class Information (LX51 & L251 only)

The Lx51 linker/locater creates special symbols that can be used to obtain address and length information for segments or classes used in an application. The information is passed via external variable declarations. The Lx51 linker/locater uses symbols with the notation *segmentname_p_* or *_classname_p_*. Question mark (?) characters in the segment name generated by the Cx51 compiler are replaced with underscore (_) characters. The postfix *_p_* specifies the information that should be obtained and is explained in the following table:

| Postfix | Description |
|------------|---|
| <u>_l_</u> | is the length in bytes of the segment or memory class. For a memory class this number includes also any gaps that are required to allocate all segments that belong to this memory class. |
| <u>_s_</u> | is the start address of the segment or memory class. For a memory class this number refers to the first segment that belongs to this memory class. |
| <u>_e_</u> | is the end address of the segment or memory class. For a memory class this number refers to the last segment that belongs to this memory class. |
| <u>_t_</u> | is the target or execution address of the segment or memory class. For a memory class this number refers to the first segment that belongs to this memory class. This information is only available for segments or memory classes which have assigned a different storage and execution address. |

Examples:

If `?PR?FUNC1` is the segment name:

| | |
|---------------------------------|--|
| <code><u>_PR_FUNC1_L</u></code> | is the length in bytes of the segment <code>?PR?FUNC1</code> . |
| <code><u>_PR_FUNC1_S</u></code> | is the start address of the segment <code>?PR?FUNC1</code> . |
| <code><u>_PR_FUNC1_E</u></code> | is the end address of the segment <code>?PR?FUNC1</code> . |
| <code><u>_PR_FUNC1_T</u></code> | is the target or execution address of the segment <code>?PR?FUNC1</code> . |

If `NCONST` is the memory class name:

| | |
|-------------------------------|--|
| <code><u>_NCONST_L</u></code> | is the length in bytes of the memory class <code>NCONST</code> . |
| <code><u>_NCONST_S</u></code> | is the start address of the memory class <code>NCONST</code> . |
| <code><u>_NCONST_E</u></code> | is the end address of the memory class <code>NCONST</code> . |
| <code><u>_NCONST_T</u></code> | is the target or execution address of the memory class <code>NCONST</code> . |

You may access this information in **Cx51** applications as shown in the following program example:

```
extern char _PR_FUNC1_L_;

unsigned int get_length (void) {
    return ((unsigned int) &_PR_FUNC1_L_); // length of segment ?PR?FUNC1
}
```

The file **SROM.H** contains macro definitions for accessing segment and class information. Refer to the *Keil Application Note 139: "In-system Flash Programming with 8051 and 251"* for more information.

Use RAM for the 251 Memory Class NCONST

The C251 compiler memory model **TINY** or **XTINY** requires a **NCONST** memory class in the lowest 64KB memory region. If your hardware provides only RAM in this memory area, you may use the **SROM** memory class to store the constants somewhere in the 16MB memory space and you may copy the content of the **NCONST** memory class into a RAM in the lowest 64KB memory. This is shown in the following program example. Refer to the "CLASSES" control on page 336 for more information.

```
#include <string.h>

extern char huge _NCONST_S_;
extern char huge _NCONST_T_;
extern char near _NCONST_L_;

const char text [] = "This text is accessed in the NCONST memory class";

void main (void) {
    fmemcpy (&_NCONST_T_, &_NCONST_S_, (unsigned int)&_NCONST_L_);
    :
}
```

The C251 compiler and L251 linker/locator is invoke as follows:

```
C251 SAMPLE.C XTINY DEBUG
L251 SAMPLE.C CLASSES (NCONST (0x2000-0x4000) []), SROM (0xFE0000-0xFEFFFF)
```

Bank Switching

9

The **Lx51** linker/locator manages and allows you to locate program code in up to 32 code banks and one common code area. The common code area is always available for all the code banks. The common code area and other aspects of the code banking are described below.

Common Code Area

The common code area can be accessed by all banks. This area usually includes routines and constant data that must always be accessible; for example, interrupt and reset vectors, interrupt routines, string constants, bank switching routines, etc. The following code sections must always be located in the common area:

- **Reset and Interrupt Vectors:** reset and interrupt jump entries must remain in the common area, since the code bank selected by the **x51** program is not known at the time of the CPU reset or interrupt. The **Lx51** linker/locator, therefore, locates absolute code segments in the common area in each case.
- **Code Constants:** constant values (strings, tables, etc.) which are defined in the code area must be stored in the common area unless you guarantee that the code bank containing the constant data is selected at the time they are accessed by program code. You can relocate these segments in code banks by means of control statements.
- **Interrupt Functions:** generated using the **Cx51** compiler must always be located in the common area. However, interrupt functions can call functions in other code banks. The **Lx51** linker/locator produces a warning when an attempt is made to locate a **Cx51** interrupt function in a code bank.
- **Bank Switch Code:** is required for switching the code banks as well as the associated jump table are located in the common area since these program sections are required by all banks. By default, the **Lx51** linker/locator automatically locates these segments in the common area. Do not attempt to locate these program sections into bank areas.
- **Library Functions:** intrinsic run-time library functions used by the **Cx51** compiler or the PL/M-51 compiler must be located in the common area. It is possible that the bank switch code will use registers that are used to transfer values to such library functions. Therefore, the **Lx51** linker/locator always locates program sections of the runtime library in the common area. Do not locate these program sections in other bank areas.

It is difficult to estimate the size of the common area. The size will always depend on the particular software application and hardware constraints. If the ROM area that is dedicated as common area is not large enough to contain the entire common code, the **Lx51** linker/locator will duplicate the remaining part of the common code area into each code bank. This is also the case, if your hardware does not provide a common code area section in the ROM space.

Code Bank Areas

The classic 8051 only provides 16 address lines for accessing code memory. With 16 address lines, only 64 KBytes of code space can be accessed. Code banks are addressed using up to five additional address lines that must originate from 8051 I/O ports or from external hardware devices (latch or port I/O device) that are mapped into the XDATA space. A particular code bank is selected by controlling the state of the additional address lines. Up to 32 banks can be used.

Code banking applications must include the assembly file **L51_BANK.A51** that is located in the folder **LIB**. This source module contains the code that is invoked to switch code banks. You must configure this source file to match the bank switching technique used by your target hardware. Refer to “Bank Switching Configuration” on page 297 for a description of this source file.

Optimum Program Structure with Bank Switching

The **Lx51** linker/locator automatically generates a jump table for all functions, which are stored in the bank area and are called from the common area or from other banks. The **Lx51** linker/locator only uses bank switching when the program section called actually lies in another memory bank or when it can be called from the common area. This improves performance and prevents bank switching from significantly impacting the performance of your application program. Additionally, the memory and stack requirements for this bank switching technique are considerably smaller than other alternative solutions.

Each bank switch takes on a classic 8051 approximately 50 CPU cycles and requires two additional bytes in the stack area. Bank switches are relatively fast, however, programs should be structured so that bank switches are seldom required to achieve maximum performance. This means that functions that are frequently invoked and functions that are called from multiple code banks should be located in the common code area.

Program Code in Bank and Common Areas

The **Lx51** linker/locator provides the **BANKAREA**, **BANKx**, and **COMMON** controls to specify the location and size of the bank switching area and to locate segments in code banks or the common area.

When you generate a code banking application, you must specify the modules you want located in a code bank or common area. This is accomplished using **BANKx** or **COMMON** in the *inputlist* portion of the **Lx51** linker/locator command line.

BANKx in the *inputlist* specifies the code bank for object and library files. The *x* in the **BANKx** keyword specifies a bank number from 0 to 31. For example, **BANK0** for code bank number 0, **BANK1** for code bank number 1, and so on. All program code segments contained in these modules will be located in the specified code bank. A program code segment is determined by its prefix or postfix **?PR?**.

COMMON locates program code into the common area. This is also the default for modules that are not explicitly located with **BANKx**.

The general format for **BANKx** and **COMMON** in the *inputlist* are:

```
BANKx { filename [(modulename)] [, filename ...] } [, ...]
COMMON { filename [(modulename)] [, filename ...] } [, ...]
```

where

x is the bank number to use and can be a number from 0 to 15.
 { and } are used to enclose object files or library files.
filename is the name of an object file or library file.
modulename is the name of an object module in a library file.

The start and end address of the area where the code banks are located is specified with the **BANKAREA** control. These address range should reflect the space where the code bank ROMs are physically mapped. All program code segments that are assigned to a bank will with the **BANKx** keyword in the *inputlist* will be located within this address range. Refer to “**BANKAREA**” on page 332 for more information.

Command-Line Example:

A typical **Lx51** linker/locator command line appears as follows. More “**Error! Reference source not found.**” can be found on page **Error! Bookmark not defined.**

```
LX51 COMMON{C_ROOT.OBJ},
      BANK0{C_BANK0.OBJ, MODUL1.OBJ},
      BANK1{C_BANK1.OBJ},
      BANK2{C_BANK2.OBJ}
      TO MYPROG.ABS &
      BANKAREA(8000H,0FFFFH)
```

Segments in Bank Areas

In the *controls* portion of the **BL51** linker/locator command line you can use the **BANKx** control to locate or order segments within a code bank. Refer to “**BANKx**” on page 333 for more information.

For the **LX51** linker/locator the **SEGMENTS** control allows you also to locate or order segments within a code banks. Refer to “**SEGMENTS**” on page 346 for more information.

With these controls you may place constants in code banks. You can use this technique to locate arrays or large tables in code banks other than the one in which your program resides. However, in your **Cx51** programs, you must manually ensure that the proper code bank is used when accessing that constant data. You can do this with the **switchbank** function which is defined in the **L51_BANK.A51** module. “**BANK_EX2 – Banking with Constants**” on page 407 shows a complete example program.

Bank Switching Configuration

When you create a code banking application, you must specify the number of code banks your hardware provides as well as how the code banks are switched. This is done with definitions in an assembler source file. For the classic 8051 devices the bank switch configuration is defined in the file **L51_BANK.A51** found in the `\C51\LIB\` subdirectory. For the Philips 80C51MX the file **MX51BANK.A51** is used.

NOTE

For extended 8051 devices there are several **Keil Application Notes** available on www.keil.com or the Keil development tools CD-ROM that explain the banking and memory configuration for these devices.

The following table explains the definitions in the Bank Configuration File:

| Name | Description |
|---|---|
| ?B_NBANKS | number of banks to be supported. The following values are allowed: 2, 4, 8, 16, and 32. Two banks require one additional address (or I/O Port) line; four banks require two lines; eight banks require three lines; sixteen banks require four lines, and thirty-two banks require five address lines. |
| ?B_MODE | indicates the way how the address extension is done. 0 for using an standard 8051 I/O Port, 1 for using an XDATA port; 2 for using 80C51MX address line; and 4 for user provide bank switch code. |
| ?B_RTX | specifies if the application uses RTX-51 Full. Only ?B_MODE 0 and 1 are supported by RTX51 Full. |
| ?B_VARBANKING | Enables variable banking in XDATA and CODE memory. Variable banking requires the LX51 linker/locater. It is not supported by BL51 . Refer to "Banking With Common Area" on page 303 for an example on how to setup the LX51 linker/locater. |
| ?B_RST_BANK | Specifies the default bank that is selected after CPU reset. This setting is used by the LX51 linker/locater to reduce the entries in the INTERBANK CALL TABLE. The value 0xFF disables this optimization. This value is not used by BL51 . |
| For ?B_MODE = 0 (bank switching via 8051 I/O Port) define the following: | |
| ?B_PORT | used to specify the address of the internal data port. The SFR address of an internal data port must be specified. (For example: P1 as for port 1). |
| ?B_FIRSTBIT | indicates which bit of the 8051 I/O port is to be assigned first. The value 3 indicates that port bit 3 is used as first port line for the address extension. If, for example, two address lines are used, P1.3 and P1.4 are allocated in this case. The remaining lines of the 8051 I/O port can be used for other purposes. |

9

| Name | Description |
|--|---|
| For ?B_MODE = 1 (bank switching via xdata mapped port) define the following: | |
| ?B_XDATAPORT | specifies the XDATA memory address used to select the bank address and defines the address of an external data port. Any XDATA address can be specified (address range 0H to 0FFFFH) under which a port can be addressed in the XDATA area. 0FFFFH is defined as the default value. In this mode ?B_CURRENTBANK and ?B_XDATAPORT are initialized with the value 0 at the start of the program by the C51 startup code. |
| ?B_FIRSTBIT | indicates which bit of the defined port is to be assigned first. Other than with ?B_MODE=0 the remaining bits of the XDATA port cannot be used for other purposes. |
| For ?B_MODE = 4 (bank switching via user provided code) define the following: | |
| SWITCHx | For each memory bank a own macro defines the bank switch code. The number of macros must conform with the ?B_NBANKS definition. For example 4 banks require a SWITCH0 , SWITCH1 , SWITCH2 and SWITCH3 macro. Each macro must generate exactly the same number of code bytes. If the size is different you use should NOP instructions to make it identical. You must also ensure that the CPU has selected a defined state at startup. The RTX51 real-time operating system does not support this banking mode. |

The **Ax51** assembler is required to assemble **L51_BANK.A51** or **MX51BANK.A51**. The source file should be copied as part of your project file. Public Symbols in **L51_BANK.A51**

Additional **PUBLIC** Symbols are provided in **L51_BANK.A51** for your convenience. They are described below.

| Name | Description |
|-----------------------|---|
| ?B_CURRENTBANK | is a memory location in the DATA or SFR memory, which contains the currently selected memory bank. This memory location can be read for debugging. A modification of the memory location, however, does not cause a bank switching in most cases. Only required bits based on setting of ?B_NBANKS and ?B_FIRSTBIT are valid in this memory location. The bits, which are not required, must be masked out with a corresponding mask. |
| _SWITCHBANK | is a Cx51 compatible function, which allows the bank address to be selected by the user program. This function can be used for bank switching if the constant memory is too small. Note that this C function can be called only from code in the common area. The function is accessed as follows: <pre>extern void switchbank (unsigned char bank_number); : : switchbank (0);</pre> |

Configuration Examples

The following examples demonstrate how to configure code banking.

Banking With Four 64 KByte Banks

This example demonstrates the configuration required to bank switch using one 256KB EPROM. The following figure illustrates the hardware schematic.

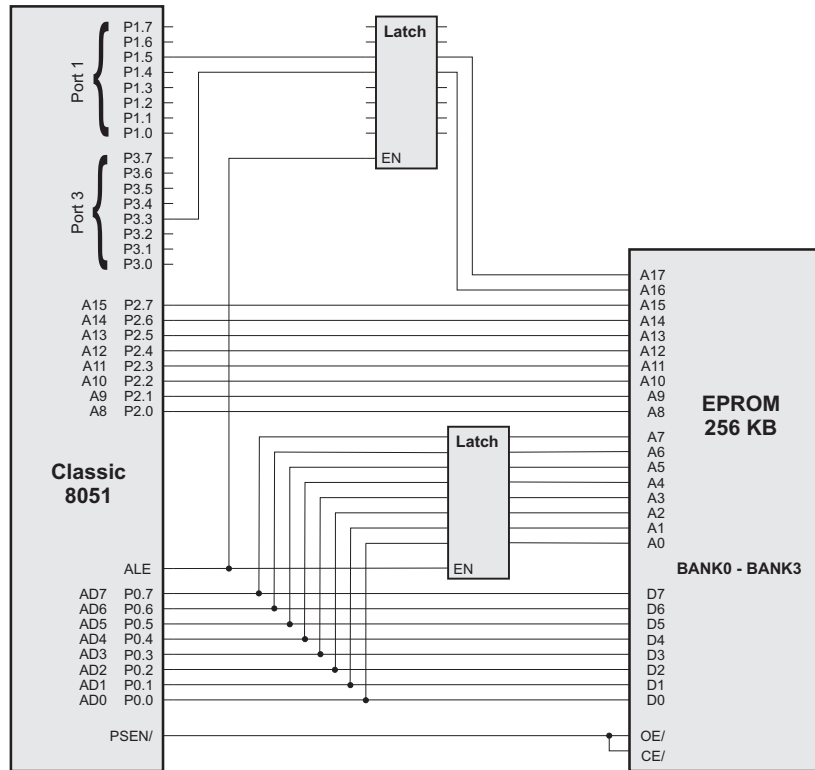

The following figure illustrates the memory map for this example.

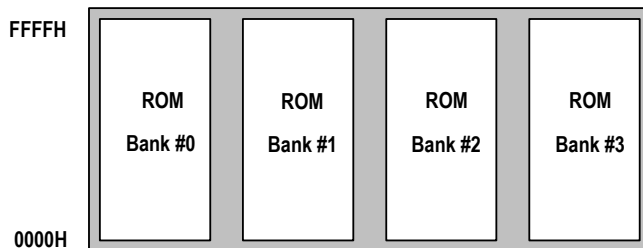

One 256KB EPROM is used in this hardware configuration. The bank switching can be implemented by using two bank select address lines (in this example Port 1.5 and Port 3.3). `L51_BANK.A51` can be configured as follows for this hardware configuration.

```
?N_BANKS EQU 4 ; Four banks are required.
?B_MODE EQU 4 ; user-provided bank switch code is used.
```

The section that starts with `IF ?B_MODE = 4` defines the code that switches between the code banks. This section needs to be configured as follows:

```
P1 DATA 90H ; I/O Port Addresses *
P3 DATA 0B0H ; *
; *
SWITCH0 MACRO ; Switch to Memory Bank #0 *
CLR P3.3 ; Clear Port 3 Bit 3 *
CLR P1.5 ; Clear Port 1 Bit 5 *
ENDM *
; *
SWITCH1 MACRO ; Switch to Memory Bank #1 *
SETB P3.3 ; Set Port 3 Bit 3 *
CLR P1.5 ; Clear Port 1 Bit 5 *
ENDM *
; *
SWITCH2 MACRO ; Switch to Memory Bank #2 *
CLR P3.3 ; Clear Port 3 Bit 3 *
SETB P1.5 ; Set Port 1 Bit 5 *
ENDM *
; *
SWITCH3 MACRO ; Switch to Memory Bank #3 *
SETB P3.3 ; Set Port 3 Bit 3 *
SETB P1.5 ; Set Port 1 Bit 5 *
ENDM *
```

You need to ensure that the CPU starts in a defined state at reset. Therefore the following code needs to be added to the `STARTUP.A51` file of your application:

```
MOV SP,#?STACK-1
; added for bank switching
P1 DATA 90H ; I/O Port Addresses
P3 DATA 0B0H

EXTRN DATA (?B_CURRENTBANK)
MOV ?B_CURRENTBANK,#0 ; select code bank 0
CLR P3.3 ; Clear Port 3 Bit 3
CLR P1.5 ; Clear Port 1 Bit 5
; end
JMP ?C_START
```

The **Lx51** linker/locator automatically places copies of the code and data in the common area into each bank so that the contents of all EPROM banks are identical in the address range of the common area. The **BANKAREA** control is not required since the default setting already defines address range 0 to 0xFFFF as banked area.

Banking With On-Chip Code ROM

Several device variants offer SFR registers that configure the on-chip code ROM space. You may use this feature for existing hardware designs to introduce code banking. For example, if your hardware uses currently a Dallas 80C320 (ROM-less device) and an external 64KB ROM, you may increase the code space of this existing hardware design with Dallas 80C520 design that offers 16KB on-chip ROM. You may use the **ROMSIZE** SFR register for code bank switching of the 16KB on-chip and off-chip ROM block.

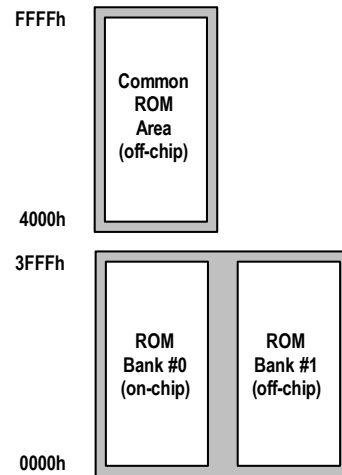

The figure on the right shows this memory layout. For this configuration the following settings in **L51_BANK.A51** are required.

```
?N_BANKS EQU 2 ; Two banks are required.
?B_MODE EQU 4 ; user-provided bank switch code is used.
```

The macros need to be configured as follows:

```
ROMSIZE DATA 0C2H ; SFR Address *
; *
SWITCH0 MACRO ; Switch to Memory Bank #0 *
MOV ROMSIZE,#05H ; Enable on-chip 16KB ROM *
ENDM *
; *
SWITCH1 MACRO ; Switch to Memory Bank #1 *
MOV ROMSIZE,#00H ; Disable on-chip 16KB ROM *
ENDM *
```

You need to ensure that the CPU starts in a defined state at reset. Therefore the following code needs to be added to the **STARTUP.A51** file of your application:

```
MOV SP,#?STACK-1
; added for bank switching
ROMSIZE DATA 0C2H ; SFR Address
EXTRN DATA (?B_CURRENTBANK)
MOV ?B_CURRENTBANK,#0 ; select code bank 0
MOV ROMSIZE,#05H ; start with on-chip ROM enabled
; end
JMP ?C_START
```

The **Lx51** linker/locator **BANKAREA** control should be set as follows:

```
BL51 ... BANKAREA (0,0x3FFF)
```

9

Banking With XDATA Port

You may also use a latch or I/O device that is mapped into the XDATA space to extend the address lines of the 8051 device. The following application illustrates a hardware that uses a latch mapped into the XDATA space to address a 512KB EPROM.

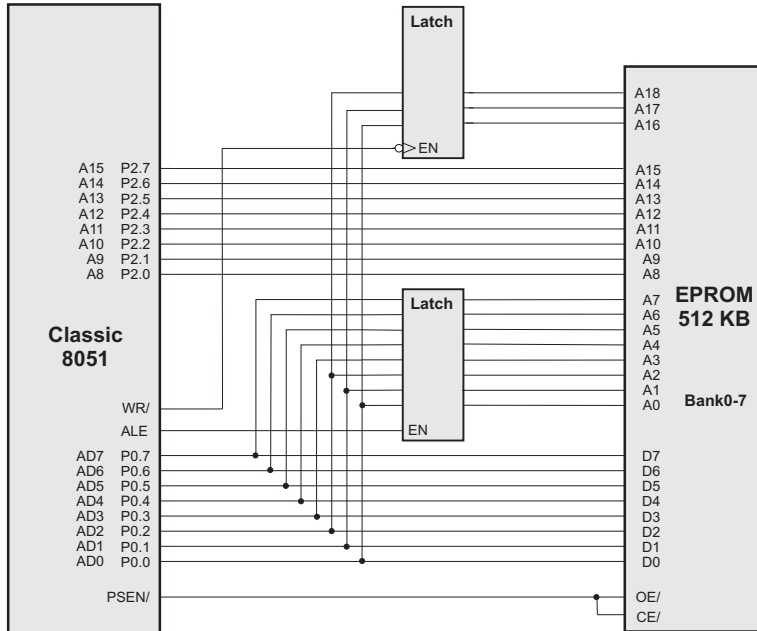

The following figure illustrates the memory map for this example.

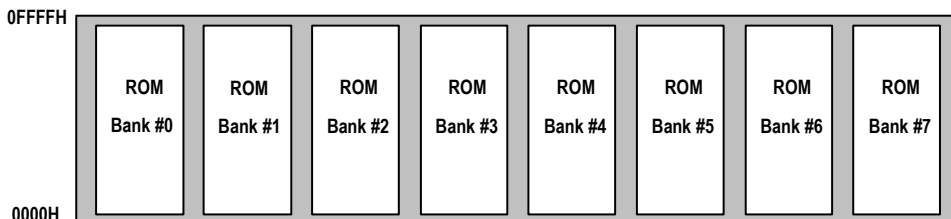

For this hardware the `L51_BANK.A51` file can be configured as follows:

```
?N_BANKS      EQU 8      ; Eight banks are required.
?B_MODE       EQU 1      ; bank switch via xdata port.
?B_XDATAPORT  EQU 0      ; any I/O address can be given for the example.
?B?FIRSTBIT   EQU 0      ; bit 0 is used as first address line.
```

You need no additional configuration in the `STARTUP.A51` file. The `Lx51` linker/locator automatically places copies of the code and data in the common

area into each bank so that the contents of all EPROM banks are identical in the address range of the common area. The **BANKAREA** control is not required since the default setting already defines address range 0 to 0xFFFF as banked area.

Banking With Common Area

The following schematic shows a hardware that offers a 32KB common area and seven 32KB code banks. A single EPROM is used to map the complete memory. Due to the address decoding logic, the code bank 0 is identical with the common area and should be therefore not used by your application. The design also provides 256KB xdata memory that is mapped the same way as the code memory. The xdata space might be used for variable banking.

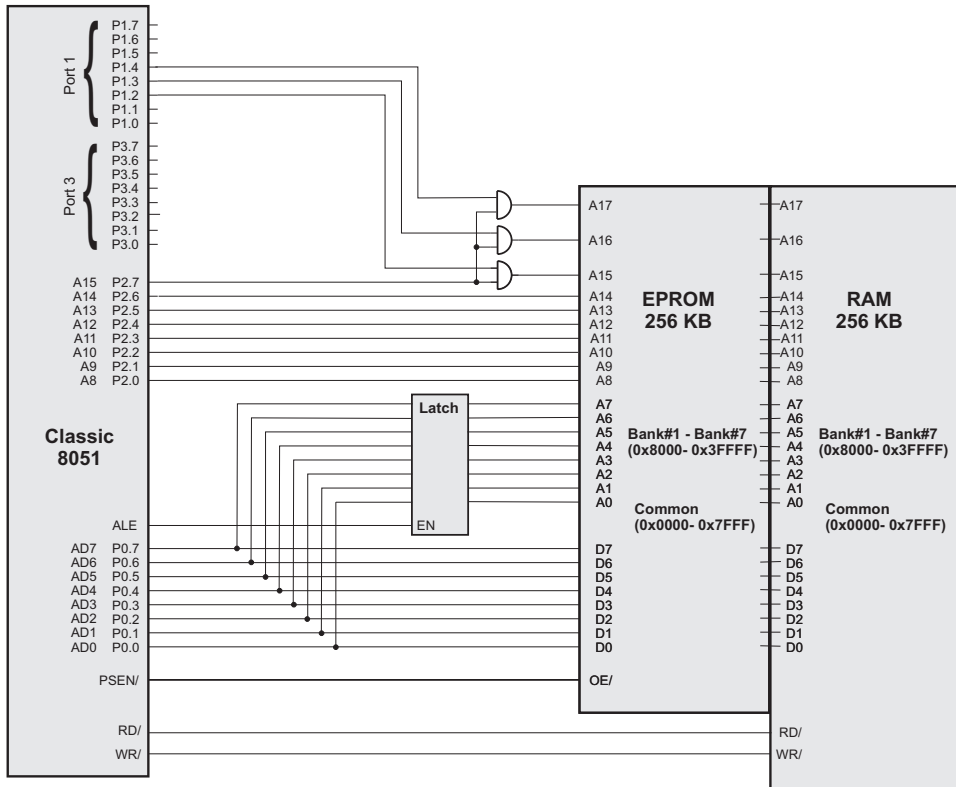

The following figure illustrates the memory map for this example.

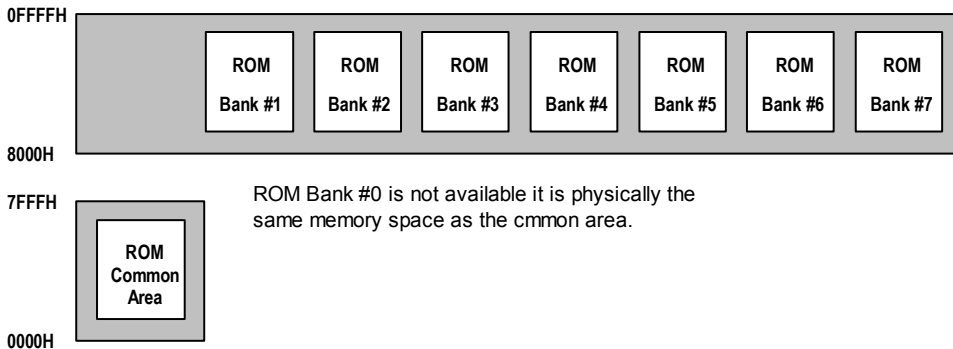

For this hardware the `L51_BANK.A51` file can be configured as follows:

```
?N_BANKS      EQU    8          ; Eight banks are required.
?B_MODE       EQU    0          ; banking via on-chip I/O Port.
?B_VAR_BANKING EQU    1          ; you may use also variable banking.
?B_PORT       EQU    090H       ; Port address of P1.
?B_FIRSTBIT   EQU    2          ; Bit 2 is used as the first address line.
```

You should not use the code bank 0 in your application, since this memory is effectively identical with the common area. Therefore no module of your application should be assigned to code bank 0. The **Lx51** linker/locator **BANKAREA** control should be set as follows:

```
BL51 BANK1 {A.OBJ}, ..., BANK7{G.OBJ} ... BANKAREA (0x8000,0xFFFF)
```

If you are using variable banking, you need to use **LX51** linker/locator. To define the additional memory the **HDATA** and **HCONST** memory classes are used. In this case the memory classes need to be set as follows:

```
LX51 BANK1 {A.OBJ}, ..., BANK7{G.OBJ} ... BANKAREA (0x8000,0xFFFF)
  CLASSES (XDATA (X:0-X:0x7FFF),
           HDATA  (X:0x18000-X:0x1FFFF,X:0x28000-X:0x2FFFF,
                  X:0x38000-X:0x3FFFF,X:0x48000-X:0x4FFFF,
                  X:0x58000-X:0x5FFFF,X:0x68000-X:0x6FFFF,
                  X:0x78000-X:0x7FFFF),
           HCONST (C:0x18000-C:0x1FFFF,C:0x28000-C:0x2FFFF,
                  C:0x38000-C:0x3FFFF,C:0x48000-C:0x4FFFF,
                  C:0x58000-C:0x5FFFF,C:0x68000-C:0x6FFFF,
                  C:0x78000-C:0x7FFFF))
```

Control Summary

9

This section describes all **Lx51** linker/locator command-line controls. The controls are grouped into the following categories:

- Listing File Controls
- Output File Controls
- Segment and Location Controls
- High-Level Language Controls

Many of the **Lx51** linker/locator controls allow you to specify optional arguments and parameters in parentheses immediately following the control. The following table lists the types of arguments that are allowed with certain controls.

| Argument | Description |
|------------------|---|
| address | A value representing a memory location. For BL51, L251 and LX51 in Philips 80C51MX mode plain numbers are used to represent an address. LX51 uses for classic 8051 devices a memory prefix in the address specification. For example: D:0x55 refers to DATA memory address 0x55 C:0x8000 refers to CODE memory address 0x8000 B4:0x4000 refers to CODE memory address 0x4000 in code bank 4. |
| classname | A name of a memory class. The x51 tools allows basic classes and user defined classes. Refer to “Memory Classes and Memory Layout” the page 27 for more information about memory classes. |
| filename | A file name that corresponds to the Windows file name conventions. |
| modname | A module name. Can be up to 40 characters long and must start with: A – Z, ?, _ , or @ ; following characters can be: 0 – 9, A – Z, ?, _ , or @ . |
| range | An address range in the format: <div style="text-align: center;">startaddress [– endaddress]</div> The startaddress is the first address specified by the range. The endaddress is optional and specifies the last address which is included in the address range. |
| segname | A segment name. Can be up to 40 characters long and must start with: A – Z, ?, _ , or @ ; following characters can be: 0 – 9, A – Z, ?, _ , or @ . |
| sfname | A segment or function name. |
| value | A number, for example, 1011B, 2048D, 0x1000, or 0D5FFh. |

9

Listing File Controls

The **Lx51** linker/locator generates a listing file that contains information about the link/locate process. This file is sometimes referred to as a map file. The following controls specify the filename, format, and information that is included in the listing file. For a detailed description of each control refer to the page listed in the table.

| BL51 | LX51, L251 | Page | Description |
|------------------------------|-------------------------------|-------------|--|
| <u>DISABLEWARNING</u> | <u>DISABLEWARNING</u> | 307 | Disables specified warning messages. |
| <u>IXREF</u> | <u>IXREF</u> | 308 | Includes a cross reference report. |
| - | <u>NOCOMMENTS</u> | 309 | Excludes comment information. |
| <u>NOLINES</u> | <u>NOLINES</u> | 310 | Excludes line number information. |
| <u>NOMAP</u> | <u>NOMAP</u> | 311 | Excludes memory map information. |
| <u>NOPRINT</u> | <u>NOPRINT</u> | 315 | Disables generation of a listing file. |
| <u>NOPUBLICS</u> | <u>NOPUBLICS</u> | 312 | Excludes public symbol information. |
| <u>NOSYMBOLS</u> | <u>NOSYMBOLS</u> | 313 | Excludes local symbol information. |
| <u>PAGELLENGTH(n)</u> | <u>PAGELLENGTH(n)</u> | 314 | Sets number of lines in each page. |
| <u>PAGEWIDTH(n)</u> | <u>PAGEWIDTH(n)</u> | 314 | Sets number of characters in each line. |
| <u>PRINT</u> | <u>PRINT</u> | 315 | Specifies the name of the listing file. |
| - | <u>PRINTCONTROLS</u> | 316 | Excludes specific debugging information. |
| - | <u>PURGE</u> | 317 | Excludes all debugging information. |
| - | <u>WARNINGLEVEL(n)</u> | 318 | Controls the types and severity of warnings generated. |

DISABLEWARNING

Abbreviation: DW

Arguments: `DISABLEWARNING (number, [...])`

Default: All warning messages are displayed.

µVision2 Control: Options – Lx51 Misc – Warnings – Disable Warning Numbers.

Description: The **DISABLEWARNING** control lets you to selectively disable Linker warnings. The warning numbers that should be suppressed are specified in parenthesis.

The following examples disables the report of Warning Number 1 and 5.

Example: `LX51 myfile.obj DISABLEWARNING (1, 5)`

IXREF

Abbreviation: IX

Arguments: IXREF [(NOGENERATED, NOLIBRARIES)]

Default: No cross reference is generated in the listing file.

µVision2 Control: Options – Listing – Linker Listing – Cross Reference

Description: The **IXREF** control instructs the **Lx51** linker/locator to include a cross reference report in the listing file. The cross reference is an alphabetically sorted list of all **PUBLIC** and **EXTERN** symbols in your program along with memory type and module names. The first module name is the module in which the **PUBLIC** symbol is defined. Further module names show the modules in which the **EXTERN** symbol is defined. If no **PUBLIC** symbol is present, **** UNRESOLVED **** is shown as first module name.

The option **NOGENERATED** suppresses symbols starting with '?'. These question mark symbols are normally produced by the compiler for calling specific C functions or passing parameters.

The option **NOLIBRARIES** suppresses those symbols, which are defined in a library file.

Example:

```
BL51 myfile.obj IXREF
LX51 myfile.obj IXREF (NOGENERATED)
L251 myfile.obj IXREF(NOLIBRARIES, NOGENERATED)
```

NOCOMMENTS

9

- Restriction:** This control is available in **LX51** and **L251** only.
- Abbreviation:** **NOCO**
- Arguments:** None
- Default:** include comment information.
- Description:** The **NOCOMMENTS** control removes the comment records contained in the input files from the listing file **and** the object output file. Comment records are added to the object module to identify the compiler or assembler that produced the object file. If you want to exclude comment information just from the listing file you have to use the **PRINTCONTROL** control.
- See Also:** **OBJECTCONTROLS, PRINTCONTROLS**
- Example:** `L251 MYPROG.OBJ NOCOMMENTS`

NOLINES

Abbreviation: NOLI

Arguments: None

Default: Include line number information

µVision2 Control: Options – Listing – Linker Listing – Line Numbers

Description: For the **BL51** linker/locator, the **NOLINES** control excludes line number information in the listing file.

For the **LX51** linker/locator and the **L251** linker/locator, the **NOLINES** control excludes line number information in the listing file **and** object output file. If you want to exclude line number information just from the listing file you have to use the **PRINTCONTROL** control.

NOTE

*Line numbers are address information about the source code lines and are used for debugging purposes. The **Lx51** linker/locator generates line numbers for source modules in your program only, if the **Ax51** assembler and **Cx51** compiler include that information in the input object files. Refer to the assembler control **NOLINES** on page 215 and to the *Cx51 User's Guide* for information on including line number information in the object files.*

See Also: **NODEBUGLINES, PRINTCONTROLS, OBJECTCONTROLS**

Example: `BL51 MYPROG.OBJ NOLINES`

NOMAP

Abbreviation: NOMA

Arguments: None

Default: Include a memory map in the listing file.

µVision2 Control: Options – Listing – Linker Listing – Memory Map

Description: The **NOMAP** control prevents the **Lx51** linker/locator from including the memory map in the listing file.

Example: `BL51 MYPROG.OBJ NOMAP`

9

NOPUBLICS

Abbreviation: NOPU

Arguments: None

Default: Include information about public symbols

µVision2 Control: Options – Listing – Linker Listing – Public Symbols

Description: For the **BL51** linker/locator, the **NOPUBLICS** control excludes public symbols from the listing file.

For the **LX51** linker/locator and the **L251** linker/locator, the **NOLINES** control excludes public symbols from the listing file **and** object output file. If you want to exclude public symbols just from the listing file you have to use the **PRINTCONTROLS** control.

See Also: **NODEBUGPUBLICS, PRINTCONTROLS, OBJECTCONTROLS**

Example: `BL51 MYPROG.OBJ NOPUBLICS`

NOSYMBOLS

Abbreviation: NOSY

Arguments: None

Default: Include information about local program symbols

µVision2 Control: Options – Listing – Linker Listing – Local Symbols

Description: For the **BL51** linker/locator, the **NOSYMBOLS** control excludes local symbols from the listing file.

For the **LX51** linker/locator and the **L251** linker/locator, the **NOSYMBOLS** control excludes local symbols from the listing file **and** object output file. If you want to exclude local symbols just from the listing file you have to use the **PRINTCONTROLS** control.

NOTE

*Symbols information is typically used for debugging purposes. The **Lx51** linker/locator generates symbol information for source modules in your program only, if the **Ax51** assembler and **Cx51** compiler include that information in the input object files. Refer to the assembler control **DEBUG** on page 203 and to the *Cx51 User's Guide* for information on including symbol information in the object files.*

See Also: **NODEBUGSYMBOLS, PRINTCONTROLS, OBJECTCONTROLS**

Example: `BL51 MYPROG.OBJ NOSYMBOLS`

9

PAGELENGTH / PAGEWIDTH

Abbreviation: PL

Arguments: PAGELENGTH (*value*)
PAGEWIDTH (*value*)

Default: PAGELENGTH (60)
PAGEWIDTH (132)

µVision2 Control: Options – Listing – Page Width, Page Length

Description: The **PAGELENGTH** control sets the maximum number of lines per page for the listing file.

The **PAGEWIDTH** control defines the maximum width of lines in the listing file. The page width may be set to a number in the 72 to 132 range.

Examples:

```
BL51 PROG.OBJ TO PROG.ABS PAGELENGTH(50) PAGEWIDTH(100)
```

```
L251 MYPROG.OBJ PAGELENGTH(30000) PAGEWIDTH(120)
```

PRINT / NOPRINT

Abbreviation: PR / NOPR

Arguments: PRINT (*filename*)

Default: The listing file is generated using the basename of the output file. BL51 use the extension **.M51**; LX51 and L251 use the extension **.MAP** as default for the listing file.

µVision2 Control: Options – Listing – Select Folder for Listing Files

Description: The **PRINT** control allows you to specify the name of the listing file that is generated by the **Lx51** linker/locator. The name must be enclosed in parentheses immediately following the **PRINT** control on the command line.

The **NOPRINT** control prevents the linker/locator from generating a listing file.

Example:

```
LX51 MYPROG.OBJ TO MYPROG.ABS PRINT (OUTPUT.MAP)
```

9

PRINTCONTROLS

Restriction: This control is available in **LX51** and **L251** only.

Abbreviation: **PC**

Arguments: **PRINTCONTROLS** (*subcontrol*[, ...])

Default: all debug information is printed in the listing file.

µVision2 Control: Options – Listing – Linker Listing

Description: The **PRINTCONTROLS** control allows you to remove specific debug information from the listing file. The *subcontrol* option can be one or more of the following parameters:

| <i>subcontrol</i> | Removes from the listing file ... |
|--------------------------|-----------------------------------|
| <u>N</u>OCOMMENTS | ... comment records. |
| <u>N</u>OLINES | ... line number information. |
| <u>N</u>OPUBLICS | ... public symbol information. |
| <u>N</u>OSYMBOLS | ... local symbol information. |
| <u>P</u>URGE | ... complete debug information. |

See Also: **NOCOMMENTS, NOLINES, NOPUBLICS, NOSYMBOLS, OBJECTCONTROLS, PURGE**

Example: `LX51 MYPROG.OBJ PRINTCONTROLS (NOLINES, NOSYMBOLS)`

PURGE

Restriction: This control is available in **LX51** and **L251** only.

Abbreviation: **PU**

Default: all debug information is processed.

µVision2 Control: Options – **Lx51** Misc – Misc Controls – enter the control.

Description: The **PURGE** control allows you to remove the complete debug information contained in the input files from the listing file **and** the object output file. **PURGE** has the same effect as specifying **NOCOMMENTS**, **NOLINES**, **NOPUBLICS** and **NOSYMBOLS**. The debug information is only required for program debugging and has no influence on the executable code. If you want to exclude line number information just from the listing file you have to use the **PRINTCONTROLS** control.

See Also: **NOCOMMENTS**, **NOLINES**, **NOPUBLICS**, **NOSYMBOLS**, **OBJECTCONTROLS**, **PRINTCONTROLS**

Example: `L251 MYPROG.OBJ PURGE`

9

WARNINGLEVEL

Restriction: This control is available in **LX51** and **L251** only.

Abbreviation: WL

Arguments: A number between 0 .. 2.

Default: WARNINGLEVEL (2)

µVision2 Control: Options – Lx51 Misc – Warnings – Warning Level.

Description: The **WARNINGLEVEL** control allows you to suppress linker warnings. Refer to “Warnings” on page 360 for a full list of the linker warnings.

| Warning Level | Description |
|--------------------|--|
| 0 | Disables almost all linker warnings. |
| 1 | Lists only those warnings that may generate incorrect code, including information about data type mismatches of total different types. |
| 2 (Default) | Lists all WARNING messages including warnings all data type mismatches. |

Example:

```
LX51 MYFILE.OBJ WL (1)
```

Example Listing File

The following example includes all optional sections of the listing file.

```

L251 LINKER/LOCATER V3.00                                09/06/2000  12:09:21  PAGE 1

L251 LINKER/LOCATER V3.00, INVOKED BY:                  The listing file shows the command
E:\L251.EXE MEASURE.OBJ, MCOMMAND.OBJ, GETLINE.OBJ IXREF line that invoked the linker.

CPU MODE:      251 SOURCE MODE                          CPU mode, interrupt frame size,
INTR FRAME:    4 BYTES SAVED ON INTERRUPT              memory model and floating point
MEMORY MODEL:  SMALL WITH FLOATING POINT ARITHMETIC    arithmetic are listed.

INPUT MODULES INCLUDED:                                Object modules that were included
MEASURE.OBJ (MEASURE)                                  along with translator information
      COMMENT TYPE 0: C251 V3.00                       are listed.
MCOMMAND.OBJ (MCOMMAND)
      COMMENT TYPE 0: C251 V3.00
GETLINE.OBJ (GETLINE)
      COMMENT TYPE 0: C251 V3.00
C:\KEIL\C251\LIB\C2SFPS.LIB (?C_FPADD)
      COMMENT TYPE 0: A251 V3.00
:
ACTIVE MEMORY CLASSES OF MODULE:  MEASURE (MEASURE)    LX51 and L251 list an overview of all
                                                         memory classes in used.

BASE      START      END      MEMORY CLASS
=====
FF0000H   FF0000H   FFFFFFFH   CODE
000000H   000000H   00007FH   DATA
000000H   000000H   0000FFH   IDATA
010000H   010000H   01FFFFFFH  XDATA
000020H.0 000020H.0 00002FH.7  BIT
000000H   000000H   00FFFFFFH  EDATA

MEMORY MAP OF MODULE:  MEASURE (MEASURE)              The memory map is included
                                                         You can disable the memory map
                                                         using the NOMAP control.

START     STOP      LENGTH   ALIGN  RELOC   MEMORY CLASS  SEGMENT NAME
=====
000000H   000007H   000008H   ---   AT..    DATA         "REG BANK 0"
000008H   00000FH   000008H   ---   AT..    DATA         "REG BANK 1"
000010H   000010H   000001H   BYTE  UNIT    DATA         ?DT?GETCHAR
000011H   00001FH   00000FH   BYTE  UNIT    IDATA        _IDATA_GROUP_
000020H.0 000020H.2 000000H.3  BIT   UNIT    BIT          ?BI?MEASURE
000020H.3 000020H.3 000000H.1  BIT   UNIT    BIT          ?BI?GETCHAR
000020H.4 000021H.6 000001H.3  BIT   UNIT    BIT          _BIT_GROUP_
000022H   000039H   000018H   BYTE  UNIT    DATA         ?DT?MEASURE
00003AH   000065H   00002CH   BYTE  UNIT    DATA         _DATA_GROUP_
000066H   000165H   000100H   BYTE  UNIT    EDATA         ?STACK
010000H   011FF7H   001FF8H   BYTE  UNIT    XDATA        ?XD?MEASURE
FF0000H   FF0002H   000003H   ---   OFFS..  CODE         ?CO?START251?3
FF0003H   FF0008H   000006H   BYTE  UNIT    CODE         ?PR?GETCHAR?UNGETCHAR
:

OVERLAY MAP OF MODULE:  MEASURE (MEASURE)            An overlay map is listed after the
                                                         memory map. The overlay map shows
                                                         the call tree of your application.

FUNCTION/MODULE                                     BIT_GROUP  DATA_GROUP  IDATA_GROUP
--> CALLED FUNCTION/MODULE                         START STOP  START STOP  START STOP
=====
TIMER0/MEASURE                                     -----
--> SAVE_CURRENT_MEASUREMENTS/MEASURE

*** NEW ROOT *****

?C_C251STARTUP
--> MAIN/MEASURE

```

```

MAIN/MEASURE          ----- 003AH 003CH 0011H 001FH
--> CLEAR_RECORDS/MEASURE
--> PRINTF/PRINTF
--> GETLINE/GETLINE
--> TOUPPER/TOUPPER
--> READ_INDEX/MEASURE
--> GETKEY/_GETKEY
--> MEASURE_DISPLAY/MCOMMAND
--> SET_TIME/MCOMMAND
--> SET_INTERVAL/MCOMMAND

PRINTF/PRINTF          20H.4 21H.4 0049H 0064H -----
--> PUTCHAR/PUTCHAR

GETLINE/GETLINE        ----- 003DH 0040H -----
:
PUBLIC SYMBOLS OF MODULE: MEASURE (MEASURE)
                        VALUE      CLASS  TYPE      PUBLIC SYMBOL NAME
=====
00000021H.2 BIT      BIT      ?C?ATOFFIRSTCALL
00FF0F5CH CODE      ---      ?C?CASTF
00FF12D3H CODE      ---      ?C?CCASE
00000020H.3 BIT      BIT      ?C?CHARLOADED
00FF186DH CODE      ---      _SSCANF
:
SYMBOL TABLE OF MODULE: MEASURE (MEASURE)
                        VALUE      REP      CLASS  TYPE      SYMBOL NAME
=====
---      MODULE      ---      ---      MEASURE
00000020H.2 PUBLIC  BIT      BIT      MEASUREMENT_INTERVAL
00000036H PUBLIC  DATA    ---      INTERVAL
00000020H.1 PUBLIC  BIT      BIT      MDISPLAY
00000035H PUBLIC  DATA    BYTE     INTCYCLE
00000033H PUBLIC  DATA    WORD     SAVEFIRST
:
00FF000EH BLOCK  CODE      ---      LVL=0
00FF000EH LINE  CODE      ---      #87
00FF000EH LINE  CODE      ---      #88
:
---      BLOCKEND  ---      ---      LVL=0
:
INTER-MODULE CROSS-REFERENCE LISTING
NAME . . . . . CLASS  MODULE NAMES
=====
?C?ATOFFIRSTCALL . . . . . BIT      ?C_ATOF  SCANF
?C?CASTF . . . . . CODE     ?C_CASTF MCOMMAND
?C?CCASE . . . . . CODE     ?C_CCASE PRINTF SCANF
?C?CHARLOADED. . . . . BIT      GETCHAR UNGETC
?C?COPY2 . . . . . CODE     ?C_COPY2 MCOMMAND MEASURE
?C?FCASTC. . . . . CODE     ?C_FCAST ?C_ATOF MCOMMAND
?C?FCASTI. . . . . CODE     ?C_FCAST
?C?FCASTL. . . . . CODE     ?C_FCAST
?C?FPADD . . . . . CODE     ?C_FPADD ?C_ATOF ?C_FPCONVERT
?C?FPATOF. . . . . CODE     ?C_ATOF  SCANF
?C?FPCMP . . . . . CODE     ?C_FPCMP
?C?FPCMP3. . . . . CODE     ?C_FPCMP MCOMMAND
?C?FPCONVERT . . . . . CODE     ?C_FPCONVERT PRINTF
:

```

A list of all public symbols is printed. This list can be disabled using the NOPUBLICS or PRINTCONTROLS control.

The symbol table lists the complete debug information of your project.

You can use the PRINTCONTROL control to exclude part of the symbol information from the listing.

The IXREF control instructs Lx51 to include a cross reference table.

Output File Controls

The linker/locator either generates absolute object files or banked object files. Absolute object files contain no relocatable information or external references. Absolute object files can be loaded into debugging tools or may be converted into Intel HEX files for PROM programming by **OHx51** Object-Hex Converter.

Banked object files generated by the **BL51** linker/locator must be converted by the **OC51** Banked Object File Converter into absolute object files (one for each bank) to convert them into Intel HEX files by the **OH51** Object-Hex Converter.

The generated object module may contain debugging information if the linker/locator is so directed. This information facilitates symbolic debugging and testing. You may use the linker controls to suppress debugging information in the object file. The following table provides an overview of the controls that control information in the output file. For a detailed description of each control refer to the page specified in the table.

| BL51 | LX51, L251 | Page | Description |
|-----------------------|-----------------------|------|---|
| - | ASSIGN | 322 | Defines public symbols on the command line. |
| IBANKING | - | 323 | Generate bank switch code for Infineon TV TEXT devices SDA555x and SDA30C16x. |
| NAME | NAME | 323 | Specifies a module name for the object file. |
| NOAJMP | NOAJMP | 325 | Generate bank switch code without AJMP instructions. |
| NOINDIRECTCALL | NOINDIRECTCALL | 327 | Do not generate by default bank switch code for indirectly called functions. |
| NOJMPTAB | - | 328 | Do not generate bank switch code. |
| - | NOTYPE | 327 | Specifies a module name for the object file. |
| NODEBUGLINES | OBJECTCONTROLS | 325 | Excludes debug information from the object file. |
| NODEBUGPUBLICS | | 330 | |
| NODEBUGSYMBOLS | | | |

9

ASSIGN

Restriction: This control is available in **LX51** and **L251** only.

Abbreviation: AS

Arguments: **ASSIGN** (*symname* (*value*) [, ...])

Default: None

µVision2 Control: Options – **Lx51** Misc – Assign.

Description: **ASSIGN** defines a PUBLIC symbol with a numeric value at Lx51 linker/locator level. The PUBLIC symbol is handled as a number without a specific memory class and matches with an unresolved external symbol with the same name.

Example:

```
L251 MYFILE.OBJ ASSIGN (FUNC (0x2000), BITVAR (20H.2))
```

In this example the public symbols FUNC and BITVAR are defined. The value 0x2000 is given as value for FUNC. The value 20H.2 is used as bit-address for BITVAR.

IBANKING

Restriction: This control is available in **BL51** only.

Abbreviation: **IB**

Arguments: **IBANKING** [(*bank_sfr_address*)]

Default: The default *bank_sfr_address* is 0x94. This is also the SFR address for the support Infineon devices.

µVision2 Control: Options – Lx51 Misc – Misc Controls – enter the control.

Description: With the **BL51** linker/locater control **IBANKING** the linker uses the on-chip code banking hardware of the Infineon SDA30C16x/26x and SDA555x TV TEXT devices. The **BL51** linker/locater places automatically all code segments in the bank area, which do not have the ?CO? prefix or ?CO postfix. Segments with a ?CO prefix or postfix are placed into the common area.

The module **L51_BANK.A51** is not used when the control **IBANKING** is used. The **BL51** linker/locater generates in this operation mode a jump table with the following format:

```
MOV    bank_sfr, #BANK_NUMBER
LJMP   target
```

NOTE

*When you are using this directive, you need also special C51 run-time libraries. Please contact **Keil Software** to obtain these C51 run-time libraries.*

See Also: **NOAJMP, NOINDIRECTCALL, NOJMPTAB, BANKAREA**

Example:

```
BL51 BANK0 {MODULA.OBJ}, BANK1 {MODULB.OBJ} IBANKING
BL51 BANK0 {MODULA.OBJ}, BANK1 {MODULB.OBJ} IB (80H)
```

NAME

Abbreviation: NA

Arguments: NAME (*modulename*)

Default: Module name of the first object file in the input list is used.

µVision2 Control: Options – Lx51 Misc – Misc Controls – enter the control.

Description: Use the **NAME** control to specify a module name for the absolute object module that the **BL51** linker/locator generates. The **NAME** control may be accompanied by the module name (in parentheses) that you want to assign. If no module name is specified with the **NAME** control, the name of the first input module is used for the module name.

NOTE

The module name specified with the NAME control is not the filename of the absolute object file. The module name is stored in the object module file and may be accessed only by a program that reads the contents of that file.

Example:

```
BL51 MYPROG.OBJ TO MYPROG.ABS NAME (BIGPROG)
```

In this example **BIGPROG** is the module name stored in the object file.

NOAJMP

Abbreviation: NOAJ

Default: The **Lx51** linker/locater generates for code banking applications an inter-bank jump table. This bank switch table is used for jumps into a code bank from a different code bank or the common area. Depending on the table size, the linker uses AJMP or LJMP instructions within this bank switch table.

µVision2 Control: Options – **Lx51** Misc – Misc Controls – enter the control.

Description: With the **NOAJMP** control you can disable the AJMP instruction in the inter-bank jump table. This option is required for 8051 derivatives that are not supporting the AJMP instruction.

See Also: **IBANKING, NOINDIRECTCALL, NOJMPTAB, BANKAREA**

Example: `BL51 MYPROG.OBJ NOAJMP`

9

**NODEBUGLINES, NODEBUGPUBLICS,
NODEBUGSYMBOLS**

Restriction: This control is available in **BL51 only**. For **LX51** and **L251** use the **OBJECTCONTROLS** control.

Abbreviation: **NODL, NODP, NODS**

Default: Include complete debug information in the output file.

µVision2 Control: Options – **Lx51 Misc** – Misc Controls – enter the control.

Description: The **NODEBUGLINES** control directs the **BL51** linker/locator to exclude line number information from the output object file.

The **NODEBUGPUBLICS** control excludes public symbol information from the output object file.

The **NODEBUGSYMBOLS** control excludes local symbol information from the output object file.

NOTE

Line number and symbol information in the absolute object file is used for symbolic debugging in the µVision2 debugger or in-circuit emulator. If you exclude debug information, source level debugging of your program is no longer possible.

See Also: **NOLINES, NOPUBLICS, NOSYMBOLS, OBJECTCONTROLS, PRINTCONTROLS**

Example: `BL51 MYPROG.OBJ NODEBUGLINES NODEBUGSYMBOLS`

NOINDIRECTCALL

Abbreviation: NOIC

Default: In code banking applications, the **Lx51** linker/locater inserts an interbank CALL for each function that is indirectly called via a function pointer. This is done (by the linker) to ensure that functions which are invoked through a function pointer are available to all code banks.

µVision2 Control: Options – **Lx51** Misc – Misc Controls – enter the control.

Description: The **NOINDIRECTCALL** control allows you to disable the generation of interbank CALLs (for indirect function calls). This directive is useful if your application uses tables that contain pointers to functions and if you ensure that these indirect function calls never cross a code bank.

See Also: **IBANKING, NOAJMP, NOJMPTAB, BANKAREA**

Example: `BL51 MYPROG.OBJ NOINDIRECTCALL`

NOJMPTAB

Restriction: This control is available in **BL51 only**.

Abbreviation: **NOJT**

Default: The **Lx51** linker/locator generates for code banking automatically an inter-bank jump table or bank switch table. For each function that is located in a code bank and is called from a different code bank or the common area the linker inserts a bank switch code into the inter-bank jump table redirects the function call to this table.

µVision2 Control: Options – **Lx51** Misc – Misc Controls – enter the control.

Description: When the **NOJMPTAB** control is stated, BL51 no longer inserts inter-bank calls for program calls. This feature is implemented to use the user-defined bank switch mechanism for code banking. The **NOJMPTAB** directive modifies the following features of **BL51**:

- The linker no longer needs the bank switch configuration file: `L51_BANK.OBJ`.
- The linker does not modify any jump call instructions.

The linker does not generate any warnings if a jump/call is made to another bank. The user must ensure that the proper bank is selected before a call is made since the BL51 linker/locator no longer selects the bank automatically.

See Also: **IBANKING, NOAJMP, NOINDIRECTCALL, BANKAREA**

Example: `BL51 MYPROG.OBJ NOJMPTAB`

NOTYPE

Restriction: This control is available in **LX51** and **L251** only.

Syntax: **NOTYPE**

Abbreviation: **NOTY**

Default: Include complete type information in the output file.

µVision2 Control: Options – **Lx51** Misc – Misc Controls – enter the control.

Description: The **NOTYPE** control removes symbol type information for debug symbols from the output file. The symbol type information is only required for program debugging and has no influence on the executable code.

NOTE

Symbol type information in the absolute object file is used for symbolic debugging in the µVision2 debugger or in-circuit emulator. The Cx51 compiler generates complete symbol information up to structure members and parameter passing values. If you exclude symbol type information, you might not be able to display variables during debugging.

See also: **OBJECTCONTROL, PURGE**

Example: `LX51 file1.obj NOTYPE`

9

OBJECTCONTROLS

Restriction: This control is available in **LX51** and **L251** only.

Abbreviation: **OC**

Arguments: **OBJECTCONTROLS** (*subcontrol*[, ...])

Default: Include complete debug information in the output file.

µVision2 Control: Options – **Lx51** Misc – Misc Controls – enter the control.

Description: The **OBJECTCONTROLS** control allows you to remove specific debug information from the object output file. The *subcontrol* option can be one or more of the following parameters:

| <i>subcontrol</i> | Removes from the object output file ... |
|--------------------------|---|
| <u>N</u>OCOMMENTS | ... comment records. |
| <u>N</u>OLINES | ... line number information. |
| <u>N</u>OPUBLICS | ... public symbol information. |
| <u>N</u>OSYMBOLS | ... local symbol information. |
| <u>P</u>URGE | ... complete debug information. |

See Also: **NOCOMMENTS, NOLINES, NOPUBLICS, NOSYMBOLS, OBJECTCONTROLS, PURGE**

Example: `LX51 MYPROG.OBJ OBJECTCONTROLS (NOCOMMENTS)`

Segment and Memory Location Controls

9

The **Lx51** linker/locator allows you to specify the size of the different memory areas or memory classes, the order of the segments within the different memory areas, and the location or absolute memory address of different segments. Also the size of segments can be manipulated and specific memory areas can be excluded from being used. These segment manipulations are performed using the following controls.

| BL51 | LX51, L251 | Page | Description |
|--------------------------|--------------------------|------|---|
| <u>BANKAREA</u> | <u>BANKAREA</u> | 332 | Specifies the address range where the code banks are located. |
| <u>BANKx</u> | – | 333 | Locates and orders segments in code bank x (where x is a code bank from 0 to 31). |
| <u>BIT</u> | – | 334 | Locates and orders BIT segments. |
| – | <u>CLASSES</u> | 336 | Specifies a physical address range for segments in a memory class. |
| <u>CODE</u> | – | 338 | Locates and orders CODE segments. |
| <u>DATA</u> | – | 339 | Locates and orders DATA segments. |
| <u>IDATA</u> | – | 340 | Locates and orders IDATA segments. |
| <u>NOSORTSIZE</u> | <u>NOSORTSIZE</u> | 341 | Disable size sorting for segments before allocating the memory. |
| <u>PDATA</u> | – | 341 | Specifies start address for PDATA segments. |
| <u>PRECEDE</u> | – | 343 | Locates and orders segments that should precede others in DATA memory. |
| <u>RAMSIZE</u> | – | 344 | Specifies size of DATA and IDATA memory. |
| – | <u>RESERVE</u> | 345 | Reserves memory ranges and prevents the linker from using these memory areas. |
| – | <u>SEGMENTS</u> | 346 | Defines physical memory addresses and orders for specified segments. |
| – | <u>SEGSIZE</u> | 348 | Modifies the size for a specific segment. |
| <u>STACK</u> | – | 349 | Locates and orders STACK segments. |
| <u>XDATA</u> | – | 350 | Locates and orders XDATA segments. |

The **Lx51** linker/locator locates segments in according their memory class and follows a predefined order of precedence. The standard allocation algorithm usually produces the best workable solution and does not requiring you to enter any segment names on the command line. The controls described in this section allow you to define the physical memory layout of your target system and more closely control the location of segments within the different memory classes. Refer to “Locating Programs to Physical Memory” on page 273 for examples on how to define the available memory in your **x51** system.

9

BANKAREA**Abbreviation:** BA**Arguments:** **BANKAREA** (*start_address, end_address*)**Default:** None**µVision2 Control:** Options – Target – Code Banking – Bank Area.

Description: Use the **BANKAREA** control to specify the starting and ending address of the area where the code banks will be located. The addresses specified should reflect the actual address where the code bank ROMs are physically mapped. All segments that are assigned to a bank will be located within this address range unless they are defined differently using the **BANKx** control. Refer to “Bank Switching” on page 293 for more information about the code banking controls.

See Also: **BANKx****Example:**

```
LX51 COMMON{C_ROOT.OBJ}, BANK0{C_BANK0.OBJ},  
      BANK0{C_BANK0.OBJ}, BANK1{C_BANK1.OBJ},  
      BANK2{C_BANK2.OBJ} TO MYPROG.ABS &  
      BANKAREA(8000H,0FFFFH)
```

BANK x

Restriction: This control is available in **BL51 only**. For **LX51** and **L251** use the **SEGMENTS** control.

Abbreviation: **B0, B1, B2, ... B30, B31**

Arguments: **BANK x** (*start_address* [*segname* [(*address*)], ...,])

µVision2 Control: Options – BL51 Misc – Misc Controls – enter the control.

Description: Use the **BANK x** control to specify a code bank for segments (x in **BANK x** is replaced by a bank number). Refer to “Bank Switching” on page 293 for more information about the code banking controls.

Segments are located in the specified code bank starting at *start_address* or address 0000h if *start_address* is not specified. If an *address* is specified the segment referred by *segname* will be located at this address.

If you allocate a constant segment of a **Cx51** program into a code bank, you must manually ensure that the proper code bank is used when accessing that constant data. You can do this with the **switchbank** function that is defined in the **L51_BANK.A51** module. “BANK_EX2 – Banking with Constants” on page 407 shows a complete example program.

See Also: **BANKAREA, CODE**

Example: This example will locate the segment `?PR?FUNC1?A` that belongs to the C function `func1` in module “**A.C**” into code bank 1 starting at address 0x8000. The segment `?PR?FUNC1?A` will be located at address 0x8200.

```
BL51 COMMON{A.OBJ}, BANK0{B.OBJ}
      BANK1(0x8000, ?PR?FUNC1?A, ?PR?FUNC2?B(0x8200))
```

9

BIT

Restriction: This control is available in **BL51 only**. For **LX51** and **L251** use the **CLASSES** and **SEGMENTS** control.

Abbreviation: **BI**

Arguments: **BIT** ([*start_address*] [*segname* [(*address*)] [, ...]])

µVision2 Control: Options – BL51 Locate – Bit.

Description: The **BIT** control allows you to specify:

- The starting address for segments placed in the bit-addressable internal data space
- The order of segments within the bit-addressable internal data space
- The absolute memory location of segments in the bit-addressable internal data space.

Addresses that you specify with the **BIT** control are bit addresses. Bit addresses 00h through 7Fh reference bits in DATA memory bytes from byte address 20h to 2Fh (16 bytes of 8 bits each, $16 \times 8 = 128 = 80h$). Bit addresses that are evenly divisible by 8 are aligned on a byte boundary. A DATA segment that is bit-addressable can be located with the BIT control; however, the bit address specified must be byte aligned, that means evenly divisible by 8.

See Also: **CODE, DATA, IDATA, XDATA**

Examples: The following example specifies that relocatable BIT segments be located at or after bit address 48 decimal (30 hex) which is equivalent to byte address 26H.0 in the data memory:

```
BL51 MYPROG.OBJ BIT(48)
```

or

```
BL51 MYPROG.OBJ BIT(0x30)
```

To specify the order for segments, you must include the segment names, separated by commas. The following example places the `?DT?A`, `?DT?B`, and `?DT?C` segments at the beginning of the bit-addressable DATA memory.

```
BL51 MYPROG.OBJ,A.OBJ,B.OBJ,C.OBJ BIT(?DT?A,?DT?B,?DT?C)
```

You may also specify the bit address for the segments. The following example places the `?DT?A` and `?DT?B` segments at `28h` and `30h`:

```
BL51 MYPROG.OBJ,A.OBJ,B.OBJ BIT(?DT?A(28h),?DT?B(30h))
```

CLASSES

Restriction: This control is available in **LX51** and **L251** only.

Abbreviation: **CL**

Arguments: **CLASSES** (*classname* (*range*[, ...]) [, ...])

Default: None

µVision2 Control: Options – **Lx51** Locate – User Classes.

Description: The **CLASSES** control specifies the physical address range for segments within a memory class. The **CLASSES** control provides an efficient way to define the physical memory layout. If the address limits for a memory class are not specified with the **CLASSES** control, the **Lx51** linker/locator uses the physical address limits of the memory class. The address ranges that are used are listed in the linker MAP file in the section **ACTIVE MEMORY CLASSES**. It is recommended to check this section of the MAP file, since it lists where the Lx51 linker/locator assumes memory in your target hardware. More information about “Locating Programs to Physical Memory” can be found on page 273.

With the **CLASSES** control the absolute address for segments with the relocation type **OFFS** can be modified. For more information on how to declare such segments refer to “Relocation Type” on page 108. The offset is specified as first address in the range field with a ‘\$’ prefix, for example: **CLASSES (CODE (\$0xFF8000, 0xFF8000 - 0xFFFFF))**. In this case all segments that are defined with the **OFFS** relocation type, are redirected to the address 0xFF8000. Typically the interrupt and reset vectors of a program are defined this way. In this way, you can quickly redirect these vectors, for example, when you are debugging programs with the Monitor-251 installed at address 0xFF0000.

A memory class can be copied into RAM for execution whereas the content is stored in the SROM memory class. In this case you must copy the memory class from ROM to RAM before execution. Empty brackets after the address range are used to store the content of a memory class within the address range of the SROM memory class, for example: **CLASSES (NCONST (0xE000 - 0xFFFF))[]**. Refer to “Use RAM for the 251 Memory Class NCONST” on page 292 for a program example that uses this feature.

See Also: **SEGMENTS**

Examples: The following example specifies the address range of the EDATA and CODE memory class:

```
L251 MYFILE.OBJ &
  CLASSES (EDATA (0 - 0x41F, 0x2000H - 0x3FFF),
           CODE (0xFF0000 - 0xFF7FFF))
```

This example defines the memory classes for a classic 8051 device:

```
LX51 MYFILE.OBJ
  CLASSES (IDATA (I:0-I:0xFF), XDATA (X:0-X:0xEFFF),
           CODE (C:0-C:0x7FFF, C:0xC000-C:0xFFFF))
```

In this example the user-defined memory class XDATA_FLASH is defined. Refer to “User-defined Class Names” on page 107 for more information.

```
LX51 MYFILE.OBJ
  CLASSES (XDATA_FLASH (X:0x8000-X:0xEFFF))
```

9

CODE

Restriction: This control is available in **BL51 only**. For **LX51** and **L251** use the **CLASSES** and **SEGMENTS** control.

Abbreviation: **CO**

Arguments: **CODE** (*[[address_range] [[segname [(address)] [, ...]]]*)

µVision2 Control: Options – BL51 Locate – Code Range, Code.

Description: The **CODE** control allows you to specify:

- The address range for segments placed in the **CODE** memory class or **CODE** memory space.
- The order of segments within the **CODE** space.
- The absolute memory location of segments in the **CODE** memory space.

See Also: **BIT, DATA, IDATA, XDATA**

Examples: The example below specifies that relocatable **CODE** segments be located in the address space 0 – 0x3FFF and 0x8000 – 0xFFFF:

```
BL51 MYPROG.OBJ CODE(0 - 0x3FFF, 0x8000 - 0xFFFF)
```

To specify the order for segments, you must include the names of the segments separated by commas. The following example will place the **?PR?FUNC1?A** and **?PR?FUNC2?A** segments at the beginning of the **CODE** memory:

```
BL51 A.OBJ CODE(?PR?FUNC1?A, ?PR?FUNC2?A)
```

You can also specify the memory location for a segment. The example below will place the **?PR?FUNC1?A** segment at **800h** and the **?PR?FUNC2?A** segment after at this segment:

```
BL51 A.OBJ CODE(?PR?FUNC1?A (0x800), ?PR?FUNC2?A)
```

DATA

Restriction: This control is available in **BL51 only**. For **LX51** and **L251** use the **CLASSES** and **SEGMENTS** control.

Abbreviation: **DA**

Arguments: **DATA** ([*start_address*] [*segname* [(*address*)] [, ...]])

µVision2 Control: Options – BL51 Locate – Data.

Description: The **DATA** control allows you to specify:

- The address range for segments placed in the directly-addressable DATA space.
- The order of segments within the DATA space.
- The absolute memory location of segments in the directly-addressable internal DATA space.

See Also: **BIT, CODE, IDATA, XDATA**

Examples: The example below specifies that relocatable DATA segments be located at or after address 48 decimal (30 hex) in the on-chip DATA memory:

```
BL51 MYPROG.OBJ DATA(48)
```

or

```
BL51 MYPROG.OBJ DATA(0x30)
```

To specify the order for segments, you must include the names of the segments separated by commas. The following example will place the **?DT?A**, **?DT?B**, and **?DT?C** segments at the beginning of the DATA memory:

```
BL51 A.OBJ,B.OBJ,C.OBJ DATA(?DT?A,?DT?B,?DT?C)
```

You can also specify the memory location. The example below will place the **?DT?A** and **?DT?B** segments at **28h** and **30h** in the DATA memory:

```
BL51 MYPROG.OBJ,A.OBJ,B.OBJ DATA(?DT?A(28h),?DT?B(30h))
```

IDATA

Restriction: This control is available in **BL51 only**. For **LX51** and **L251** use the **CLASSES** and **SEGMENTS** control.

Abbreviation: **ID**

Arguments: **IDATA** (*[start_address]* [*segname* (*[address]*) [*, ...*]])

µVision2 Control: Options – BL51 Locate – Idata.

Description: The **IDATA** control allows you to specify:

- The starting address for segments placed in the indirectly-addressable on-chip IDATA space.
- The order of segments within the IDATA space.
- The absolute memory location of segments in the IDATA memory space.

See Also: **BIT, CODE, DATA, XDATA**

Examples: The example below specifies that relocatable IDATA segments be located at or after address 64 decimal (40 hex) in the IDATA memory.

```
BL51 MYPROG.OBJ IDATA(64)
```

or

```
BL51 MYPROG.OBJ IDATA(0x40)
```

To specify the order for segments, you must include the names of the segments separated by commas. The following example places the **?ID?A**, **?ID?B**, and **?ID?C** segments at the beginning of the IDATA memory:

```
BL51 A.OBJ,B.OBJ,C.OBJ IDATA(?ID?A,?ID?B,?ID?C)
```

You may also specify the memory location. This example places the **?ID?A** and **?ID?B** segments at **30h** and **40h** in the on-chip IDATA memory:

```
BL51 MYPROG.OBJ,A.OBJ,B.OBJ IDATA(?ID?A(30h),?ID?B(40h))
```

NOSORTSIZE

Abbreviation: NOSO

Arguments: None

Default: The segments are sorted according their size before the Lx51 linker/locater allocates the memory space. This reduces typically the memory gaps that are required to fulfill the allocation requirements.

µVision2 Control: Options – Lx51 Misc – Misc Controls: enter the control.

Description: The **NOSORTSIZE** control allows you disable the sorting algorithm. In this case the linker allocates the memory in the order the segments appear in the input files.

Example: `BL51 MYPROG.OBJ NOSORTSIZE`

PDATA

Restriction: This control is available in **BL51 only**. For **LX51** and **L251** use the **CLASSES** and **SEGMENTS** control.

Abbreviation: None

Arguments: **PDATA** (*address*)

µVision2 Control: Options – BL51 Locate – Pdata.

Description: The **PDATA** control allows you to specify the starting address in external data space for **PDATA** segments. You must enter the starting address immediately following the **PDATA** control on the command line. The address must be enclosed in parentheses.

In addition to specifying the starting address for **PDATA** segments on the linker command line, you must also modify the startup code stored in **STARTUP.A51** to indicate that **PDATA** segments are located at 8000h. Refer to the *C51 User's Guide* for more information about **PDATA** and **COMPACT** model programming.

See Also: **XDATA**

Example: This example specifies that **PDATA** segments are to be located starting at address 8000 hex in the external data memory.

```
BL51 MYPROG.OBJ PDATA(0x8000)
```

PRECEDE

Restriction: This control is available in **BL51 only**. For **LX51** and **L251** use the **CLASSES** and **SEGMENTS** control.

Abbreviation: **PC**

Arguments: **PRECEDE** (*segname* [(*address*)] [, ...])

µVision2 Control: Options – BL51 Locate – Precede.

Description: The **PRECEDE** control allows you to specify segments that lie in the on-chip DATA memory that should precede other segments in that memory space. Segments that you specify with this control are located after the **BL51** linker/locator has located register banks and any absolute **BIT**, **DATA**, and **IDATA** segments, but before any other segments in the internal DATA memory.

See Also: **DATA, STACK**

Examples: You specify segment names with the **PRECEDE** control. Segment names must be separated by commas and must be enclosed in parentheses immediately following the **PRECEDE** control. For example:

```
BL51 MYPROG.OBJ,A.OBJ,B.OBJ PRECEDE(?DT?A,?DT?B)
```

The segments that you specify are located at the lowest available memory location in the DATA memory in the order that you specify. You may also specify the memory location of the segments you specify with the **PRECEDE** control. The example below places the **?DT?A** and **?DT?B** segments at **09h** and **13h** in the DATA memory:

```
BL51 A.OBJ,B.OBJ PRECEDE(?DT?A(09h),?DT?B(13h))
```

9

RAMSIZE

Restriction: This control is available in **BL51 only**. For **LX51** and **L251** use the **CLASSES** and **SEGMENTS** control.

Abbreviation: **RS**

Arguments: **RAMSIZE (value)**

Default: **RAMSIZE (128)**

µVision2 Control: Generated from the Device Database Information.

Description: The **RAMSIZE** control allows you to specify the number of bytes of **DATA** and **IDATA** memory that are available in your target 8051 derivative. The number of bytes must be a number between 64 and 256. This number must be enclosed in parentheses.

NOTE

*In the device data sheets the size of the DATA and IDATA memory is usually referred as on-chip RAM size. However, several new 8051 devices have additional on-chip RAM that is mapped into the XDATA space. If the on-chip RAM size of your 8051 derivative is more than 256 bytes, then your device has most likely additional RAM that is accessed as XDATA memory. In this case use **RAMSIZE (256)** to enable the complete DATA and IDATA address space and define the additional on-chip RAM with the **XDATA** control.*

Example:

```
BL51 MYPROG.OBJ RAMSIZE (256)
```

This example specifies there are 256 bytes of on-chip memory for **DATA** and **IDATA** that may be allocated by the linker.

RESERVE

Restriction: This control is available in **LX51** and **L251** only.

Abbreviation: **RE**

Arguments: **RESERVE** (*range* [, ...])

Default: no memory areas are reserved.

µVision2 Control: Options – **Lx51** Misc – Reserve.

Description: The **RESERVE** directive allows you to prevent **Lx51** from locating segments in the specified address ranges of the physical memory. The **Lx51** linker/locator will not use all memory address within the specified address range.

If an absolute segment uses a reserved memory area, a warning message is generated. Refer to “Error Messages” on page 360 for more information about this directive.

See Also: **CLASSES, SEGMENTS**

Example:

```
L251 MYPROG.OBJ RESERVE(0x200 - 0x3FFF,  
0xFF8000H - 0xFFBFFFH)
```

9

SEGMENTS

Restriction: This control is available in **LX51** and **L251** only.

Abbreviation: SE

Arguments: SEGEMENTS (*segname* [(*address*)] [, ...])

µVision2 Control: Options – Lx51 Locate – User Segments.

Description: The **SEGMENTS** control allows you to specify:

- The absolute memory location of a segment. The absolute address can be either a start or an end address.
- The order of segments within the memory. Segments may be located as first or last segment. Segments defined in the **SEGMENTS** control are allocated sequentially. By default, the first segment is located at the lowest possible address range (specified with the **CLASSES** control). Subsequent segments are located at ascending addresses. When you are using the keyword **LAST** in the *address* field, then the segment is located as last segment for this memory class.
- A segment can be executed in RAM whereas the content is stored in the ROM memory class. Such segments need to be copied from ROM to RAM before execution. You can specify both the ROM address that stores the content and the RAM address that is used to address the segment during program execution. This syntax is:

SEGMENTS Syntax for Store in ROM and Executed in RAM

SEGMENTS (*segment_name*(*exec_address*)[*store_address*], ...)

exec_address specifies the execution address for the segment.
store_address is the address where the segment is stored in ROM.

SEGMENTS (*segment_name*(*exec_address*)[], ...)

If you specify empty brackets [] for the *store_address* the segment will be stored within the address range of the **SROM** memory class.

SEGMENTS (*segment_name*(*exec_address*)!*store_address*], ...)

Lx51 does not reserve the space for execution, if the exclamation mark is given before the *store_address*. This is useful, if the segment content is copied over RAM that is temporarily used, for example the stack area.

SEGMENTS (*segment_name*(*exec_address*)![], ...)

If not *store_address* is given the segment is stored within the range of the **SROM** memory class. Also here not space is reserved for execution.

See Also: CLASSES, RESERVE, SEGSIZE

Examples: The example below will place the `?DT?A` and `?DT?B` segments at `28h` and `30h` in the DATA memory:

```
LX51 A.OBJ,B.OBJ SEGMENTS (?DT?A(D:0x28),?DT?B(D:0x30))
```

To specify the order for segments, you must include the names of the segment separated by commas. The following example places the `?DT?A`, `?DT?B`, and `?DT?C` segments at the beginning of the memory class. If these segments belong to the DATA memory class they will be placed as first segments in the DATA memory class.

```
L251 A.OBJ,B.OBJ,C.OBJ SEGMENTS(?DT?A,?DT?B,?DT?C)
```

A segment can be located to a code bank. The next example locates the segment `?PR?FUNC2?B` into code bank 0 and the segment `?PR?FUNC1?A` to address `0x8000` in code bank 1.

```
L251 BANK0 {A.OBJ}, BANK1 {B.OBJ}
      SEGMENTS(?PR?FUNC2?B (B0:), ?PR?FUNC1?A (B1:0x8000))
```

You can also specify that a segment should be placed as last segment in a memory class by using the `LAST` keyword as address specification. The following example places the segment `?DT?A` as last segment in the DATA memory class:

```
LX51 A.OBJ,B.OBJ,C.OBJ SEGMENTS(?DT?B(LAST))
```

The prefix `^` before the address specifies the end address for a segment. The following command places the segment `?PR?SUM?B` in memory so that it ends at address `0xFF8000`.

```
L251 A.OBJ,B.OBJ SEGMENTS (?PR?SUM?B(^0xFF8000))
```

Next, the segment `?PR?FUNC1?A` is assigned an execution address of `0x4000` and a storage address of `0xFF8000`.

```
L251 A.OBJ SEGMENTS (?PR?FUNC1?A(0x4000)[0xFF8000])
```

The last example uses only an exclamation point as *store_ address*. This means that no memory is reserved at address `0x2000` and the section will be stored within the address range of the SROM memory class.

```
L251 A.OBJ SEGMENTS (?PR?FUNC1?A(0x2000)[!])
```

9

SEGSIZE

Restriction: This control is available in **LX51** and **L251** only.

Abbreviation: **SEGSIZE**

Arguments: **SEGSIZE** (*segname* (*size*) [, ...])

µVision2 Control: Options – **Lx51** Misc – Misc Controls: enter the control.

Description: The **SEGSIZE** directive allows you to specify the memory space used by a segment. For **BIT** segments the *size* may be specified in bits with the „,“ operator. The *segname* is any segment contained in the input modules.

The *size* specifies the change of the segment size or segment length. There are three ways of specifying this value:

- ‘+’ indicates that the value should be added to the current segment length.
- ‘-’ indicates that the value should be subtracted from the current segment length.
- No sign indicates that the value should become the new segment length.

See Also: **SEGMENTS**

Example: `L251 MYPROG.OBJ SEGSIZE (?STACK (+200H))`

STACK

Restriction: This control is available in **BL51 only**. For **LX51** and **L251** use the **CLASSES** and **SEGMENTS** control.

Abbreviation: **ST**

Arguments: **STACK** (*segname* [(*address*)] [, ...])

µVision2 Control: Options – BL51 Locate – Stack.

Description: The **STACK** control locates segments in the uppermost IDATA memory space. The segments specified will follow all other segments in the internal data memory space.

Both, the **Cx51** compiler and the PL/M-51 compiler generate a stack segment named **?STACK** which is automatically located at the top of the IDATA memory. The stack pointer is initialized by the startup code to point to the start of this segment. All return addresses and data that are pushed are stored in this memory area. It is not necessary to specifically locate this **?STACK** segment. The **STACK** control is usually used with assembly programs which might have several stack segments.

NOTE

Use extreme caution when relocating the ?STACK segment. It might result in a target program that does not run since data or idata variables are corrupted.

See Also: **DATA, IDATA, PRECEDE**

Examples: The segments that you specify are located at the highest available memory location in the internal data memory in the order that you specify, for example:

```
BL51 MYPROG.OBJ,A.OBJ,B.OBJ STACK (?DT?A,?DT?B)
```

You can also specify the memory location. This example places the **?DT?A** and **?DT?B** segments at **69h** and **73h**:

```
BL51 MYPROG.OBJ,A.OBJ,B.OBJ STACK (?DT?A(69h),?DT?B(73h))
```

XDATA

Restriction: This control is available in **BL51 only**. For **LX51** and **L251** use the **CLASSES** and **SEGMENTS** control.

Abbreviation: **XD**

Arguments: **XDATA** (*address_range* [*segname* [(*address*)] [, ...]])

µVision2 Control: Options – BL51 Locate – Xdata Range, Xdata.

Description: The **XDATA** control allows you to specify:

- The starting address for segments placed in the external data space
- The order of segments within the external data space
- The absolute memory location of segments in the external data space.

See Also: **BIT, CODE, DATA, IDATA, PDATA**

Examples: The example below specifies that relocatable **XDATA** segments be located in the address space 0 – 0x3FF and 0xF800 – 0xFFFF:

```
BL51 MYPROG.OBJ CODE(0 - 0x3FF, 0xF800 - 0xFFFF)
```

To specify the order for segments, you must include the names of the segments separated by commas. The following example will place the **?XD?MOD1** and **?XD?MOD2** segments at the beginning of the **XDATA** memory:

```
BL51 MOD1.OBJ,MOD2.OBJ CODE(?XD?MOD1, ?XD?MOD2)
```

You can also specify the memory location for a segment. The example below will place the **?XD?MOD1** segment at **800h**:

```
BL51 MOD1.OBJ,MOD2.OBJ CODE(?XD?MOD1 (0x800))
```

High-Level Language Controls

The **Lx51** linker/locator provides controls that have to do with the high-level languages **Cx51** and **PL/M-51** and the real-time operating systems **RTXx51**. For example, you can control whether or not the **Lx51** linker/locator includes automatically the run-time library and whether or overlays the local variable areas of C and PL/M-51 functions.

The following table provides an overview of these controls. For a detailed description of each control refer to the page specified in the table.

| BL51 | LX51, L251 | Page | Description |
|--|--|-------------|---|
| <u>N</u>ODEFAULT <u>L</u>IBRARY | <u>N</u>ODEFAULT <u>L</u>IBRARY | 352 | Excludes modules from the run-time libraries. |
| <u>N</u>OOVERLAY | <u>N</u>OOVERLAY | 353 | Prevents overlaying or overlapping local bit and data segments. |
| <u>O</u>VERLAY | <u>O</u>VERLAY | 354 | Lets you change call references between functions and segments for data overlaying program flow analysis. |
| <u>R</u>ECURSIONS | <u>R</u>ECURSIONS | 356 | Allows you to analyze the call tree of complex recursive applications. |
| <u>R</u>EGFILE | <u>R</u>EGFILE | 356 | Specifies the name of the generated file to contain register usage information. |
| – | RTX251 | 358 | Includes support for the RTX-251 full real-time kernel. |
| RTX51 | RTX51 | 358 | Includes support for the RTX-51 full real-time kernel. |
| RTX51TINY | RTX51TINY | 358 | Includes support for the RTX-51 tiny real-time kernel. |
| <u>S</u>PEEDOVL | – | 359 | Ignore during the overlay analysis references from constant segments to program code. |

9

NODEFAULTLIBRARY**Abbreviation:** NLIB**Arguments:** None**Default:** The run-time libraries of **Cx51**, **RTXx51**, and PL/M-51 are searched to resolve external references in your C or PL/M programs.

The path of the run-time libraries can be set for BL51 and LX51 with the **C51LIB** environment variable and for L251 with the **C251LIB** environment variable. This variable is defined with the SET command that is typically entered in the AUTOEXEC.BAT batch file as shown below:

```
SET C51LIB=C:\KEIL\C51\LIB
```

In μ Vision2 the path for run-time libraries can be specified in the dialog **Project – File Extensions, Books and Environment** under environment setup – LIB folder.

If no environment variable is set, the linker tries to locate the libraries in: *path_of_the_EXE_file*.\LIB\. In a typical installation of the tool chain this sets the correct path for the run-time libraries to \C51\LIB\ or \C251\LIB. These folders contain the run-time libraries for the **Cx51** compiler and the **RTXx51** real-time operating system.

The libraries that are automatically searched depend on the memory model and floating-point requirements of your application. For more information refer to the *Cx51 Compiler User's Guide*.

 μ Vision2 Control: Options – Lx51 Misc – Misc Controls: enter the control.**Description:** Use the **NODEFAULTLIBRARY** control to prevent the **Lx51** linker/locator from automatically including run-time libraries.**Example:**

```
BL51 MYPROG.OBJ NODEFAULTLIBRARY
```

NOOVERLAY

Abbreviation: NOOL

Arguments: None

Default: The Lx51 linker/locater is analyzing your program and overlays the segments of local variables and function arguments.

µVision2 Control: Options – Lx51 Misc – Misc Controls: enter the control.

Description: The **NOOVERLAY** control disables the overlay analysis and the data overlaying. When this control is specified, the **Lx51** linker/locator does not overlay the data space of local variables and function arguments.

Examples: `LX51 MYPROG.OBJ NOOVERLAY`

9

OVERLAY**Abbreviation:** OL

Arguments: **OVERLAY** (*sfname* { ! | ~ } *sfname* [, ...])
OVERLAY (*sfname* { ! | ~ } (*sfname*, *sfname* [, ...])[, ...])
OVERLAY (*sfname* ! *)
OVERLAY (* ! *sfname*)

Default: The Lx51 linker/locator analyses the call tree of your program and assumes normal program flow without indirect calls via function pointers.

µVision2 Control: Options – Lx51 Misc – Overlay.

Description: The **OVERLAY** control allows you to modify the call tree as it is recognized by the **Lx51** linker/locator in the overlay analysis. Adjustments to the program call tree are typically required when your application uses function pointers or contains virtual program jumps as it is the case in the scheduler of a real-time operating system. The different forms of the overlay control are shown below:

| Control Specification | Description |
|--|--|
| OVERLAY (* ! <i>sfname</i>) | Add new root for <i>sfname</i> . |
| OVERLAY (<i>sfname</i> ! *) | Exclude <i>sfname</i> from the overlay analysis and locate data & bit segments in non-overlaid memory. This does not influence data overlaying of other functions. |
| OVERLAY (<i>sfname</i> ! <i>sfname1</i>) OVERLAY (<i>sfname</i> ! (<i>sfname1</i> , <i>sfname2</i>)) | Add <i>virtual</i> call references to segments or functions. |
| OVERLAY (<i>sfname</i> ~ <i>sfname1</i>) OVERLAY (<i>sfname</i> ~ (<i>sfname1</i> , <i>sfname2</i>)) | Ignore call references between segments or functions. |

sfname can be the name of a function or a segment.

Refer to “Using the Overlay Control” on page 282 for program examples that require the **OVERLAY** control.

Examples: If your application uses a real-time operating system, each task function might be an own program path or root and the call tree of that task must be independently analyzed. This is required since the task can be terminated (i.e. by a time-out) and a previously terminated task becomes running again. In the following example **Lx51** handles the functions **TASK0** and **TASK1** as independent programs or call trees:

Identify tasks of a real-time OS

```
BL51 SAMPLE.OBJ OVERLAY (* ! TASK0, TASK1)
```

NOTE

Task functions of the RTXx51 real-time operating system are automatically handled as in depended program roots. The OVERLAY control is not required for RTXx51 tasks.

Exclude a function from overlaying

In the next example, the local data and bit segments of **FUNC1** are excluded from data overlaying. This does not influence data overlaying of other functions.

```
BL51 SAMPLE.OBJ OVERLAY (FUNC1 ! *)
```

Add virtual function calls

You may add virtual references or functions calls for between segments or functions. In the following example, **Lx51** *thinks* during the overlay analysis that function **FUNC1** calls **FUNC2** and **FUNC3** even when no real calls exist.

```
BL51 CMODUL1.OBJ OVERLAY (FUNC1 ! (FUNC2, FUNC3))
```

Ignore references or function calls

You may delete or remove references between segments or functions. The next example **Lx51** ignores during overlay analysis the references to the **?PR?MAINMOD** segment from **FUNC1** and **FUNC2**:

```
BL51 MAINMOD.OBJ, TEXTOUT.OBJ &
OVERLAY (FUNC1 ~ ?PR?MAINMOD, FUNC2 ~ ?PR?MAINMOD)
```

9

RECURSIONS

Abbreviation: RC

Arguments: RECURSIONS (*number of recursions*)

Default: RECURSIONS (10)

µVision2 Control: Options – Lx51 Misc – Misc Controls: enter the control.

Description: The **RECURSIONS** control allows you to specify the *number of recursions* that are allowed before the **Lx51** linker/locator responds with:

```
FATAL ERROR 232: APPLICATION CONTAINS TOO MANY RECURSIONS.
```

Each time the linker encounters a recursive call during the overlay analysis of the application, this recursive call is automatically removed from the call tree and the overlay analysis is restarted. You might increase the number of accepted recursions on very complex recursive applications. However this might increase significantly the execution time of the Lx51 linker/locator.

If your application contains many pointer to function tables, you might receive the FATAL ERROR 232 before you have corrected the call tree with the OVERLAY control. The **RECURSIONS** control allows you in such situations to analysis the OVERLAY MAP of your application. Refer to “Pointer to a Function in Arrays or Tables” on page 286 for more information on correcting the call tree.

See Also: OVERLAY, SPEEDOVL

Example: LX51 MYPROG.OBJ,A.OBJ,B.OBJ RECURSIONS (100)

REGFILE

Abbreviation: RF

Arguments: REGFILE (*filename*)

Default: No register usage file is generated.

µVision2 Control: Options – Cx51 Compiler – Global Register Coloring.

Description: The **REGFILE** control allows you to specify the name of the register usage file generated by the **Lx51** linker/locator. The information in this file is used for global register optimization by the **Cx51** compiler. The register usage information allows the **Cx51** compiler to optimize the use of registers when calling external functions.

Example: In this example, the LX51 linker/locator generates the file **MYPROG.REG** that contains register usage information.

```
LX51 MYPROG.OBJ,A.OBJ,B.OBJ REGFILE(MYPROG.REG)
```

9

RTX251, RTX51, RTX51TINY**Abbreviation:** None**Arguments:** None**Default:** None**µVision2 Control:** Options – Target – Operating System.

Description: These controls specify to the **Lx51** linker/locator that the application should be linked for use with the **RTXx51** real-time multitasking operating system. This involves resolving references within your program to **RTXx51** functions found in the library of the real-time operating system.

The control that you should use, depends on the real-time operating system that you are using in your application:

| Control | Real-Time Operating System used |
|------------------|---------------------------------|
| RTX251 | RTX251 Full Multitasking RTOS. |
| RTX51 | RTX51 Full Multitasking RTOS. |
| RTX51TINY | RTX51 Tiny Multitasking RTOS. |

Examples: Linker/Locator invocation for RTX51 Full:

```
BL51 RTX_EX1.OBJ RTX51
```

Linker/Locator invocation for RTX251 Full:

```
L251 RTX_EX1.OBJ RTX251
```

SPEEDOVL

Restriction: This control is available in **BL51 only**. **LX51** and **L251** always ignore references from constant segments to program code during the overlay analysis.

Abbreviation: **SP**

Arguments: **None**

Default: **BL51** does not ignore the references from constant segments to program code during the overlay analysis.

µVision2 Control: Options – **BL51** Misc – Misc Controls: enter the control.

Description: The **RECURSIONS** control instructs **BL51** to ignore references from constant segments to program code during the overlay analysis. This improves the execution speed of the **BL51** linker/locater during overlay analysis and is useful for applications that are using “Pointer to a Function in Arrays or Tables” as described on page 286. However, the usage of the **SPEEDOVL** control makes the linker incompatible to existing applications that are using the **OVERLAY** control to correct the call tree of the application.

See Also: **OVERLAY, SPEEDOVL**

Example: `BL51 MYPROG.OBJ SPEEDOVL`

9

Error Messages

The **Lx51** linker/locator generates error messages that describe warnings, non-fatal errors, fatal errors, and exceptions.

Fatal errors immediately abort the **Lx51** linker/locator operation.

Errors and warnings do not abort the **Lx51** linker/locator operation; however, they may result in an output module that cannot be used. Errors and warnings generate messages that may or may not have been intended by the user. The listing file can be very useful in such an instance. Error and warning messages are displayed in the listing file as well as on the screen.

This section displays all the **Lx51** linker/locator error messages, causes, and any recovery actions.

Warnings

| Warning | Warning Message and Description |
|---------|---|
| 1 | <p>UNRESOLVED EXTERNAL SYMBOL SYMBOL: external-name MODULE: filename (modulename)</p> <p>The specified external symbol, requested in the specified module, has no corresponding PUBLIC symbol in any of the input files.</p> |
| 2 | <p>REFERENCE MADE TO UNRESOLVED EXTERNAL SYMBOL: external-name MODULE: filename (modulename) ADDRESS: code-address</p> <p>The specified unresolved external symbol is referenced at the specified code address.</p> |
| 3 | <p>ASSIGNED ADDRESS NOT COMPATIBLE WITH ALIGNMENT SEGMENT: segment-name</p> <p>The address specified for the segment is not compatible with the alignment of the segment declaration.</p> |
| 4 | <p>DATA SPACE MEMORY OVERLAP FROM: byte.bit address TO: byte.bit address</p> <p>The specified area of the on-chip data RAM is occupied by more than one segment.</p> |

| Warning | Warning Message and Description |
|---------|--|
| 5 | <p>CODE SPACE MEMORY OVERLAP FROM: byte address TO: byte address The specified area of the code memory is occupied by more than one segment.</p> |
| 6 | <p>XDATA SPACE MEMORY OVERLAP FROM: byte address TO: byte address The specified area of the external data memory is occupied by more than one segment.</p> |
| 7 | <p>MODULE NAME NOT UNIQUE MODULE: filename (modulename) The specified module name is used for more than one module. The specified module name is not processed.</p> |
| 8 | <p>MODULE NAME EXPLICITLY REQUESTED FROM ANOTHER FILE MODULE: filename (modulename) The specified module name is requested in the invocation line of another file that has not yet been processed. The specified module name is not processed.</p> |
| 9 | <p>EMPTY ABSOLUTE SEGMENT MODULE: filename (modulename) The specified module contains an empty absolute segment. This segment is not located and may be overlapped with another segment without any additional message.</p> |
| 10 | <p>CANNOT DETERMINE ROOT SEGMENT The Linker/Locator has recognized the C51 compiler or PL/M-51 input files and tries to process a flow analysis. However, it is impossible to determine the root segment. This error occurs if the main program is called by an assembly module. In this case, the available references (calls) must be modified with the OVERLAY control.</p> |
| 11 | <p>CANNOT FIND SEGMENT OR FUNCTION NAME NAME: overlay-control-name A segment or function name defined in the OVERLAY control cannot be found in the object modules.</p> |
| 12 | <p>NO REFERENCE BETWEEN SEGMENTS SEGMENT1: segment-name SEGMENT2: segment-name An attempt was made to delete a reference or call between two non-existent functions or segments, with the OVERLAY control.</p> |

| Warning | Warning Message and Description |
|---------|--|
| 13 | <p>RECURSIVE CALL TO SEGMENT SEGMENT: <code>segment-name</code> CALLER: <code>segment-name</code></p> <p>The specified segment is called recursively from CALLER specified segments. Recursive calls are not allowed in C51 and PL/M-51 programs.</p> |
| 14 | <p>INCOMPATIBLE MEMORY MODEL MODULE: <code>filename (modulename)</code> MODEL: <code>memory model</code></p> <p>The specified module is not compiled in the same memory model as the former compiled modules. The memory model of the improper module is showed by MODEL.</p> |
| 15 | <p>MULTIPLE CALL TO SEGMENT SEGMENT: <code>segment-name</code> CALLER1: <code>segment-name</code> CALLER2: <code>segment-name</code></p> <p>The specified segment is called from two levels, CALLER1, and CALLER2; e.g., main and interrupt program. This has the same effect as a recursive call and may thus lead to the overwriting of parameters or data.</p> |
| 16 | <p>UNCALLED SEGMENT, IGNORED FOR OVERLAY PROCESS SEGMENT: <code>segment-name</code></p> <p>This warning occurs when functions, which were not previously called, are contained in a program (e.g., for test purposes). The function specified is excluded from the overlay process in this case. It is possible that the program then occupies more memory as during a call of the specified segment.</p> |
| 17 | <p>INTERRUPT FUNCTION IN BANKS NOT ALLOWED SYMBOL: <code>function-name</code> SPACE: <code>code-bank</code></p> <p>The specified C function is an interrupt function (a C51 function) that was specified to be located in a code bank. Interrupt functions cannot be located in a code bank.</p> |
| 18 | no generated by Lx51 |
| 19 | <p>COMMON CODE SEGMENTS LOCATED TO BANKED AREA</p> <p>Some segments that are usually located to the common area located into the banked area. This warning just informs you, that you might free up some code space by locating program code into banks. The warning is not generated for the default setting of the BANKAREA (0 - 0xFFFF).</p> |
| 20 | <p>L51_BANK.A51: NBANKS < NUMBER OF CODE BANKS</p> <p>The setting for NBANKS in the L51_BANK.A51 module is smaller than the number of banks used in your application.</p> |

| Warning | Warning Message and Description |
|---------|---|
| 21 | <p>SEGMENT LOCATED OUTSIDE BANKED AREA</p> <p>A segment that should be located in the code banking area is located outside the address range of the BANKAREA directive.</p> |
| 22 | <p>SEGMENT SIZE UNDERFLOW: OLD SIZE + CHANGE < 0 SEGMENT: segment-name</p> <p>The size change specified in the SEGSIZE control causes the segment size to be less than zero.</p> |
| 23 | <p>UNRESOLVED EXTERNAL SYMBOL DURING LINK PROCESS</p> <p>During the link run one or more external symbols have no corresponding PUBLIC symbol in any of the input files.</p> |
| 24 | <p>INCOMPATIBLE CPU MODE MODULE: module-name MODE: cpu-mode</p> <p>The specified module is not translated with the same CPU mode as the former Lx51 input modules. The CPU mode of the invalid module is displayed by MODE. The CPU mode of other input modules is displayed in the Lx51 listing file.</p> |
| 25 | <p>DATA TYPES DIFFERENT SYMBOL: symbol-name MODULE: module-name</p> <p>The definition of the specified symbol in the specified module is not identical with the public definition of that symbol. The module which contains the public symbol can be determined with the IXREF listing. This warning is disabled with WARNINGLEVEL (0) control.</p> |
| 26 | <p>DATA TYPES SLIGHTLY DIFFERENT SYMBOL: symbol-name MODULE: module-name</p> <p>The definition of the specified symbol in the specified module is not 100% identical with the public definition of that symbol. This warning is the result when unsigned signed mismatches occur, i.e. unsigned char does not match char. The module which contains the public symbol can be determined with the IXREF listing. This warning is disabled with WARNINGLEVEL (1) control.</p> |
| 27 | <p>INCOMPATIBLE INTERRUPT FRAME SIZE MODULE: module-name FRAME: frame-size</p> <p>The specified module is not translated with the same interrupt frame size assumptions as the former input modules. The frame size of the invalid module is displayed by FRAME. The frame size of other input modules is displayed in the Lx51 listing file.</p> |

9

| Warning | Warning Message and Description |
|---------|---|
| 28 | DECREASING SIZE OF SEGMENT SEGMENT: segment-name The size specified in the SEGSIZE control has caused Lx51 to decrease the size of the specified segment. |
| 29 | SEGMENT LOCATED OUTSIDE CLASS AREA SEGMENT: segment-name The specified segment is located outside the memory class limits specified by the CLASSES control. |
| 30 | MEMORY SPACE OVERLAP FROM: address TO: address The specified area of the physical memory is occupied by more than one segment. |

Non-Fatal Errors

9

| Error | Error Message and Description |
|-------|--|
| 101 | <p>SEGMENT COMBINATION ERROR SEGMENT: <code>segment-name</code> MODULE: <code>filename (modulename)</code></p> <p>The attributes of the specified partial segment in the specified module cannot be combined with the attributes of the previous defined partial segments of the same name. The partial segment is ignored.</p> |
| 102 | <p>EXTERNAL ATTRIBUTE MISMATCH SYMBOL: <code>external-name</code> MODULE: <code>filename (modulename)</code></p> <p>The attributes of the specified external symbol in the specified module do not match the attributes of the previously defined external symbols. The specified symbol is ignored.</p> |
| 103 | <p>EXTERNAL ATTRIBUTE DO NOT MATCH PUBLIC SYMBOL: <code>public-name</code> MODULE: <code>filename (modulename)</code></p> <p>The attributes of the specified public symbols in the specified module do not match the attributes of the previous defined external symbols. The specified symbol is ignored.</p> |
| 104 | <p>MULTIPLE PUBLIC DEFINITIONS SYMBOL: <code>public-name</code> MODULE: <code>filename (modulename)</code></p> <p>The specified public symbol in the specified module has already been defined in a previously processed file.</p> |
| 105 | <p>PUBLIC REFERS TO IGNORED SEGMENT SYMBOL: <code>public-name</code> SEGMENT: <code>segment-name</code></p> <p>The specified public symbol is defined in the specified segment. It cannot be processed on account of an error. The public symbol is therefore ignored.</p> |
| 106 | <p>SEGMENT OVERFLOW SEGMENT: <code>segment-name</code></p> <p>The specified segment is longer than the limits implied by the memory class to which the segment belongs to.</p> |
| 107 | <p>ADDRESS SPACE OVERFLOW SPACE: <code>space-name</code> SEGMENT: <code>segment-name</code></p> <p>The specified segment cannot be located at the specified address space. The segment is ignored.</p> |

| Error | Error Message and Description |
|-------|---|
| 108 | <p>SEGMENT IN LOCATING CONTROL CANNOT BE ALLOCATED SEGMENT: segment-name The specified segment in the invocation line cannot be processed on account of its attributes.</p> |
| 109 | <p>EMPTY RELOCATABLE SEGMENT SEGMENT: segment-name The specified segment after combination has a zero size. The specified segment is ignored.</p> |
| 110 | <p>CANNOT FIND SEGMENT SEGMENT: segment-name The specified segment is contained in the invocation line but cannot be found in an input module. The specified segment is ignored.</p> |
| 111 | <p>SPECIFIED BIT ADDRESS NOT ON BYTE BOUNDARY SEGMENT: segment-name The specified segment contained in the BIT control is a DATA segment. The specified BIT address however is not on a byte boundary. The segment is ignored.</p> |
| 112 | <p>SEGMENT TYPE NOT LEGAL FOR COMMAND SEGMENT: segment-name The specified segment cannot be processed because it does not have a legal type.</p> |
| 113 | <p>SEGMENT IN LOCATING CONTROL IS ALREADY ABSOLUTE SEGMENT: segment-name The specified segment is already an absolute segment and cannot be located with the SEGMENTS control.</p> |
| 114 | <p>SEGMENT DOES NOT FIT SPACE: space-name SEGMENT: segment-name BASE: base-address LENGTH: segment-length The specified segment cannot be located at the base address in the specified address space because of its length. The segment is ignored.</p> |
| 115 | <p>INPAGE SEGMENT IS GREATER THAN 256 BYTES SEGMENT: segment-name The specified segment with the attributes PAGE or INPAGE is greater than 256 bytes. The segment is ignored.</p> |

| Error | Error Message and Description |
|-------|--|
| 116 | <p>INBLOCK SEGMENT IS GREATER THAN 2048 BYTES SEGMENT: segment-name The specified segment with the attribute INBLOCK is greater than 2048 bytes. The segment is ignored.</p> |
| 117 | <p>BIT ADDRESSABLE SEGMENT IS GREATER THAN 16 BYTES SEGMENT: segment-name The specified bit or data segment that was declared with the BITADDRESSABLE attribute is larger than 16 bytes. The segment is not ignored.</p> |
| 118 | <p>REFERENCE MADE TO ERRONEOUS EXTERNAL SYMBOL: symbol-name MODULE: filename (modulename) ADDRESS: code-address The specified external symbol that was erroneously processed, is referenced in the specified code address.</p> |
| 119 | <p>REFERENCE MADE TO ERRONEOUS SEGMENT SEGMENT: symbol-name MODULE: filename (modulename) ADDRESS: code-address The specified segment processed with an error, is referenced in the specified code address.</p> |
| 120 | <p>CONTENT BELONGS TO ERRONEOUS SEGMENT SEGMENT: segment-name MODULE: filename (modulename) A specified segment that was erroneously processed, is referenced at a specific code address. The segment contents are not available.</p> |
| 121 | <p>IMPROPER FIXUP MODULE: filename (modulename) SEGMENT: segment-name OFFSET: segment-address After evaluation of absolute fix-ups, an address is not accessible. The improper address along with the specific module name, partial segment, and segment address are displayed. The fix-up command is not processed.</p> <p>This error occurs when an instruction cannot reach the address, i.e. ACALL instruction calls a location outside the 2KB block. If you are working with the Cx51 compiler, you have typically selected the ROM(SMALL) option for a program that exceeds the 2KB ROM size. You can locate the instruction, when you open the LST file of the translator and search for the instruction that is located in the offset of the specified segment.</p> |
| 122 | <p>CANNOT FIND MODULE MODULE: filename (modulename) The module specified in the invocation line cannot be found in the input file.</p> |

| Error | Error Message and Description |
|-------|---|
| 123 | <p>ABSOLUTE DATA/IDATA SEGMENT DOES NOT FIT MODULE: filename (modulename) FROM: byte address TO: byte address</p> <p>An absolute DATA or IDATA segment contained in the specified module is not permissible due to a conflict with the value specified with the RAMSIZE control. The absolute segment cannot be located in the area, which was output.</p> |
| 124 | <p>BANK SWITCH MODULE INCORRECT</p> <p>This error message is issued when the bank switch module file (L51_BANK.OBJ) contains invalid information or is not specified.</p> |
| 125 | <p>DUPLICATE TASK NUMBER TASK1: function name TASK2: function name TASKID: task-id</p> <p>A task number has been assigned to more than one RTXx51 task function.</p> |
| 126 | <p>TASK WITH PRIORITY 3 CANNOT WORK WITH REGISTERBANK 0 TASK: function name TASKID: task-id</p> <p>A task that has priority 3 must have a using attribute that refers to register bank 1, 2, or 3.</p> |
| 127 | <p>UNRESOLVED EXTERNAL SYMBOL SYMBOL: external-name MODULE: filename (modulename)</p> <p>The specified external symbol, requested in the specified module, has no corresponding PUBLIC symbol in any of the input files.</p> |
| 128 | <p>REFERENCE MADE TO UNRESOLVED EXTERNAL SYMBOL: external-name MODULE: filename (modulename) ADDRESS: code-address</p> <p>The specified unresolved external symbol is referenced at the specified code address.</p> |
| 129 | <p>TASK REQUIRES REGISTERBANK TASK: function name TASKID: task-id</p> <p>The task function requires that you assign a register bank with an using attribute.</p> |
| 130 | <p>NO MATCHING SEGMENT FOR WILDCARD SEGMENT NAME SEGMENT: segment-name</p> <p>The linker could not find a segment name that matches the wildcard segment name stated in the command line.</p> |

| Error | Error Message and Description |
|-------|---|
| 131 | ILLEGAL PRIORITY FOR TASK TASK: function name TASKID: task-id You have assigned a priority for an RTX51 Tiny task. RTX51 Tiny does not support priorities. |
| 132 | ILLEGAL TASKID: RTX-51 TINY SUPPORTS ONLY 16 TASKS TASK: function name TASKID: task-id You have assigned a task-id that is higher than 15. RTX51 Tiny tasks supports only 16 tasks. |
| 133 | SFR SYMBOL HAS DIFFERENT VALUES SYMBOL: public-name MODULE: filename (modulename) The specified SFR symbol is defined with different values in several input modules. |
| 134 | ADDRESS SPACE OVERFLOW IN BANKAREA SPACE: space-name SEGMENT: segment-name The specified segment cannot be located in the banked area, since the banked area is already full. |

9

Fatal Errors

| Error | Error Message and Description |
|-------|---|
| 201 | INVALID COMMAND LINE SYNTAX A syntax error is detected in the command line. The command line is displayed up to and including the point of error. |
| 202 | INVALID COMMAND LINE, TOKEN TOO LONG The command line contains a token that is too long. The command line is displayed up to and including the point of error. |
| 203 | EXPECTED ITEM MISSING An expected item is missing in the command line. The command line is displayed up to and including the point of error. |
| 204 | INVALID KEYWORD The invocation line contains an invalid keyword. The command line is displayed up to and including the point of error. |
| 205 | CONSTANT TOO LARGE A constant in the invocation line is larger than 0FFFFH. The command line is displayed up to and including the point of error. |
| 206 | INVALID CONSTANT A constant in the invocation line is invalid; e.g., a hexadecimal number with a leading letter. The command line is displayed up to and including the point of error. |
| 207 | INVALID NAME A module or segment name is invalid. The command line is displayed up to and including the point of error. |
| 208 | INVALID FILENAME A filename is invalid. The command line is displayed up to and including the point of error. |
| 209 | FILE USED IN CONFLICTING CONTEXTS FILE: filename A specified filename is used for multiple files or used as an input as well as an output file. |
| 210 | I/O ERROR ON INPUT FILE: system error message FILE: filename An I/O error is detected by accessing an input file. A detailed error description of the EXCEPTION messages is described afterwards. |

| Error | Error Message and Description |
|-------|---|
| 211 | <p>I/O ERROR ON OUTPUT FILE: system error message FILE: filename</p> <p>An I/O error is detected by accessing an output file. A detailed error description of the EXCEPTION messages is described afterwards.</p> |
| 212 | <p>I/O ERROR ON LISTING FILE: system error message FILE: filename</p> <p>An I/O error is detected by accessing a listing file. A detailed error description of the EXCEPTION messages is described afterwards.</p> |
| 213 | <p>I/O ERROR ON WORK FILE: system error message</p> <p>An I/O error is detected by accessing a temporary work file of BL51. A detailed error description of the EXCEPTION messages is described afterwards.</p> |
| 214 | <p>INPUT PHASE ERROR MODULE: filename (modulename)</p> <p>This error occurs when BL51 encounters different data during pass two. This error could be the result of an assembly error.</p> |
| 215 | <p>CHECK SUM ERROR MODULE: filename (modulename)</p> <p>The checksum does not correspond to the contents of the file.</p> |
| 216 | <p>INSUFFICIENT MEMORY</p> <p>The memory available for the execution of BL51 is used up.</p> |
| 217 | <p>NO MODULE TO BE PROCESSED</p> <p>No module to be processed is found in the invocation line.</p> |
| 218 | <p>NOT AN OBJECT FILE FILE: filename</p> <p>The specified file is not an object file.</p> |
| 219 | <p>NOT AN 8051/X51 OBJECT FILE FILE: filename</p> <p>The specified file is not a valid x51 object file.</p> |
| 220 | <p>INVALID INPUT MODULE FILE: filename</p> <p>The specified input module is invalid. This error could be the result of an assembler error.</p> |

| Error | Error Message and Description |
|-------|--|
| 221 | <p>MODULE SPECIFIED MORE THAN ONCE The invocation line contains the specified module more than once. The command line is displayed up to and including the point of error.</p> |
| 222 | <p>SEGMENT SPECIFIED MORE THAN ONCE The invocation line contains the specified segment more than once. The command line is displayed up to and including the point of error.</p> |
| 224 | <p>DUPLICATE KEYWORD OR CONFLICTING CONTROL The same keyword is contained in the invocation line more than once or contradicts with other keywords. The command line is displayed up to and including the point of error.</p> |
| 225 | <p>SEGMENT ADDRESS ARE NOT IN ASCENDING ORDER The base addresses for the segments are not displayed in ascending order during the location control. The command line is displayed up to and including the point of error.</p> |
| 226 | <p>SEGMENT ADDRESS INVALID FOR CONTROL The base addresses for the segments are invalid for the location control. The command line is displayed up to and including the point of error.</p> |
| 227 | <p>PARAMETER OUT OF RANGE The specified value for the PAGEWIDTH or PAGELENGTH control is out of the acceptable range. The command line is displayed up to and including the point of error.</p> |
| 228 | <p>RAMSIZE PARAMETER OUT OF RANGE The specified value for the RAMSIZE control is out of the acceptable range. The command line is displayed up to and including the point of error.</p> |
| 229 | <p>INTERNAL PROCESS ERROR Lx51 detects an internal processing error. Please contact your dealer.</p> |
| 230 | <p>START ADDRESS SPECIFIED MORE THAN ONCE The invocation line contains more than one start address for unnamed segment group. The command is displayed up to and including the point of error.</p> |
| 231 | <p>ADDRESS RANGE FOR BANKAREA INCORRECT The address space specified with the BANKAREA control is invalid.</p> |
| 232 | <p>APPLICATION CONTAINS TOO MANY RECURSIONS The application contains too many recursive calls. Refer to "RECURSIONS" on page 356 for more information.</p> |

| Error | Error Message and Description |
|-------|--|
| 233 | ILLEGAL USE OF * IN OVERLAY CONTROL The use of “* ! *” or “* ~ *” with the OVERLAY control is illegal. |
| 234 | USE RTX251 OR RTX51 CONTROL The application uses RTXx51 tasks. |
| 233 | ILLEGAL USE OF * IN OVERLAY CONTROL command line The use of “* ! *” or “* ~ *” with the OVERLAY control is illegal. |
| 234 | USE RTX-251 SWITCH The application uses a real-time operating system RTX251 Full or RTX251 Tiny. The L251 linker/locater must be invoked with the RTX251 or RTX251TINY control. |
| 235 | TOO MANY ADDRESS RANGES You are using too many address ranges. |
| 236 | ADDRESSES ARE NOT IN ASCENDING ORDER The address range does not contain addresses in ascending order. |
| 237 | INVALID CLASS NAME The class name given in the CLASSES control is not valid. |
| 238 | BIT ADDRESS INVALID FOR THIS CLASS TYPE The CLASSES control contains a bit address for a memory class which cannot be used for bit objects. |
| 239 | BASE ADDRESS ALREADY GIVEN FOR THIS CLASS The CLASSES control contains a base address, but the class has already a base address specified with a previous CLASSES control. |
| 240 | BASE ADDRESS MUST BE THE FIRST ARGUMENT The base address must be the first argument in the CLASSES control. |
| 241 | BASE ADDRESS CANNOT BE GIVEN FOR THIS CLASS A base address cannot be given for this memory class in the CLASSES control. |
| 242 | WRONG SYNTAX FOR THE EXECUTION ADDRESS The execution address field contains a wrong syntax. |
| 243 | EXECUTION ADDRESS REQUIRED IF SPACE IS NOT RESERVED You need to specify an execution address, if the execution space should not be reserved. |

9

| Error | Error Message and Description |
|-------|---|
| 244 | OVERLAPPING CLASS RANGE The address ranges in the classes control are overlapping. |
| 245 | ADDRESS RANGE INVALID FOR THIS CLASS TYPE The address range given in the CLASSES control is not valid for this memory class type. |
| 246 | SYMBOL SPECIFIED MORE THAN ONCE The symbol name is already used. |
| 249 | MODULE USES AN UNKNOWN OMF VERSION MODULE: filename (modulename) The module uses an un-known or unsupported OMF version. |
| 250 | CODE SIZE LIMIT IN RESTRICTED VERSION EXCEEDED You are using modules that are created with an evaluation version or a code size limited version and the size limit is exceeded. |
| 251 | RESTRICTED MODULE IN LIBRARY NOT SUPPORTED A library contains a module that is created with an evaluation version or a code size limited version. This is not supported. |

Exceptions

Exception messages are displayed with some error messages. The **BL51** linker/locator exception messages that are possible are listed below:

| Exception | Exception Message and Description |
|-----------|---|
| 0021H | PATH OR FILE NOT FOUND The specified path or filename is missing. |
| 0026H | ILLEGAL FILE ACCESS An attempt was made to write to or delete a write-protected file. |
| 0029H | ACCESS TO FILE DENIED The file indicated is a directory. |
| 002AH | I/O-ERROR The drive being written to is either full or the drive was not ready. |
| 0101H | ILLEGAL CONTEXT An attempt was made to access a file in an illegal context; e.g., the printer was opened for reading. |

9

Chapter 10. Library Manager

The **LIBx51** library manager allows you to create and maintain library files. A library file is a formatted collection of one or more object files. Library files provide a convenient method of referencing a large number of object files and can be used by the **Lx51** linker/locator. The **LIBx51** library manager can be controlled interactively or from the command line.

The following table gives you an overview of the **LIBx51** library manager variants along with the translators that are supported.

| Library Manager | Processes Files from... | Description |
|-----------------|--|---|
| LIB51 | Keil A51 Macro Assembler Keil C51 Compiler Intel ASM51 Assembler Intel PL/M51 Compiler | For classic 8051 . Includes support for 32 x 64KB code banks. |
| LIBX51 | Keil A51 Macro Assembler Keil C51 Compiler Keil AX51 Macro Assembler Keil CX51 Compiler for 80C51MX Intel ASM51 Assembler Intel PL/M51 Compiler | For classic 8051 and extended 8051 versions (Philips 80C51MX , Dallas 390 , etc.) Allows code and data banking and supports up to 16MB code and xdata memory. |
| LIB251 | Keil A51 Macro Assembler Keil C51 Compiler Keil A251 Macro Assembler Keil C251 Compiler Intel ASM51 Assembler Intel PL/M51 Compiler | For Intel/Atmel WM 251 . |

Using LIBx51

To invoke the **LIBx51** library manager from the command prompt, type the program name along with an optional command. The format for the **LIBx51** command line is:

```
LIB51 [command]
LIBX51 [command]
LIB251 [command]
```

or

```
LIB51 @commandfile
LIBX51 @commandfile
LIB251 @commandfile
```

where

command may be a single library manager command.

commandfile is the name of a command input file that may contain a very long library manager *command*.

Interactive Mode

If no *command* is entered on the command line, or if the ampersand character is included at the end of the line, the LIB51 library manager enters interactive mode. The **LIBx51** library manager displays an asterisk character (*) to signal that it is in interactive mode and is waiting for input.

Any of the **LIBx51** library manager commands may be entered on the command line or after the * prompt when in interactive mode.

Type **EXIT** to leave the **LIBx51** library manager interactive mode.

Create Library within μ Vision2

You can directly create a library file from your μ Vision2 project. Select **Create Library** in the dialog **Options for Target – Output**. μ Vision2 will call the correct **LIBx51** Library Manager instead of the **Lx51** Linker/Locator. Since the

code in the Library will be not linked and located, the entries in the **L51 Locate** and **L51 Misc** options page are ignored.

Command Summary

The following table lists the commands that are available for the **LIBx51** library manager. The usage and the syntax of these commands are described in the sections that follow.

10

NOTE

Underlined characters denote the abbreviation for the particular command.

| LIBx51 Command | Description |
|------------------------|---|
| <u>A</u>DD | Adds an object module to the library file. For example, <code>LIB51 ADD GOODCODE.OBJ TO MYLIB.LIB</code> adds the GOODCODE.OBJ object module to MYLIB.LIB . |
| <u>C</u>REATE | Creates a new library file. For example, <code>LIB251 CREATE MYLIB.LIB</code> creates a new library file named MYLIB.LIB . |
| <u>D</u>ELETE | Removes an object module from the library file. For example, <code>LIBX51 DELETE MYLIB.LIB (GOODCODE)</code> removes the GOODCODE module from MYLIB.LIB . |
| <u>E</u>XTRACT | Extracts an object module from the library file. For example, <code>LIB251 EXTRACT MYLIB.LIB (GOODCODE) TO GOOD.OBJ</code> copies the GOODCODE module to the object file GOOD.OBJ . |
| <u>E</u>XIT | Exits the library manager interactive mode. |
| <u>H</u>ELP | Displays help information for the library manager. |
| <u>L</u>IST | Lists the module and public symbol information stored in the library file. For example, <code>LIB251 LIST MYLIB.LIB TO MYLIB.LST PUBLICS</code> generates a listing file (named MYLIB.LST) that contains the module names stored in the MYLIB.LIB library file. The PUBLICS directive specifies that public symbols are also included in the listing. |
| <u>R</u>EPLACE | Replaces an existing object module to the library file. For example, <code>LIB51 REPLACE GOODCODE.OBJ IN MYLIB.LIB</code> replaces the GOODCODE.OBJ object module in MYLIB.LIB . Note that Replace will add GOODCODE.OBJ to the library if it does not exist. |
| <u>T</u>RANSFER | Generates a complete new library and adds object modules. For example, <code>LIB251 TRANSFER FILE1.OBJ, FILE2.OBJ TO MYLIB.LIB</code> deletes the existing library MYLIB.LIB , re-creates it and adds the object modules FILE1.OBJ and FILE2.OBJ to that library. |

Creating a Library

The **CREATE** command creates a new, empty library file and has the following format:

```
CREATE libfile
```

libfile is the name of the library file to create and should include a file extension. Usually, **.LIB** is the extension that is used for library files.

Example:

```
LIBX51 CREATE MYFILE.LIB
* CREATE FASTMATH.LIB
```

The **TRANSFER** command creates a new library file and adds object modules. The **TRANSFER** command must be entered in the following format:

```
TRANSFER filename [(modulename, ...)] [, ...] TO libfile
```

where

filename is the name of an object file or library file. You may specify several files separated by a comma.

modulename is the name of a module in a library file. If you do not want to add the entire contents of a library, you may select the modules that you want to add. Module names are specified immediately following the *filename*, must be enclosed in parentheses, and must be separated by commas.

libfile is the name of the library file that should be created. The **LIBx51** library manager will remove a previous version of the library, if this file already exists. The specified object modules are added to the new created library.

Example:

```
LIB251 TRANSFER FILE1.OBJ, FILE2.OBJ TO MYLIB.LIB
LIBX51 @mycmd.lin
--- content of mycmd.lin: ---
TRANSFER FILE1.OBJ, FILE2.OBJ, FILE3.OBJ TO MYLIB.LIB
```

Adding or Replacing Object Modules

The **ADD** command is used to add one or more object modules to an existing library file. The **ADD** command must be entered in the following format:

```
ADD filename [(modulename, ...)] [, ...] TO libfile
```

where

filename is the name of an object file or library file. You may specify several files separated by a comma.

modulename is the name of a module in a library file. If you do not want to add the entire contents of a library, you may select the modules that you want to add. Module names are specified immediately following the *filename*, must be enclosed in parentheses, and must be separated by commas.

libfile is the name of an existing library file. The specified object modules are added to this library.

Example:

```
LIB51 ADD MOD1.OBJ, UTIL.LIB(FPMUL, FPDIV) TO NEW.LIB
* ADD FPMOD.OBJ TO NEW.LIB
```

With the **REPLACE** command you can update an existing object module in a library file. The **REPLACE** command will the object module to the library if it does not exist. The format is:

```
REPLACE filename IN libfile
```

where

filename is the name of an object file you want to update.

libfile is the name of an existing library file. The object module is replaced in this library.

Example:

```
LIBX51 REPLACE MOD1.OBJ IN MYLIB.LIB
* REPLACE FPMOD.OBJ TO FLOAT.LIB
```

Removing Object Modules

The **DELETE** command removes object modules from a library file. This command must be entered in the following format:

```
DELETE libfile (modulename [, modulename ...])
```

where

libfile is the name of an existing library file. The specified object modules are removed from this library.

modulename is the name of a module in the library file that you want to remove. Module names are entered in parentheses and are separated by commas.

Example:

```
LIB51 DELETE NEW.LIB (MODUL1)
* DELETE NEW.LIB (FPMULT, FPDIV)
```

Extracting Object Modules

The **EXTRACT** command creates a standard object module for a specified module in a library file. This command must be entered in the following format:

```
EXTRACT libfile (modulename) TO filename
```

where

libfile is the name of an existing library file. For the specified object module a standard object module will be created.

modulename is the name of a module in the library file. Only one module name can be entered in parentheses.

filename is the name of the object file that should be created from the library module.

Example:

```
LIBX51 EXTRACT FLOAT.LIB (FPMUL) TO FLOATMUL.OBJ
```

Listing Library Contents

Use the **LIST** command to direct the **LIBx51** library manager to generate a listing of the object modules that are stored in a library file. **LIST** may be specified on the command line or after the * prompt in interactive mode. This command has the following format:

```
LIST libfile [TO listfile] [PUBLICS]
```

where

libfile is the library file from which a module list is generated.

listfile is the file where listing information is written. If no *listfile* is specified, the listing information is displayed on the screen.

PUBLICS specifies that public symbols are included in the listing. Normally, only module names are listed.

Example:

```
LIB251 LIST NEW.LIB
* LIST NEW.LIB TO NEW.LST PUBLICS
```

The **LIBx51** library manager produces a module listing that appears as follows:

```
LIBRARY: NEW.LIB
  PUTCHAR
    _PUTCHAR
  PRINTF
    ? _PRINTF517?BYTE
    ? _SPRINTF517?BYTE
    ? _PRINTF?BYTE
    ? _SPRINTF?BYTE
    _PRINTF
    _SPRINTF
    _PRINTF517
    _SPRINTF517
  PUTS
    _PUTS
```

In this example, **PUTCHAR**, **PRINTF**, and **PUTS** are module names. The names listed below each of these module names are public symbols found in each of the modules.

Error Messages

This chapter lists the fatal and non-fatal errors that may be generated by the LIB51 library manager during execution. Each section includes a brief description of the message, as well as corrective actions you can take to eliminate the error or warning condition.

10

Fatal Errors

Fatal errors cause immediate termination of the LIB51 library manager. These errors normally occur as the result of a corrupt library or object file, or as a result of a specification problem involving library or object files.

| Error | Error Message and Description |
|-------|--|
| 215 | CHECK SUM ERROR FILE: <i>filename</i> The checksum for filename is incorrect. This usually indicates a corrupt file. |
| 216 | INSUFFICIENT MEMORY There is not enough memory for the LIB51 library manager to successfully complete the requested operation. |
| 217 | NOT A LIBRARY FILE: <i>filename</i> The filename that was specified is not a library file. |
| 219 | NOT AN 8051 OBJECT FILE FILE: <i>filename</i> The filename that was specified is not a valid 8051 object file. |
| 222 | MODULE SPECIFIED MORE THAN ONCE MODULE: <i>filename</i> (<i>modulename</i>) The specified modulename is included on the command line more than once. |

Errors

The following errors cause immediate termination of the LIB51 library manager. These errors usually involve invalid command line syntax or I/O errors.

| Error | Error Message and Description |
|-------|--|
| 201 | INVALID COMMAND LINE SYNTAX A syntax error was detected in the command. The command line is displayed up to and including the point of error. |
| 202 | INVALID COMMAND LINE, TOKEN TOO LONG The command line contains a token that is too long for the LIB51 library manager to process. |
| 203 | EXPECTED ITEM MISSING The command line is incomplete. An expected item is missing. |
| 205 | FILE ALREADY EXISTS FILE: filename The filename that was specified already exists. This error is usually generated when attempting to create a library file that already exists. Erase the file or use a different filename. |
| 208 | MISSING OR INVALID FILENAME A filename is missing or invalid. |
| 209 | UNRECOGNIZED COMMAND A command is unrecognized by the LIB51 library manager. Make sure you correctly specified the command name. |
| 210 | I/O ERROR ON INPUT FILE: system error message FILE: filename An I/O error was detected when accessing one of the input files. |
| 211 | I/O ERROR ON LIBRARY FILE: system error message FILE: filename An I/O error was detected when accessing a library file. |
| 212 | I/O ERROR ON LISTING FILE: system error message FILE: filename An I/O error was detected when accessing a listing file. |

| Error | Error Message and Description |
|-------|---|
| 213 | I/O ERROR ON TEMPORARY FILE: system error message FILE: filename An I/O error was detected when a temporary file was being accessed. |
| 220 | INVALID INPUT MODULE FILE: filename The specified input module is invalid. This error could be the result of an assembler error or could indicate that the input object file is corrupt. |
| 221 | FILE SPECIFIED MORE THAN ONCE FILE: filename The filename specified was included on the command line more than once. |
| 223 | CANNOT FIND MODULE MODULE: filename (modulename) The modulename specified on the command line was not located in the object or library file. |
| 224 | ATTEMPT TO ADD DUPLICATE MODULE MODULE: filename (modulename) The specified modulename already exists in the library file and cannot be added. |
| 225 | ATTEMPT TO ADD DUPLICATE PUBLIC SYMBOL MODULE: filename (modulename) PUBLIC: symbolname The specified public symbolname in modulename already exists in the library file and cannot be added. |

Chapter 11. Object-Hex Converter

Program code stored in an absolute object file can be converted an Intel HEX file. Intel HEX files may be used as input files for EPROM programmers or emulators.

For the each **Lx51** linker/locator variant a different **OHx51** object hex converter is required to create an Intel HEX file. For code banking applications generated with the **BL51** linker/locator, you need in addition the **OC51** Banked Object File Converter to create HEX files. The following table gives you an overview of the conversion tools required to create an Intel HEX file.

| Output from... | Object Hex Converter | Description |
|--------------------------------|--------------------------------|--|
| BL51 | OH51 | For classic 8051 applications without banking. |
| BL51 Banked Application | OC51 combined with OH51 | For classic 8051 applications with banking. |
| LX51 | OHX51 | For classic 8051 and extended 8051 versions. |
| L251 | OH251 | For Intel/Atmel WM 251 . |

In μ Vision2 you enable the generation of an Intel Object file in the dialog **Options – Output** with **Create HEX File**. The μ Vision2 project manager selects automatically the correct utility.

The following sections describe how to use the **OHx51** and **OC51** utilities, the command-line options that are available, and any errors that may be encountered during execution.

Using OHx51

To invoke **OHx51** from the command prompt, type the program name along with the name of the absolute object file. The command line format for the **OHx51** utilities is:

```
OH51 abs_file [HEXFILE (file)]
OHX51 abs_file [HEXFILE (file)] [H386] [RANGE (start-end)] [OFFSET (offset)]
OH251 abs_file [HEXFILE (file)] [H386] [RANGE (start-end)] [OFFSET (offset)]
```

where

abs_file is the name of the absolute object file that is generated by the **Lx51** linker/locator.

file is the name of the Intel HEX file to generate. By default, the HEX file name is the name of the ***abs_file*** with the extension **.HEX**.

H386 specifies Intel HEX-386 format for the Intel HEX file. This format is automatically used, if the specified address range is more than 64KBytes.

start-end specifies the address range of the ***abs_file*** that should be converted to the Intel HEX file. The default range depends on the device you are using and is listed in the following table:

| OHx51 Converter (Architecture) | Address Range |
|---|---------------------|
| OHX51 (Classic, and Extended 8051) Note: For code banking applications OHX51 the default setting converts the complete content into an Intel HEX-386 format. | C:0x0000 - C:0xFFFF |
| OHX51 (Philips 80C51MX) | 0x800000 - 0x80FFFF |
| OH251 (Intel/Atmel WM 251) | 0xFF0000 - 0xFFFFF |

offset specifies an ***offset*** which is added to the address stored in the ***abs_file***.

OHx51 Command Line Examples

The following command generates an Intel HEX-386 file for a 251 device. The address range 0xFE0000 - 0xFFFFFFFF should be converted. The offset 0xFE0000 is subtracted to get an Intel HEX file that can be directly programmed into an EPROM that is mapped to the address space 0xFE0000 - 0xFFFFFFFF in the 251 address space.

```
OH251 MYPROG RANGE (0xFE0000-0xFFFFFFFF) OFFSET (-0xFE0000)
```

The next example generates an Intel HEX file for a banked application with a classic 8051 device. Only the code bank 0 should be converted. The file format used will be the standard Intel HEX format.

```
OHX51 PROG RANGE (B:0-B:0xFFFF)
```

The command below generates an Intel HEX-386 file for a Philips 80C51MX device. The **OFFSET** control is used to create an output file that can be directly programmed into an EPROM.

```
OHX51 MYAPP RANGE (0x800000-0x81FFFF) OFFSET (-0x800000)
```

With the next command line, the constants stored in the XDATA space are converted into an Intel HEX file.

```
OHX51 MYPROG RANGE (X:0-X:FFFF)
```

Creating HEX Files for Banked Applications

For the **BL51** linker/locater the **OC51** Banked Object File Converter described on page 392 is used to split banked object files into standard object files that contain a 64KB code bank. These files can be converted with **OH51** into HEX files that store the content of a 64KB bank. These files are programmed separately into the corresponding physical address space of the EPROM.

For the extended **LX51** linker/locater the **OHX51** object hex converter generates in the default setting and Intel HEX-386 file that contains the common area and all the code banks. If code bank 0 does not exist in your application, **OHX51** will skip this memory area.

Examples:

The figure below shows the HEX

The following figure shows the

file content for the example
**“Banking With Four 64 KByte
 Banks”** on page 299.

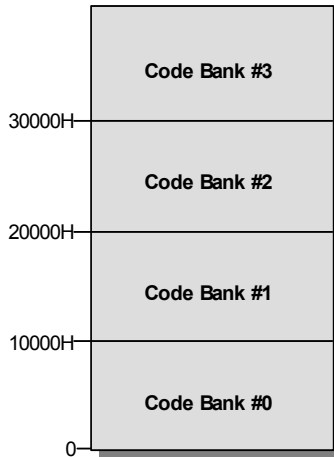

HEX file content for the example
“Banking With Common Area”
 on page 303.

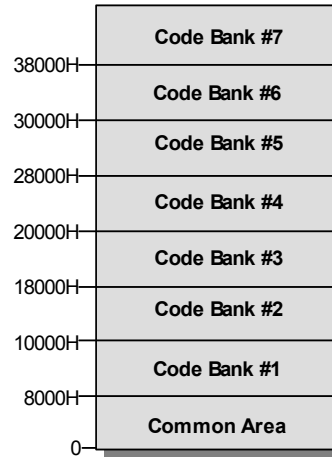

OHx51 Error Messages

The following tables list error and warning messages of **OHx51**. Each message includes a brief description of the reason for the error or warning condition.

| Error Message |
|---|
| <p>*** ERROR, INVALID RECORD-TYPE ENCOUNTERED The absolute object file contains an invalid record type.</p> |
| <p>*** FATAL, INCONSISTENT OBJECT FILE The input file has an invalid format.</p> |
| <p>*** ERROR, ARGUMENT TOO LONG An argument in the command line is too long.</p> |
| <p>*** ERROR, DELIMITER '(' AFTER PARAMETER EXPECTED The command-line parameter must be followed by an argument enclosed in parentheses ().</p> |
| <p>*** ERROR, DELIMITER ')' AFTER PARAMETER EXPECTED The command-line parameter must be followed by an argument enclosed in parentheses ().</p> |
| <p>*** ERROR, UNKNOWN CONTROL: The specified command-line parameter is unrecognized.</p> |
| <p>*** ERROR, RESPECIFIED CONTROL, IGNORED The indicated command-line control was specified twice.</p> |
| <p>*** ERROR, CAN'T OPEN FILE <i>filename</i> The specified file cannot be open for read.</p> |
| <p>*** ERROR, CAN'T CREATE FILE <i>filename</i> The specified file cannot be open for write.</p> |

Error Message***** I/O-ERROR ON FILE *filename***

A read/write error occurred during access of the specified file.

***** ERROR: PREMATURE END OF FILE ON *filename***

The input file does not end correctly. This is usually a result of a previous fatal error of an translator or linker/locater.

***** ERROR: MORE THAN 512 CLASSES ON *filename***

The input file contains more than 512 memory classes. This is the limit of **OHx51**.

***** ERROR, NON-NUL ARGUMENT EXPECTED**

An argument is missing.

Warning Message**WARNING: <PUBDEF> HEX-FILE WILL BE INVALID**

The absolute object file still contains public definitions. This warning usually indicates that the object file has not been processed by the **Lx51** linker/locator. The hex file that is produced may be invalid.

WARNING: <EXTDEF> UNDEFINED EXTERNAL

The absolute object file still contains external definitions. This warning usually indicates that the object file has not been processed by the **Lx51** linker/locator. The hex file that is produced may be invalid.

WARNING: <FIXUPP> HEX-FILE WILL BE INVALID

The absolute object file still contains fix-ups. This warning usually indicates that the object file has not been processed by the **L251** linker/locator. The hex file that is produced may be invalid.

Using OC51

The **BL51** linker/locator generates a banked object file for programs that use bank switching. Banked object files contain several banks of code that reside at the same physical location. These object files can be converted into standard object files using the **OC51** Banked Object File Converter.

The **OC51** Banked Object File Converter will create an absolute object file for each code bank represented in the banked object file. Symbolic debugging information that was included in the banked object file will be copied to the absolute object modules that are generated. Once you have created absolute object files with OC51, you may use the OH51 Object-Hex Converter to create Intel HEX files for each absolute object file.

The OC51 Banked Object File Converter is invoked from the command prompt by typing **OC51** along with the name of the banked object file. The command line format is:

```
OC51 banked_obj_file
```

where

banked_obj_file is the name of the banked object file that is generated by the **BL51** linker/locator.

OC51 will create separate absolute object modules for each code bank represented in the banked object file. The absolute object modules will be created with a filename consisting of the *basename* of the banked object file combined with the file extension *Bnn* where *nn* corresponds to the bank number 00 - 31. For example:

```
OC51 MYPROG
```

creates the absolute object files **MYPROG.B00** for code bank 0, **MYPROG.B01** for code bank 1, **MYPROG.B02** for code bank 2, etc.

NOTE

Use the **OC51** Banked Object File Converter only if you used the **BANKx** control on the **BL51** linker/locator command line. If your program does not use code banking, do not use **OC51**.

OC51 Error Messages

The following table lists the errors that you may encounter when you use the OC51 Banked Object File Converter. Each message includes a brief description of the message as well as corrective actions you can take to eliminate the error condition.

| Error | Error Message and Description |
|-------|---|
| 201 | FILE ACCESS ERROR ON INPUT FILE FILE: <i>filename</i> An error occurred while reading the specified file. |
| 202 | FILE ACCESS ERROR ON OUTPUT FILE FILE: <i>filename</i> An error occurred while writing the specified file. |
| 203 | NOT A BANKED 8051 OBJECT FILE The input file is not a banked object file. |
| 204 | INVALID INPUT FILE The input file has an invalid format. |
| 205 | CHECKSUM ERROR The input file has an invalid checksum. This error is usually caused by an error from BL51 . Make sure that your program was linked successfully. |
| 206 | INTERNAL ERROR OC51 has detected an internal error. Contact technical support. |
| 207 | SCOPE LEVEL ERROR MODULE: <i>modulename</i> The symbolic information in the specified file contains errors. This error message is usually the result of an error at link time. Make sure that your program was linked successfully. |
| 208 | PATH OR FILE NOT FOUND FILE: <i>filename</i> The OC51 Banked Object File Converter cannot find the specified file. Make sure the file actually exists. |

Intel HEX File Format

The Intel HEX file is an ASCII text file with lines of text that follow the Intel HEX file format. Each line in an Intel HEX file contains one HEX record. These records are made up of hexadecimal numbers that represent machine language code and/or constant data. Intel HEX files are often used to transfer the program and data that would be stored in a ROM or EPROM. Most EPROM programmers or emulators can use Intel HEX files.

11

Record Format

An Intel HEX file is composed of any number of HEX records. Each record is made up of five fields that are arranged in the following format:

```
:11aaaaatt[dd...]cc
```

Each group of letters corresponds to a different field, and each letter represents a single hexadecimal digit. Each field is composed of at least two hexadecimal digits—which make up a byte—as described below:

| | | | | | | | | | |
|------|---|----|-------------|----|--------------------|----|---------------------------------------|----|---------------------------------|
| : | is the colon that starts every Intel HEX record. | | | | | | | | |
| 11 | is the record-length field that represents the number of data bytes (aa) in the record. | | | | | | | | |
| aaaa | is the address field that represents the starting address for subsequent data in the record. | | | | | | | | |
| tt | is the field that represents the HEX record type, which may be one of the following: <table style="margin-left: 40px;"> <tr> <td>00</td> <td>data record</td> </tr> <tr> <td>01</td> <td>end-of-file record</td> </tr> <tr> <td>02</td> <td>extended 8086 segment address record.</td> </tr> <tr> <td>04</td> <td>extended linear address record.</td> </tr> </table> | 00 | data record | 01 | end-of-file record | 02 | extended 8086 segment address record. | 04 | extended linear address record. |
| 00 | data record | | | | | | | | |
| 01 | end-of-file record | | | | | | | | |
| 02 | extended 8086 segment address record. | | | | | | | | |
| 04 | extended linear address record. | | | | | | | | |
| dd | is a data field that represents one byte of data. A record may have multiple data bytes. The number of data bytes in the record must match the number specified by the 11 field. | | | | | | | | |
| cc | is the checksum field that represents the checksum of the record. The checksum is calculated by summing the values | | | | | | | | |

of all hexadecimal digit pairs in the record modulo 256 and taking the two's complement.

Data Record

The Intel HEX file is made up of any number of data records that are terminated with a carriage return and a linefeed. Data records appear as follows:

```
:10246200464C5549442050524F46494C4500464C33
```

where:

| | |
|-----------------|--|
| 10 | is the number of data bytes in the record. |
| 2462 | is the address where the data are to be located in memory. |
| 00 | is the record type 00 (a data record). |
| 464C . . . 464C | is the data. |
| 33 | is the checksum of the record. |

11

End-of-File (EOF) Record

An Intel HEX file must end with an end-of-file (EOF) record. This record must have the value 01 in the record type field. An EOF record always appears as follows:

```
:00000001FF
```

where:

| | |
|------|--|
| 00 | is the number of data bytes in the record. |
| 0000 | is the address where the data are to be located in memory. The address in end-of-file records is meaningless and is ignored. An address of 0000h is typical. |
| 01 | is the record type 01 (an end-of-file record). |
| FF | is the checksum of the record and is calculated as $01h + \text{NOT}(00h + 00h + 00h + 01h)$. |

Extended 8086 Segment Record

The Intel HEX contains extended 8086 segment records when the H86 directive is used. This record is used to specify an address offset (in 8086 paragraph form) for the following data records. Extended 8086 segment records appear as follows:

```
:02000002F0000C
```

where:

| | |
|------|---|
| 02 | is the number of data bytes in the record. |
| 0000 | is always 0 in a extended 8086 segment record. |
| 02 | is the record type 02 (a extended 8086 segment record). |
| F000 | is the offset in 8086 paragraph notation (= 0x0F0000). |
| 0C | is the checksum of the record. |

Extended Linear Address Record

The Intel HEX contains extended linear address records when the H386 directive is used. This record is used to specify the two most significant bytes (bits 16 - 31) of the absolute address. This address offset is used for all following data records. Extended linear address records appear as follows:

```
:0200000400FFFB
```

where:

| | |
|------|---|
| 02 | is the number of data bytes in the record. |
| 0000 | is always 0 in a extended 8086 segment record. |
| 04 | is the record type 04 (a extended linear address record). |
| 00FF | is the high word of the address offset (= 0xFF0000). |
| FB | is the checksum of the record. |

Example Intel HEX File

Following is an example of a complete Intel HEX file:

```
:0200000400FFFB  
:03000000020003F8  
:10000300758107758920758DFDD28E759852C20052  
:0B00130090001E12003612002B80F53A  
:0D001E00544553542050524F4752414D005D  
:10002B00740D120047740A12004722200004E49357  
:0C003B008001E06006120047A380F02264  
:080047003099FDC299F59922E0  
:00000001FF
```

Appendix A. Application Examples

A

This chapter illustrates project development for the **x51** microcontroller family. The sample programs are found in the `C:\KEIL\C51\EXAMPLES\` or `C:\KEIL\C251\EXAMPLES\` folder. Each sample program is stored in a separate folder along with μ Vision2 project files that help you quickly build each sample program.

The following table lists the sample programs that are discussed in the following section and their folder names.

| Example | Description |
|-------------------------------------|---|
| ASM | This section describes a short x51 program, developed in assembler language. The program displays the text "PROGRAM TEST" on the serial interface. |
| CSAMPLE | Simple addition and subtraction calculator that shows how to build a C application. |
| BANK_EX1 | C application for a classic 8051 device that shows code banking. |
| BANK_EX2 | C program for a classic 8051 device that stores constants in different code banks. |
| BANK_EX3 | Intel PL/M-51 application that uses code banking. |
| Philips 80C51MX \ASM | Assembler example that demonstrates the new instructions of the Philips 80C51MX. |
| Philips 80C51MX \Banking | C Compiler example that shows how to use the extended address space of the Philips 80C51MX. |

The folder **EXAMPLES** contains several other example programs that are described in the *μ Vision2 for the x51 Family* User's Guide.

ASM – Assembler Example

This section shows you how to create a **x51** program, developed in assembler language. The program outputs the text "PROGRAM TEST" on the serial interface. The program consists of three modules that can be translated using the various tool versions.

A

Using A51 and BL51

The following commands are required to translate and link the ASM example with the A51 macro assembler and the BL51 linker/locator. The output file can be converted into an Intel HEX file with the OH51 hex file converter.

```
A51 ASAMPLE1.A51 DEBUG XREF
A51 ASAMPLE2.A51 DEBUG XREF
A51 ASAMPLE3.A51 DEBUG XREF
```

The **XREF** control causes the A51 assembler to include in the listing (LST) files a cross reference report of the symbols used in the module. The **DEBUG** control includes complete symbol information in the object file.

After assembly, the files are linked by the **BL51** linker/locator with:

```
BL51 ASAMPLE1.OBJ, ASAMPLE2.OBJ, ASAMPLE3.OBJ PRECEDE (VAR1) IXREF
```

In the above linker command line, the **PRECEDE** control locates the VAR1 segment before other internal data memory segments. The **IXREF** control includes a cross reference report of all public and external symbols in the linker listing (M51) file. The linker creates an absolute object module that is stored in the file **ASAMPLE1**. This file can be used as input for debuggers or may be used to create an Intel HEX file using the **OH51** object hex converter with the following command:

```
OH51 ASAMPLE1
```

Using AX51 and LX51

The commands for translating the application with the AX51 macro assembler and the LX51 linker/locater are:

```
AX51 ASAMPLE1.A51  DEBUG XREF
AX51 ASAMPLE2.A51  DEBUG XREF
AX51 ASAMPLE3.A51  DEBUG XREF
```

After assembly, the files are linked by the **LX51** linker/locater with:

```
LX51 ASAMPLE1.OBJ, ASAMPLE2.OBJ, ASAMPLE3.OBJ SEGMENTS (VAR1) IXREF
```

The **SEGMENTS** control replaces the **PRECEDE** control used in the **BL51** command line to locate the **VAR1** segment before other internal data memory segments. The **IXREF** control includes a cross reference in the linker listing (MAP) file. The file **ASAMPLE1** is the absolute object module created by the linker. This file can be used as input for debuggers or may be converted into an Intel HEX file using **OHX51** with the following command:

```
OHX51 ASAMPLE1
```

Using A251 and L251

The Intel/Atmel WM 251 application is build with the following commands:

```
A251 ASAMPLE1.A51  DEBUG XREF
A251 ASAMPLE2.A51  DEBUG XREF
A251 ASAMPLE3.A51  DEBUG XREF
```

```
L251 ASAMPLE1.OBJ, ASAMPLE2.OBJ, ASAMPLE3.OBJ SEGMENTS (VAR1) IXREF
```

The **SEGMENTS** control locates the **VAR1** segment before other internal data memory segments. The **IXREF** control includes a cross reference in the linker listing (MAP) file. The file **ASAMPLE1** is the absolute object module created by the linker. This file can be used as input for debuggers or may be converted into an Intel HEX file using **OH251** with the following command:

```
OH251 ASAMPLE1
```

A

CSAMPLE – C Compiler Example

This section describes shows a **x51** program, developed with the **Cx51** compiler. This program demonstrates the concept of modular programming development and can be translated using the various tool versions.

The program calculates the sum of two input numbers and displays the result. Numbers are input with the **getchar** library function and results are output with the **printf** library function. The program consists of three source modules, which are translated using the following command lines.

Using C51 and BL51

The following commands are required to translate and link the C example with the C51 compiler and the BL51 linker/locator. The output file can be converted into an Intel HEX file with the OH51 hex file converter.

```
C51 CSAMPLE1.C DEBUG OBJECTEXTEND
C51 CSAMPLE2.C DEBUG OBJECTEXTEND
C51 CSAMPLE3.C DEBUG OBJECTEXTEND
```

The **DEBUG** and **OBJECTEXTEND** control directs the compiler to include complete symbol information in the object file.

After compilation, the files are linked using the **BL51** linker/locator:

```
BL51 CSAMPLE1.OBJ, CSAMPLE2.OBJ, CSAMPLE3.OBJ PRECEDE (?DT?CSAMPLE3) IXREF
```

In the above linker command line, the **PRECEDE** control locates the **?DT?CSAMPLE3** segment before other internal data memory segments. The **IXREF** control includes a cross reference report in the linker listing (M51) file. The linker creates an absolute object module that is stored in the file **CSAMPLE1**. This file can be used as input for debuggers or may be used to create an Intel HEX file using the **OH51** object hex converter with the following command:

```
OH51 CSAMPLE1
```

Using C51 and LX51

The commands for translating the application with the C51 compiler and the LX51 linker/locater are:

```
C51 CSAMPLE1.C DEBUG OMF251
C51 CSAMPLE2.C DEBUG OMF251
C51 CSAMPLE3.C DEBUG OMF251
```

The **DEBUG** control directs the compiler to include symbol information in the object file. The **OMF251** control generates extended object files that support the extensions of the **LX51** linker/locater. The files are linked with:

```
LX51 CSAMPLE1.OBJ, CSAMPLE2.OBJ, CSAMPLE3.OBJ SEGMENTS (?DT?CSAMPLE3) IXREF
```

The **SEGMENTS** control replaces the **PRECEDE** control used in the **BL51** command line to locate the **?DT?CSAMPLE3** segment before other internal data memory segments. The **IXREF** control includes a cross reference in the linker listing (MAP) file. The file **CSAMPLE1** is the absolute object module created by the linker. This file can be used as input for debuggers or may be converted into an Intel HEX file using **OHX51** with the following command:

```
OHX51 CSAMPLE1
```

Using C251 and L251

The Intel/Atmel WM 251 application is build with the following commands:

```
C251 CSAMPLE1.C DEBUG
C251 CSAMPLE2.C DEBUG
C251 CSAMPLE3.C DEBUG
```

After assembly, the files are linked by the **L251** linker/locator with:

```
L251 CSAMPLE1.OBJ, CSAMPLE2.OBJ, CSAMPLE3.OBJ SEGMENTS (?DT?CSAMPLE3) IXREF
```

The **SEGMENTS** control locates the **?DT?CSAMPLE3** segment before other internal data memory segments. The **IXREF** control includes a cross reference in the linker listing (MAP) file. The file **CSAMPLE1** is the absolute object module created by the linker. This file can be used as input for debuggers or may be converted into an Intel HEX file using **OH251** with the following command:

```
OH251 CSAMPLE1
```

A

BANK_EX1 – Code Banking with C51

The following C51 example shows how to compile and link a program using multiple code banks.

The program begins with function **main** in **C_ROOT.C**. The **main** function calls functions in other code banks. These functions, in turn, call functions in yet different code banks. The **printf** function outputs the number of the code bank in each function.

Using C51 and BL51

The program can be translated using the following commands:

```
C51 C_ROOT.C    DEBUG OBJECTTEXTEND
C51 C_BANK0.C  DEBUG OBJECTTEXTEND
C51 C_BANK1.C  DEBUG OBJECTTEXTEND
C51 C_BANK2.C  DEBUG OBJECTTEXTEND
```

C_ROOT.C contains the **main** function and is located in the common area. **C_BANK0.C**, **C_BANK1.C**, and **C_BANK2.C** contain the bank functions and are located in the bank area. The **BL51** linker/locator is invoked as follows:

```
BL51 COMMON{C_ROOT.OBJ}, BANK0{C_BANK0.OBJ},
      BANK1{C_BANK1.OBJ}, BANK2{C_BANK2.OBJ}
      BANKAREA(8000H,0FFFFH)
```

The **BANKAREA(8000H,0FFFFH)** control defines the address space 80000H to 0FFFFH as the area for code banks. The **COMMON** control places the **C_ROOT.OBJ** module in the common area. The **BANK0**, **BANK1**, and **BANK2** controls place modules in bank 0, 1, and 2 respectively.

The **BL51** linker/locator creates a listing file, **C_ROOT.M51**, which contains information about memory allocation and about the intra-bank jump table that is generated. **BL51** also creates the output file **C_ROOT** that in banked object file format. You must use the **OC51** banked object file converter to convert this file into standard object files:

```
OC51 C_ROOT
```

For this example program, the **OC51** banked object file converter produces three standard object files from **C_ROOT**. They are listed in the following table.

| Filename | Contents |
|-------------------|--|
| C_ROOT.B00 | All information (including symbols) for code bank 0 and the common area. |
| C_ROOT.B01 | Information for code bank 1 and the common area. |
| C_ROOT.B02 | Information for code bank 2 and the common area. |

You can create Intel HEX files for each of these object files by using the **OH51** object to hex converter. The Intel HEX files you create with **OH51** contain complete information for each code bank including the common area:

```
OH51 C_ROOT.B00 HEXFILE (C_ROOT.H00)
OH51 C_ROOT.B01 HEXFILE (C_ROOT.H01)
OH51 C_ROOT.B02 HEXFILE (C_ROOT.H02)
```

A

Using C51 and LX51

When you are using the extended LX51 linker/locater the program is generated as shown below:

```
C51 C_ROOT.C      DEBUG OMF251
C51 C_BANK0.C    DEBUG OMF251
C51 C_BANK1.C    DEBUG OMF251
C51 C_BANK2.C    DEBUG OMF251

LX51 COMMON{C_ROOT.OBJ}, BANK0{C_BANK0.OBJ},
      BANK1{C_BANK1.OBJ}, BANK2{C_BANK2.OBJ}
      BANKAREA(8000H,0FFFFH)
```

The **LX51** linker/locator creates a listing file, **C_ROOT.MAP**, which contains information about memory allocation and about the intra-bank jump table that is generated. The linker output file **C_ROOT** can be directly converted into an Intel HEX file with **OHX51**:

```
OHX51 C_ROOT
```

BANK_EX2 – Banking with Constants

This example shows how to place constants in code banks. You can use this technique to place messages or large tables in code banks other than the one in which your program resides. This example uses three source files: `C_PROG.C`, `C_MESS0.C`, and `C_MESS1.C`.

You use the **LX51** linker/locator to locate constant segments in particular code banks. Segment names for constant data have the general format `?CO?modulename` where *modulename* is the name of the source file the constant data is declared.

In your C51 programs, when you access constant data that is in a different segment, you must manually ensure that the proper code bank is used when accessing that constant data. You do this with the **switchbank** function. This function is defined in the `L51_BANK.A51` source module.

Using C51 and BL51

These source files are compiled and linked using the following commands.

```
C51 C_PROG.C      DEBUG OBJECTTEXTEND
C51 C_MESS0.C    DEBUG OBJECTTEXTEND
C51 C_MESS1.C    DEBUG OBJECTTEXTEND

BL51 C_PROG.OBJ, C_MESS0.OBJ, C_MESS1.OBJ
      BANKAREA(8000H,0FFFFH) &
      BANK0(?CO?C_MESS0 (8000H)) BANK1(?CO?C_MESS1 (8000H))

OC51 C_PROG
OH51 C_PROG.B00 HEXFILE (C_PROG.H00)
OH51 C_PROG.B01 HEXFILE (C_PROG.H01)
```

A

Using C51 and LX51

When you are using the extended LX51 linker/locator the program is generated as shown below:

```
C51 C_PROG.C      DEBUG OMF251
C51 C_MESS0.C    DEBUG OMF251
C51 C_MESS1.C    DEBUG OMF251

LX51 C_PROG.OBJ, C_MESS0.OBJ, C_MESS1.OBJ
      BANKAREA(8000H,0FFFFH) &
      SEGMENTS (?CO?C_MESS0 (B0:8000H)) BANK1(?CO?C_MESS1 (B1:8000H))

OHX51 C_PROG
```

BANK_EX3 – Code Banking with PL/M-51

The following PL/M-51 example shows how to compile and link a PL/M-51 program using multiple code banks. The function of this example is similar to that shown in “BANK_EX1 – Code Banking with C51” on page 404.

The program begins with the procedure in `P_ROOT.P51`. This routine calls routines in other code banks, which, in turn, call routines in yet different code banks.

The PL/M-51 programs are compiled using the following commands.

```
PLM51 P_ROOT.P51  DEBUG
PLM51 P_BANK0.P51 DEBUG
PLM51 P_BANK1.P51 DEBUG
PLM51 P_BANK2.P51 DEBUG
```

In this example, `P_ROOT.OBJ` is located in the common area and `P_BANK0.OBJ`, `P_BANK1.OBJ`, and `P_BANK2.OBJ` are located in the bank area.

NOTE

The PL/M-51 runtime library, `PLM51.LIB`, must be included in the linkage. You must either specify a path to the directory in which this library is stored, or you must include it directly in the linker command line.

Using BL51

The **BL51** linker/locator is invoked as follows:

```
BL51 COMMON{P_ROOT.OBJ}, BANK0{P_BANK0.OBJ}, &
      BANK1{P_BANK1.OBJ}, BANK2{P_BANK2.OBJ} &
      BANKAREA(8000H, 0FFFFH)
```

The **BANKAREA (8000H, 0FFFFH)** control defines the address space 8000H to 0FFFFH as the area for code banks. The **COMMON** control places the **P_ROOT.OBJ** module in the common area. The **BANK0**, **BANK1**, and **BANK2** controls place modules in bank 0, 1, and 2 respectively.

The **BL51** linker/locator creates a listing file, **P_ROOT.M51**, which contains information about memory allocation and about the intra-bank jump table that is generated. **BL51** also creates the output module, **P_ROOT**, which is stored in banked OMF format. You must use the **OC51** banked object file converter to convert the banked OMF file into standard OMF files. OMF files may be loaded with the μ Vision2 Debugger/Simulator or an in-circuit emulator. Invoke the **OC51** banked object file converter as follows:

```
OC51 P_ROOT
```

For this example program, the **OC51** banked object file converter produces three standard OMF-51 files from **P_ROOT**. They are listed in the following table.

| Filename | Contents |
|-------------------|--|
| P_ROOT.B00 | All information (including symbols) for code bank 0 and the common area. |
| P_ROOT.B01 | Information for code bank 1 and the common area. |
| P_ROOT.B02 | Information for code bank 2 and the common area. |

You can create Intel HEX files for each of these OMF-51 files by using the **OH51** object to hex converter. The Intel HEX files you create with **OH51** contain complete information for each code bank including the common area. Intel HEX files can be generated using the following **OH51** object to hex converter command line.

```
OH51 P_ROOT.B00 HEXFILE (P_ROOT.H00)
OH51 P_ROOT.B01 HEXFILE (P_ROOT.H01)
OH51 P_ROOT.B02 HEXFILE (P_ROOT.H02)
```

A

Using C51 and LX51

When you are using the extended LX51 linker/locater the program is generated as shown below:

```
LX51 COMMON{P_ROOT.OBJ}, BANK0{P_BANK0.OBJ},  
      BANK1{P_BANK1.OBJ}, BANK2{P_BANK2.OBJ}  
      BANKAREA(8000H,0FFFFH)  
  
OHX51 P_ROOT
```

Philips 80C51MX – Assembler Example

The example **Philips 80C51MX\ASM** shows how to use the new instructions of the Philips 80C51MX architecture in assembly language. Segments with the memory class **ECODE** are used to show the ECALL and ERET instructions. Segments with **HCONST** and **HDATA** are used to show how to access memory in the 16MB address space of this architecture.

The example program is build with the **AX51** macro assembler and the **LX51** linker/locater as shown below:

```
AX51 MX_INST.A51 DEBUG MOD_MX51  
  
LX51 MX_INST.OBJ  
  
OHX51 MX_INST
```

Philips 80C51MX – C Compiler Example

The example **Philips 80C51MX\Banking** shows how to create large C programs for the Philips 80C51MX architecture. The program uses the code banking facilities of the **LX51** linker/locater to place program code into the code pages 0x80:0000 (bank 0) and 0x81:0000 (bank 1). The function of this example is similar to that shown in “BANK_EX1 – Code Banking with C51” on page 404. In addition some variables are declared with the *far* memory type to show the usage of the HCONST and HDATA memory class.

The example program is build with the **AX51** macro assembler and the **LX51** linker/locater as shown below:

```
CX51 C_ROOT.C DEBUG
CX51 C_BANK0.C DEBUG
CX51 C_BANK1.C DEBUG
AX51 START_MX.A51 MOD_MX51

LX51 COMMON {C_ROOT.OBJ, START_MX.OBJ},
           BANK0 {C_BANK0.OBJ}, BANK1 {C_BANK1.OBJ}
           CLASSES (HCONST (0x810000 - 0x81FFFF), HDATA (0x010000 - 0x01FFFF))

OHX51 C_ROOT
```



A

Appendix B. Reserved Symbols

The **Ax51** assembler uses predefined or reserved symbols that may not be redefined in your program. Reserved symbol names include instruction mnemonics, directives, operators, and register names. The following lists the reserved symbol names that are found in all **Ax51** variants:

| | | | | |
|----------------|---------|--------|-------------|---------|
| A | DA | INPAGE | MOD | REPT |
| AB | DATA | INSEG | MOV | RET |
| ACALL | DB | IRP | MOVX | RETI |
| ADD | DBIT | IRPC | MOVX | RL |
| ADDC | DEC | ISEG | MUL | RLC |
| AJMP | DIV | JB | NAME | RR |
| AND | DJNZ | JBC | NE | RRC |
| ANL | DPTR | JC | NOP | RSEG |
| AR0 | DS | JE | NOT | SEG |
| AR1 | DSEG | JG | NUL | SEGMENT |
| AR2 | DW | JLE | NUMBER | SET |
| AR3 | ELSE | JMP | OR | SETB |
| AR4 | ELSEIF | JNB | ORG | SHL |
| AR5 | END | JNC | ORL | SHR |
| AR6 | ENDIF | JNE | OVERLAYABLE | SJMP |
| AR7 | ENDM | JNZ | PAGE | SUB |
| BIT | ENDP | JSG | PC | SUBB |
| BITADDRESSABLE | EQ | JSGE | POP | SWAP |
| BLOCK | EQU | JSL | PUBLIC | UNIT |
| BSEG | EXITM | JSLE | PUSH | USING |
| C | EXTRN | JZ | R0 | XCH |
| CALL | GE | LCALL | R1 | XCHD |
| CJNE | GT | LE | R2 | XDATA |
| CLR | HIGH | LJMP | R3 | XOR |
| CMP | IDATA | LOCAL | R4 | XRL |
| CODE | IF | LOW | R5 | XSEG |
| CPL | INBLOCK | LT | R6 | |
| CSEG | INC | MACRO | R7 | |

The **A51** assembler defines the following additional reserved symbols which are special function registers (SFR) of the classic 8051 CPU. These SFR definitions may be disabled using the **NOMOD51** control. The predefined SFR symbols are reserved symbols and may not be redefined in your program.

| | | | | |
|-------|------|-----|------|------|
| AC | IE | PS | SBUF | TI |
| ACC | IE0 | PSW | SCON | TL0 |
| B | IE1 | PT0 | SM0 | TL1 |
| CY | INT0 | PT1 | SM1 | TMOD |
| DPH | INT1 | PX0 | SM2 | TO |
| DPL | IT0 | PX1 | SP | TR0 |
| EA | IT1 | RB8 | T1 | TR1 |
| ES | OV | RD | TB8 | TXD |
| ET0 | P | REN | TCON | WR |
| ET1 } | P0 | RI | TF0 | |
| EX0 | P1 | RS0 | TF1 | |
| EX1 | P2 | RS1 | TH0 | |
| F0 | P3 | RXD | TH1 | |

The **AX51** assembler defines the following additional reserved symbols which comprise the additional instructions and registers of the Philips 80C51MX architecture.

| | | | | |
|-------|-------|--------|--------|-------|
| AT | DD | EDATA | FAR | OFFS |
| BYTE | DSB | EJMP | HCONST | PR0 |
| BYTE0 | DSD | EMOV | HDATA | PR1 |
| BYTE1 | DSW | EPTR | LABEL | PROC |
| BYTE2 | DWORD | ERET | LIT | WORD |
| BYTE3 | ECALL | EVEN | MBYTE | WORD0 |
| CONST | ECODE | EXTERN | NEAR | WORD2 |

The **A251** assembler defines the following additional reserved symbols which comprise the additional instructions and registers of the Intel and Atmel WM 251 architectures.

| | | | | |
|-------|-----------------|--------|-------|------|
| AT | DR56 | EXTERN | R12 | WR12 |
| BYTE | DR60 | FAR | R13 | WR14 |
| BYTE0 | DR8 | HCONST | R14 | WR16 |
| BYTE1 | DSB | HDATA | R15 | WR18 |
| BYTE2 | DSD | LABEL | R8 | WR2 |
| BYTE3 | DSW | LIT | R9 | WR20 |
| CONST | DWORD | MOVH | SLL | WR22 |
| DD | EBIT | MOV5 | SRA | WR24 |
| DR0 | EBITADDRESSABLE | MOVZ | SRL | WR26 |
| DR12 | ECALL | NCONST | TRAP | WR28 |
| DR16 | ECODE | NEAR | WORD | WR30 |
| DR20 | EDATA | OFFS | WORD0 | WR4 |
| DR24 | EJMP | PROC | WORD2 | WR6 |
| DR28 | ERET | R10 | WR0 | WR8 |
| DR4 | EVEN | R11 | WR10 | |

Appendix C. Listing File Format

This appendix describes the format of the listing file generated by the assembler.

Assembler Listing File Format

The **Ax51** assembler, unless overridden by controls, outputs two files: an object file and a listing file. The object file contains the machine code. The listing file contains a formatted copy of your source code with page headers and, if requested through controls (**SYMBOL** or **XREF**), a symbol table.

Sample Ax51 Listing

```

A251 MACRO ASSEMBLER ASAMPLE1                                25/01/2001 15:02:23 PAGE 1
A251 MACRO ASSEMBLER V1.40
OBJECT MODULE PLACED IN ASAMPLE1.OBJ
ASSEMBLER INVOKED BY: F:\RK\ZX\ASM\A251.EXE ASAMPLE1.A51 XREF

LOC   OBJ           LINE   SOURCE
      1             $NOMOD51
      2             $INCLUDE (REG52.INC)
+1    3             +1 $SAVE
+1   106           +1 $RESTORE
      107
      108           NAME     SAMPLE
      109
      110           EXTRN   CODE   (PUT_CRLF, PUTSTRING)
      111           PUBLIC  TXTBIT
      112
-----
      113           PROG   SEGMENT CODE
-----
      114           PCONST SEGMENT CODE
-----
      115           VAR1   SEGMENT DATA
-----
      116           BITVAR SEGMENT BIT
-----
      117           STACK  SEGMENT IDATA
      118
-----
      119           RSEG   STACK
000000      120           DS    10H ; 16 Bytes Stack
      121
000000      122           CSEG  AT  0
      123           USING  0 ; Register-Bank 0
      124           ; Execution starts at address 0 on power-up.
000000 020000      F      125           JMP   START
      126
-----
      127           RSEG   PROG
      128           ; first set Stack Pointer
000000 758100      F      129           START: MOV  SP,#STACK-1
      130
      131           ; Initialize serial interface
      132           ; Using TIMER 1 to Generate Baud Rates
      133           ; Oscillator frequency = 11.059 MHz
000003 758920      134           MOV  TMOD,#00100000B ;C/T = 0, Mode = 2
000006 758DFD      135           MOV  TH1,#0FDH
000009 D28E        136           SETB TR1
00000B 759852      137           MOV  SCON,#01010010B
      138

```

```

00000E C200      F      139      ; clear TXTBIT to read form CODE-Memory
                  140          CLR   TXTBIT
                  141
                  142      ; This is the main program. It is a loop,
                  143      ; which displays the a text on the console.
000010          144      REPEAT:
                  145      ; type message
000010 900000      F      146          MOV   DPTR,#TXT
000013 120000      E      147          CALL  PUTSTRING
000016 120000      E      148          CALL  PUT_CRLF
                  149      ; repeat
000019 8000       F      150          SJMP  REPEAT
                  151      ;
-----         152          RSEG  PCONST
000000 54455354      153      TXT:   DB    'TEST PROGRAM',00H
000004 2050524F
000008 4752414D
00000C 00

                  154
                  155      ; only for demonstration
-----         156          RSEG  VAR1
000000          157      DUMMY: DS    21H
                  158
                  159      ; TXTBIT = 0 read text from CODE Memory
                  160      ; TXTBIT = 1 read text from XDATA Memory
-----         161          RSEG  BITVAR
0000.0          162      TXTBIT: DBIT 1
                  163
                  164          END

```

XREF SYMBOL TABLE LISTING

| N A M E | T Y P E | V A L U E | ATTRIBUTES / REFERENCES |
|--------------------|---------|-----------|---------------------------------|
| BITVAR | B SEG | 000001H | REL=UNIT, ALN=BIT 116# 161 |
| DUMMY. | D ADDR | 000000H R | SEG=VAR1 157# |
| PCONST | C SEG | 00000DH | REL=UNIT, ALN=BYTE 114# 152 |
| PROG | C SEG | 00001BH | REL=UNIT, ALN=BYTE 113# 127 |
| PUTSTRING. | C ADDR | ----- | EXT 110# 147 |
| PUT_CRLF | C ADDR | ----- | EXT 110# 148 |
| REPEAT | C ADDR | 000010H R | SEG=PROG 144# 150 |
| SAMPLE | | 108 | |
| STACK. | I SEG | 000010H | REL=UNIT, ALN=BYTE 117# 119 129 |
| START. | C ADDR | 000000H R | SEG=PROG 125 129# |
| TXT. | C ADDR | 000000H R | SEG=PCONST 146 153# |
| TXTBIT | B ADDR | 0000H.0 R | SEG=BITVAR 111 140 162# |
| VAR1 | D SEG | 000021H | REL=UNIT, ALN=BYTE 115# 156 |

REGISTER BANK(S) USED: 0

ASSEMBLY COMPLETE. 0 WARNING(S), 0 ERROR(S)

Listing File Heading

Every page has a header on the first line. It contains the words **Ax51 MACRO ASSEMBLER** followed by the title, if specified. If the title is not specified, then the module name is used. It is derived from the **NAME** directive (if specified), or from the root of the source filename. On the extreme right side of the header, the date (if specified) and the page number are printed.

In addition to the normal header, the first page of listing includes the **Ax51** listing file header. This header shows the assembler version number, the file name of the object file, if any, and the entire invocation line.

Source Listing

The main body of the listing file is the formatted source listing. A section of formatted source is shown in the following.

Sample Source Listing

| LOC | OBJ | LINE | SOURCE |
|--------|--------|------|----------------|
| 000006 | 758DFD | 135 | MOV TH1, #0FDH |

The format for each line in the listing file depends on the source line that appears on it. Instruction lines contain 4 fields. The name of each field and its meanings is shown in the list below:

- **LOC** shows the location relative or absolute (code address) of the first byte of the instruction. The value is displayed in hexadecimal.
- **OBJ** shows the actual machine code produced by the instruction, displayed in hexadecimal. If the object that corresponds to the printed line is to be fixed up (it contains external references or is relocatable), an **F** or **E** is printed after the **OBJ** field. The object fields to be fixed up contain zeros.
- **LINE** shows the **INCLUDE** nesting level, if any, the number of source lines from the top of the program, and the macro nesting level, if any. All values in this field are displayed in decimal numbers.
- **SOURCE** shows the source line as it appears in the file. This line may be extended onto the subsequent lines in the listing file.

DB, **DW**, and **DD** directives are formatted similarly to instruction lines, except the **OBJ** field shows the data values placed in memory. All data values are shown. If the expression list is long, then it may take several lines in the listing file to display all of the values placed in memory. The extra lines will only contain the **LOC** and **OBJ** fields.

The directives that affect the location counter without initializing memory (e.g. **ORG**, **DBIT**, or **DS**) do not use the **OBJ** field, but the new value of the location counter is shown in the **LOC** field.

The **SET** and **EQU** directives do not have a **LOC** or **OBJ** field. In their place the assembler lists the value that the symbol is set to. If the symbol is defined to equal one of the registers, then **REG** is placed in this field. The remainder of the directive line is formatted in the same way as the other directives.

Macro / Include File / Save Stack Format

In the listing file, the assembler displays the macro nesting level, the include file level, and the level of the **SAVE/RESTORE** stack. These nesting levels are shown before and after the **LINE** number as shown in the following listing.

```

LOC   OBJ           LINE   SOURCE
                                1   $GEN      ; Enable Macro Listing
                                2
                                3   MYMACRO  MACRO      ; A sample macro
                                4   INC      A          ; Macro Level 1
                                5   MACRO2
                                6   ENDM
                                7
                                8   MACRO2  MACRO      ; Macro 2
                                9   NOP      ; Macro Level 2
                               10   ENDM
                               11
                               12
----- 13   MYPROG  SEGMENT CODE
----- 14   RSEG    MYPROG
                               15
000000 7400   16           MOV      A,#0
                               17   MYMACRO
000002 04     18+1      INC      A          ; Macro Level 1
                               19+1      MACRO2
000003 00     20+2      NOP      ; Macro Level 2
                               21   $INCLUDE (MYFILE.INC) ; A include file
                               +1 22   ; This is a comment ; Include Level 1
                               +1 23   MACRO2
000004 00     +1 24+1      NOP      ; Macro Level 1
000005 7401   25           MOV      A,#1
                               26 +1 $SAVE   ; Save Control
                               27 +1 MYMACRO ; SAVE Level 1
000007 04     28+1+1    INC      A          ; Macro Level 1
                               29+1+1    MACRO2
000008 00     30+2+1    NOP      ; Macro Level 2
                               31 +1 $RESTORE
000009 00     32           NOP
                               33   END

```



Symbol Table

The symbol table is a list of all symbols defined in the program along with the status information about the symbol. Any predefined symbols used will also be listed in the symbol table. If the XREF control is used, the symbol table will contain information about where the symbol was used in the program.

The status information includes a **NAME** field, a **TYPE** field, a **VALUE** field, and an **ATTRIBUTES** field.

The **TYPE** field specifies the type of the symbol: ADDR if it is a memory address, NUMB if it is a pure number (e.g., as defined by EQU), SEG if it is a relocatable segment, and REG if a register. For ADDR and SEG symbols, the segment type is added.

The **VALUE** field shows the value of the symbol when the assembly was completed. For REG symbols, the name of the register is given. For NUMB and ADDR symbols, their absolute value (or if relocatable, their offset) is given, followed by A (absolute) or R (relocatable). For SEG symbols, the segment size is given here. Bit address and size are given by the byte part, a period (.), followed by the bit part. The scope attribute, if any, is PUB (public) or EXT (external). These are given after the VALUE field.

The **ATTRIBUTES** field contains an additional piece of information for some symbols: relocation type for segments, segment name for relocatable symbols.

Example Symbol Table Listing

```

SYMBOL TABLE LISTING
-----
N A M E           T Y P E   V A L U E   A T T R I B U T E S
BITVAR . . . . . B   SEG   000001H   REL=UNIT, ALN=BIT
DUMMY. . . . . D   ADDR  000000H R   SEG=VAR1
PCONST . . . . . C   SEG   00000DH   REL=UNIT, ALN=BYTE
PROG . . . . . C   SEG   00001BH   REL=UNIT, ALN=BYTE
PUTSTRING. . . . . C   ADDR  -----   EXT
PUT_CRLF . . . . . C   ADDR  -----   EXT
REPEAT . . . . . C   ADDR  000010H R   SEG=PROG
SAMPLE . . . . .
STACK. . . . . I   SEG   000010H   REL=UNIT, ALN=BYTE
START. . . . . C   ADDR  000000H R   SEG=PROG
TXT. . . . . C   ADDR  000000H R   SEG=PCONST
TXTBIT . . . . . B   ADDR  0000H.0 R   SEG=BITVAR
VAR1 . . . . . D   SEG   000021H   REL=UNIT, ALN=BYTE

```

If the **XREF** control is used, then the symbol table listing will also contain all of the line numbers of each line of code that the symbol was used. If the value of the symbol was changed or defined on a line, then that line will have a hash mark (#) following it. The line numbers are displayed in decimal.

Listing File Trailer

At the end of the listing, the assembler prints a message in the following format:

```
REGISTER BANK(S) USED: [r r r r]  
ASSEMBLY COMPLETE. (n) WARNING(S), (m) ERROR(S)
```

where

- r* are the numbers of the register banks used.
- n* is the number of warnings found in the program.
- m* is the number of errors found in the program.

C

Appendix D. Assembler Differences

This appendix lists the differences between the Intel ASM-51 assembler, the Keil A51 assembler, and the Keil A251/AX51 assembler.

Differences Between A51 and A251/AX51

Assembly modules written for the A51 assembler may be assembled using the A251/AX51 macro assembler. However, since the A251 macro assembler supports the Intel/Atmel WM 251 architecture and the AX51 macro assembler supports extended 8051 variants like the Philips 80C51MX, the following incompatibilities may arise when A51 assembly modules are assembled with the A251/AX51 assembler.

- **32-Bit Values in Numeric Evaluations**

The A51 assembler uses 16-bit values for all numerical expressions. The A251/AX51 macro assembler uses 32-bit values. This may cause problems when overflows occur in numerical expressions. For example:

```
Value      EQU      (8000H + 9000H) / 2
```

generates the result 800h in A51 since the result of the addition is only a 16-bit value (1000h). However, the A251/AX51 assembler calculates a value of 8800h.

- **8051 Pre-defined Special Function Register Symbol Set**

The default setting of the A51 assembler pre-defines the Special Function Register (SFR) set of 8051 CPU. This default SFR set can be disabled with the A51 control **NOMOD51**. Both A251 and AX51 do not pre-define the 8051 SFR set. The control **NOMOD51** is accepted by A251/AX51 but does not influence any SFR definitions.

- **More Reserved Symbols**

The A251/AX51 macro assembler has more reserved symbols as A51. Therefore it might be necessary to change user-defined symbol names. For example the symbol ECALL cannot be used as label name in A251/AX51, since it is a mnemonic for a new instruction.

- **Object File Differences**

Ax51 uses the OMF-251/51MX file format for object files. A51 uses an extended version of the Intel OMF-51 file format. The OMF-51 file format limits the numbers of external symbols and segments to 256 per module. The OMF-251 file format does not have such a limit on the segment and external declarations.

Differences between A51 and ASM51

Assembly modules written for the Intel ASM51 macro assembler can be re-translated with the A51 macro assembler. However you have to take care about the following differences:

- **Enable the MPL Macro Language**

If your assembly module contains Intel ASM51 macros, the A51 MPL macros need to be enable with the **MPL** control.

- **8051 Pre-defined Interrupt Vectors**

The Intel ASM51 pre-defines the following symbol names if **MOD51** is active: **RESET**, **EXTI0**, **EXTI1**, **SINT**, **TIMER0**, **TIMER1**. A51 does not pre-define this symbol names.

- **More Reserved Symbols**

Since the A51 macro assembler supports also conditional assembly and standard macros, A51 has more reserved symbols then Intel ASM51. Therefore it might be necessary to change user-defined symbol names. For example the symbol **IF** cannot be used as label name in A51, since it is a control for conditional assembly.

- **Object File Differences**

The A51 assembler generates line number information for source level debugging and file dependencies. For compatibility to previous A51 versions and to ASM51, the line number information can be disabled with the A51 control **NOLINES**.

- **C Preprocessor Side Effects**

The integrated C preprocessor in **Ax51** has two side effects that are incompatible to the Intel ASM51 macro assembler. If you are using the backslash character at the end of a comment line, the next line will be comment out too. If you are using **\$INCLUDE** in conditional assembly blocks, the file must exist even when the block will not be assembled.

Differences between A251/AX51 & ASM51

Assembly modules written for Intel ASM51 can be re-translated with the A251 macro assembler. However, since the A251 macro assembler supports additional 251 features, the following incompatibilities can arise when ASM51 modules are re-translated with A251.

- **32-Bit Values in Numeric Evaluations**

The ASM51 assembler uses 16-bit numbers for all numerical expressions. The A251 macro assembler uses 32-bit values. This can cause problems when overflows occur in numerical expressions. For example:

```
Value EQU (8000H + 9000H) / 2
```

has the result 800H in ASM51 since the result of the addition is only a 16-bit value (1000H), whereas the A251 calculates Value as 8800H.

- **8051 Pre-defined Symbols**

The default setting of Intel ASM51 pre-defines the Special Function Register (SFR) set and symbol names for reset and interrupt vectors of 8051 CPU. This default symbol set can be disabled with the ASM51 control **NOMOD51**. A251 does not pre-define any of the 8051 SFR or interrupt vector symbols. The control **NOMOD51** is accepted by A251 but does not influence any symbol definitions.

- **More Reserved Symbols**

The A251 macro assembler has more reserved symbols as ASM51. Therefore it might be necessary to change user-defined symbol names. For example the symbol ECALL cannot be used as label name in A251, since the Intel/Atmel WM 251 has a new instruction with that mnemonic.

- **Enable the MPL Macro Language**

If your assembly module contains Intel ASM51 macros, the A251 MPL macros need to be enabled with the **MPL** control.

- **Object File Differences**

The A251 assembler uses the Intel OMF-251 file format for object files. The ASM51 assembler uses the Intel OMF-51 file format. The OMF-51 file format limits the numbers of external symbols and segments to 256 per module. The OMF-251 file format does not have such a limit on the segment and external declarations. The ASM51 assembler generates line number information for source level debugging. For compatibility with ASM51, line number information can be disabled with the A251 control **NOLINES**.

- **C Preprocessor Side Effects**

The integrated C preprocessor in **Ax51** has two side effects that are incompatible to the Intel ASM51 macro assembler. If you are using the backslash character at the end of a comment line, the next line will be comment out too. If you are using `$INCLUDE` in conditional assembly blocks, the file must exist even when the block will not be assembled.

Glossary

A51

The standard 8051 Macro Assembler.

AX51

The extended 8051 Macro Assembler.

A251

The 251 Macro Assembler.

ANSI

American National Standards Institute. The organization responsible for defining the C language standard.

argument

The value that is passed to a macro or function.

arithmetic types

Data types that are integral, floating-point, or enumerations.

array

A set of elements, all of the same data type.

ASCII

American Standard Code for Information Interchange. This is a set of 256 codes used by computers to represent digits, characters, punctuation, and other special symbols. The first 128 characters are standardized. The remaining 128 are defined by the implementation.

batch file

An ASCII text file containing commands and programs that can be invoked from the command line.

Binary-Coded Decimal (BCD)

A BCD (Binary-Coded Decimal) is a system used to encode decimal numbers in binary form. Each decimal digit of a number is encoded as a binary value 4 bits long. A byte can hold 2 BCD digits – one in the upper 4 bits (or nibble) and one in the lower 4 bits (or nibble).

BL51

The standard 8051 linker/locator.

block

A sequence of C statements, including definitions and declarations, enclosed within braces ({ }).

C51

The Optimizing C Compiler for classic 8051 and extended 8051 devices.

CX51

The Optimizing C Compiler for Philips 80C51MX architecture.

C251

The Optimizing C Compiler for Intel/Atmel WM 251.

constant expression

Any expression that evaluates to a constant non-variable value. Constants may include character and integer constant values.

control

Command line control switch to the compiler, assembler or linker.

declaration

A C construct that associates the attributes of a variable, type, or function with a name.

definition

A C construct that specifies the name, formal parameters, body, and return type of a function or that initializes and allocates storage for a variable.

directive

Instruction or control switch to the compiler, assembler or linker.

escape sequence

A backslash (\) character followed by a single letter or a combination of digits that specifies a particular character value in strings and character constants.

expression

A combination of any number of operators and operands that produces a constant value.

formal parameters

The variables that receive the value of arguments passed to a function.

function

A combination of declarations and statements that can be called by name to perform an operation and/or return a value.

function body

A block containing the declarations and statements that make up a function.

function call

An expression that invokes and possibly passes arguments to a function.

function declaration

A declaration providing the name and return type of a function that is explicitly defined elsewhere in the program.

function definition

A definition providing the name, formal parameters, return type, declarations, and statements describing what a function does.

function prototype

A function declaration that includes a list of formal parameters in parentheses following the function name.

in-circuit emulator (ICE)

A hardware device that aids in debugging embedded software by providing hardware-level single-stepping, tracing, and break-pointing. Some ICEs provide a trace buffer that stores the most recent CPU events.

include file

A text file that is incorporated into a source file.

keyword

A reserved word with a predefined meaning for the compiler or assembler.

L51

The **old** version of the 8051 linker/locator. L51 is replaced with the **BL51** linker/locator.

LX51

The extended 8051 linker/locator.

L251

The 251 linker/locator.

LIB51, LIBX51, LIB251

The commands to manipulate library files using the Library Manager.

library

A file that stores a number of possibly related object modules. The linker can extract modules from the library to use in building a target object file.

LSB

Least significant bit or byte.

macro

An identifier that represents a series of keystrokes.

manifest constant

A macro that is defined to have a constant value.

MCS[®] 51

The general name applied to the Intel family of 8051 compatible microprocessors.

MCS[®] 251

The general name applied to the Intel family of 251 compatible microprocessors.

memory model

Any of the models that specifies which memory areas are used for function arguments and local variables.

mnemonic

An ASCII string that represents a machine language opcode in an assembly language instruction.

MON51

An 8051 program that can be loaded into your target CPU to aid in debugging and rapid product development through rapid software downloading.

MON251

A 251 program that can be loaded into your target CPU to aid in debugging and rapid product development through rapid software downloading.

MSB

Most significant bit or byte.

newline character

A character used to mark the end of a line in a text file or the escape sequence ('**n**') to represent the newline character.

null character

ASCII character with the value 0 represented as the escape sequence (`'\0'`).

null pointer

A pointer that references nothing. A null pointer has the integer value 0.

object

An area of memory that can be examined. Usually used when referring to the memory area associated with a variable or function.

object file

A file, created by the compiler, that contains the program segment information and relocatable machine code.

OH51, OHX51, OH251

The commands to convert absolute object files into Intel HEX file format.

opcode

Also referred to as operation code. An opcode is the first byte of a machine code instruction and is usually represented as a 2-digit hexadecimal number. The opcode indicates the type of machine language instruction and the type of operation to perform.

operand

A variable or constant that is used in an expression.

operator

A symbol (e.g., +, -, *, /) that specifies how to manipulate the operands of an expression.

parameter

The value that is passed to a macro or function.

PL/M-51

A high-level programming language introduced by Intel at the beginning of the 1980's.

pointer

A variable containing the address of another variable, function, or memory area.

pragma

A statement that passes an instruction to the compiler at compile time.

preprocessor

The compiler's first pass text processor that manipulates the contents of a C file. The preprocessor defines and expands macros, reads include files, and passes control directives to the compiler.

relocatable

Object code that can be relocated and is not at a fixed address.

RTX51 Full

An 8051 Real-time Executive that provides a multitasking operating system kernel and library of routines for its use.

RTX51 Tiny

A limited version of RTX51.

RTX251 Full

An 251 Real-Time Executive that provides a multitasking operating system kernel and library of routines for its use.

scalar types

In C, integer, enumerated, floating-point, and pointer types.

scope

Sections of a program where an item (function or variable) can be referenced by name. The scope of an item may be limited to file, function, or block.

Special Function Register (SFR)

An SFR or Special Function Register is a register in the 8051 internal data memory space that is used to read and write to the hardware components of the 8051. This includes the serial port, timers, counters, I/O ports, and other hardware control registers.

source file

A text file containing C program or assembly program code.

stack

An area of memory, indirectly accessed by a stack pointer, that shrinks and expands dynamically as items are pushed onto and popped off of the stack. Items in the stack are removed on a LIFO (last-in first-out) basis.

static

A storage class that, when used with a variable declaration in a function, causes variables to retain their value after exiting the block or function in which they are declared.

stream functions

Routines in the library that read and write characters using the input and output streams.

string

An array of characters that is terminated with a null character ('\0').

string literal

A string of characters enclosed within double quotes (“ ”).

structure

A set of elements of possibly different types grouped together under one name.

structure member

One element of a structure.

token

A fundamental symbol that represents a name or entity in a programming language.

two's complement

A binary notation that is used to represent both positive and negative numbers. Negative values are created by complementing all bits of a positive value and adding 1.

type

A description of the range of values associated with a variable. For example, an **int** type can have any value within its specified range (-32768 to 32767).

type cast

An operation in which an operand of one type is converted to another type by specifying the desired type, enclosed within parentheses, immediately preceding the operand.

μVision2

An integrated software development platform that supports the Keil Software development tools. μVision2 combines Project Management, Source Code Editing, and Program Debugging in one environment.

whitespace character

Characters used as delimiters in C programs such as space, tab, and newline.

wild card

One of the characters (? or *) that can be used in place of characters in a filename.

Index

| | |
|------------------------------------|---------|
| !, macro operator | 149,154 |
| # | 157 |
| ## | 159 |
| #define | 157 |
| #elif | 157 |
| #else | 157 |
| #endif | 157 |
| #error | 157 |
| #if | 157 |
| #ifdef | 157 |
| #ifndef | 157 |
| #include | 157 |
| #line | 157 |
| #pragma | 157 |
| #undef | 157 |
| \$ | 87 |
| %, macro operator | 149,153 |
| &, macro operator | 149,151 |
| (, operator | 88 |
|), operator | 88 |
| *, operator | 88 |
| ; | 149,154 |
| -, operator | 88 |
| /, operator | 88 |
| __A251__ | 160 |
| __A51__ | 160 |
| __AX51__ | 160 |
| __DATE__ | 160 |
| __ERROR__, directive | 136 |
| __FILE__ | 160 |
| __INTR4__ | 230 |
| __KEIL__ | 160 |
| __LINE__ | 160 |
| __MODBIN__ | 230 |
| __MODSRC__ | 230 |
| __STDC__ | 160 |
| __TIME__ | 160 |
| +, operator | 88 |
| <, macro operator | 149,152 |
| <, operator | 89 |
| <=, operator | 89 |
| <>, operator | 89 |
| =, operator | 89 |
| >, macro operator | 149,152 |
| >, operator | 89 |
| >=, operator | 89 |
| µVision2 | |
| Create Library | 378 |
| µVision2 Linker Input | 269 |
| 251 | 34 |
| | |
| A | |
| <hr/> | |
| A, register | 75 |
| A251, defined | 427 |
| A51, defined | 427 |
| AB, register | 75 |
| Absolute Address Calculation | 262 |
| Absolute Object File | 262 |
| Absolute object files | 257 |
| ACALL | 82 |
| Add command | |
| library manager | 379 |
| Additional items, notational | |
| conventions | 4 |
| Address | |
| Program Addresses | 82 |
| Address Control | 133 |
| Address Counter | 87 |
| AJMP | 82 |
| Allocation Type | 109 |
| Allocation types | |
| BIT | 109 |
| BLOCK | 109 |
| BYTE | 109 |
| DWORD | 109 |
| PAGE | 109 |
| SEG | 109 |
| WORD | 109 |
| ampersand character | 149 |
| AND, operator | 88 |
| angle brackets | 149 |
| ANSI | |

Standard C Constant..... 160
 ANSI, defined 427
 AR0, register 75
 AR1, register 75
 AR2, register 75
 AR3, register 75
 AR4, register 75
 AR5, register 75
 AR6, register 75
 AR7, register 75
 argument, defined 427
 Arithmetic operators 88
 arithmetic types, defined 427
 array, defined 427
 ASCII, defined 427
 Assembler Controls 197
 Assembler Directives 99
 Introduction 99
 Assembler Macros 137
 Assembly Programs 69
 ASSIGN 322
 AT, relocation type 108
 AUTOEXEC.BAT 195
 AX51, defined 427

B

Bank Switching 264,293
 Bank Switching Configuration 297
 BANKAREA 332
 Banked Applications and HEX
 Files 389
 Banked object files 257
 Banking With Common Area 303
 Banking With Four 64 KByte
 Banks 299
 Banking With On-Chip Code
 ROM 301
 Banking With XDATA Port 302
 BANKx 333
 batch file, defined 427
 BI 334
 Binary numbers 84
 Binary operators 88
 Binary-Coded Decimal (BCD),
 defined 427

BIT 77,334
 BIT, allocation type 109
 BIT, operator 90
 BIT, segment type 107
 BITADDRESSABLE, relocation
 type 108
 BL51 Controls 271
 BL51 Linker/Locater 255
 BL51, defined 427
 BLOCK, allocation type 109
 block, defined 428
 bold capital text, use of 4
 braces, use of 4
 Bracket Function 172
 BSEG, directive 111
 BYTE, allocation type 109
 BYTE, operator 90
 BYTE0, operator 91
 BYTE1, operator 91
 BYTE2, operator 91
 BYTE3, operator 91

C

C Macros 156
 Examples 161
 C Preprocessor Side Effects
 162,424,426
 C, register 75
 C251, defined 428
 C251INC 195
 C251LIB 352
 C51, defined 428
 C51INC 195
 C51LIB 352
 CA, control 200
 CALL 82
 carat character 241
 CASE, control 200
 Character constants 86
 Choices, notational conventions 4
 Class 107
 Class operators 90
 CLASSES 336
 Classic 8051 28
 CO 338

| | | | |
|-----------------------------------|--------|-------------------------------|--------|
| CODE | 80,338 | NOLINES..... | 215 |
| Code Bank Areas | 294 | NOLIST | 211 |
| CODE, directive | 114 | NOMACRO | 216 |
| CODE, external symbol segment | | NOMOD51..... | 217 |
| type | 131 | NOOBJECT | 219 |
| CODE, operator | 90 | NOPRINT | 221 |
| CODE, segment type | 107 | NOREGISTERBANK..... | 222 |
| Colon Notation | 85 | NOREGUSE | 223 |
| Combining Program Modules..... | 258 | NOSYMBOLS | 218 |
| Combining Segments..... | 259 | NOSYMLIST..... | 225 |
| Command line..... | 196 | OBJECT | 219 |
| Comment Function | 170 | PAGELength | 220 |
| Comments..... | 71 | PAGEWIDTH..... | 220 |
| Common Code Area | 293 | PRINT | 221 |
| COND, control | 201 | REGISTERBANK | 222 |
| CONST | 80 | REGUSE | 223 |
| CONST, operator | 90 | RESET | 232 |
| CONST, segment type..... | 107 | RESTORE | 224 |
| constant expression, defined..... | 428 | SAVE | 224 |
| Constants in Bank Areas..... | 296 | SET | 231 |
| Control Summary..... | 305 | SYMLIST..... | 225 |
| control, defined..... | 428 | TITLE | 226 |
| Controls | | XREF | 227 |
| BL51 | 271 | courier typeface, use of..... | 4 |
| CASE | 200 | CPU | |
| COND | 201 | Instructions..... | 40 |
| DATE | 202 | CPU Registers..... | 36 |
| DEBUG | 203 | 8051 Variants..... | 36 |
| EJECT..... | 204 | Intel/Atmel WM 251 | 37 |
| ELSE..... | 235 | Create command | |
| ELSEIF..... | 234 | library manager | 379 |
| ENDIF | 236 | CSEG, directive | 111 |
| ERRORPRINT | 205 | CUBSTR Function..... | 185 |
| GEN..... | 207 | CX51, defined..... | 428 |
| IF..... | 233 | | |
| INCLUDE..... | 209 | D | |
| L251..... | 272 | DA..... | 339 |
| LIST..... | 211 | DA, control | 202 |
| LX51 | 272 | DATA | 77,339 |
| MOD_CONT | 212 | Data Overlaying..... | 280 |
| MOD_MX51 | 212 | DATA, directive | 114 |
| MOD51..... | 212 | DATA, external symbol segment | |
| MODSRC | 213 | type..... | 131 |
| MPL..... | 214 | DATA, operator..... | 90 |
| NOCOND | 201 | DATA, segment type | 107 |
| NOGEN | 207 | | |

-
- DATE, control 202
 - DB, control 203
 - DB, directive 119
 - DBIT, directive 122
 - DD, directive 121
 - DEBUG, control 203
 - Decimal numbers 84
 - declaration, defined 428
 - define 157
 - Defining a macro 140
 - definition, defined 428
 - Delete command
 - library manager 379
 - Differences between A251 and
 - ASM51 425
 - 32-bit evaluation 425
 - 8051 Symbols 425
 - Macro Processing Language 425
 - Object File 425
 - Reserved Symbols 425
 - Differences between A51 and
 - A251
 - 32-bit evaluation 423
 - 8051 Special Function
 - Registers 423
 - Object File 424
 - Reserved Symbols 423
 - Differences Between A51 and
 - A251 423
 - Differences between A51 and
 - ASM51 424
 - Interrupt Vectors 424
 - Macro Processing Language 424
 - Object File 424
 - Reserved Symbols 424
 - directive, defined 428
 - Directives
 - `_ERROR_` 136
 - BSEG 111
 - CODE 114
 - CSEG 111
 - DATA 114
 - DB 119
 - DBIT 122
 - DD 121
 - DS 123
 - DSB 124
 - DSD 126
 - DSEG 111
 - DSW 125
 - DW 120
 - END 136
 - ENDP 127
 - EQU 113
 - esfr 116
 - EVEN 134
 - EXTERN 131
 - EXTRN 131
 - IDATA 114
 - ISEG 111
 - LABEL 129
 - LIT 117
 - NAME 132
 - ORG 133
 - PROC 127
 - PUBLIC 130
 - RSEG 110
 - sbit 116
 - SEGMENT 106
 - sfr 116
 - sfr16 116
 - USING 134
 - XDATA 114
 - XSEG 111
 - Disable Data Overlaying 283
 - DISABLEWARNING 307
 - Displayed text, notational
 - conventions 4
 - Document conventions 4
 - dollar sign
 - location counter 87
 - used in a number 85
 - double brackets, use of 4
 - double semicolon 149
 - DPTR, register 75
 - DS, directive 123
 - DSB, directive 124
 - DSD, directive 126
 - DSEG, directive 111
 - DSW, directive 125
 - DW 307
 - DW, directive 120

DWORD, operator..... 90

E

EBIT 78
 EBIT, operator..... 90
 EBIT, segment type 107
 ECALL 82
 ECODE, operator 90
 ECODE, segment type..... 107
 ECONST, operator..... 90
 ECONST, segment type..... 107
 EDATA 79
 EDATA, operator 90
 EDATA, segment type..... 107
 EJ, control..... 204
 EJECT, control 204
 EJMP 82
 elif..... 157
 ellipses, use of 4
 ellipses, vertical, use of..... 4
 else..... 157
 ELSE, control 235
 ELSEIF, control..... 234
 END, directive..... 136
 endif..... 157
 ENDIF, control..... 236
 ENDP, directive..... 127
 EOF record 395
 EP, control..... 205
 EPTR, register 75
 EQ, operator 89
 EQU, directive..... 113
 error 157
 Error Messages 237
 Fatal Errors 237
 Non-Fatal Errors 241
 ERRORLEVEL 197,269
 ERRORPRINT, control..... 205
 Escape Function..... 171
 escape sequence, defined 428
 esfr, directive 116
 EVAL Function 178
 EVEN, directive 134
 Exceptions 375
 exclamation mark 149

Exit command
 library manager 379
 EXIT Function 183
 Expression
 Classes..... 93
 expression, defined 428
 Expressions 84,93
 Extended 8051 30
 Extended jumps and calls..... 82
 EXTERN, directive..... 131
 External symbol segment types 131
 Extract command
 library manager 379
 EXTRN, directive 131

F

FAR, operator 90
 FD, control..... 206
 Filename, notational conventions..... 4
 Files generated by Ax51 197
 FIXDRK 206
 formal parameters, defined..... 428
 function body, defined 429
 function call, defined..... 429
 function declaration, defined..... 429
 function definition, defined 429
 function prototype, defined 429
 Function Segments 281
 function, defined 428

G

GEN, control..... 207
 Generating a Listing File..... 263
 Generating an Absolute Object
 File 262
 Generic jumps and calls 82
 GT, operator..... 89
 GTE, operator 89

H

HCONST, operator 90
 HCONST, segment type..... 107
 HDATA 81
 HDATA, operator 90

HDATA, segment type 107
 Help command
 library manager 379
 HEX Files for Banked
 Applications 389
 Hexadecimal numbers 84
 HIGH, operator 91
 High-Level Language Controls 351

I

I2 210
 IB 323
 IBANKING 323
 IC, control 209
 ICE, defined 429
 ID 208,340
 IDATA 78,340
 IDATA, directive 114
 IDATA, external symbol
 segment type 131
 IDATA, operator 90
 IDATA, segment type 107
 if157
 IF Function 180
 IF, control 233
 ifdef 157
 ifndef 157
 In-block jumps and calls 82
 INBLOCK, relocation type 108
 INCDIR 208
 in-circuit emulator, defined 429
 include 157
 include file, defined 429
 Include Files 208
 INCLUDE, control 209
 INPAGE, allocation type 109
 INPAGE, relocation type 108
 INSEG, relocation type 108
 Instruction Sets 40
 Intel HEX
 Data record 395
 End-of-file record 395
 EOF record 395
 Example file 397

 Extended 8086 segment
 record 396
 Extended linear address
 record 396
 Record format 394
 Intel HEX file format 394
 Intel HEX files 257
 Intel/Atmel WM 251 34
 Interrupt 210
 INTR2 210
 Invoking a Macro 155
 Invoking Ax51 196
 ISEG, directive 111
 italicized text, use of 4
 IX 308
 IXREF 308

J

JMP 82

K

Key names, notational
 conventions 4
 keyword, defined 429

L

L251 Controls 272
 L251 Linker/Locater 255
 L251, defined 429
 L51, defined 429
 L51_BANK.A51 297
 LABEL, directive 129
 Labels 73
 Labels in macros 142
 LEN Function 184
 LI, control 211
 LIB251 377
 LIB251, defined 429
 LIB51 377
 LIB51, defined 429
 library manager
 Add command 379
 Create command 379
 Delete command 379

| | | | |
|----------------------------------|-----|-------------------------------------|---------|
| Exit command | 379 | LSB, defined | 430 |
| Extract command | 379 | LST files | 197 |
| Help command | 379 | LT, operator | 89 |
| List command | 379 | LTE, operator..... | 89 |
| Replace command..... | 379 | LX51 Controls | 272 |
| Transfer command | 379 | Lx51 Error Messages | 360 |
| Library Manager..... | 377 | Lx51 Linker | |
| library, defined | 429 | Control Summary | 305 |
| LIBx51 | | LX51 Linker/Locator | 255 |
| Add Object Modules..... | 381 | LX51, defined | 429 |
| Command line..... | 378 | | |
| Commands | 379 | | |
| Create a Library | 380 | M | |
| Error Messages | 384 | M51,control | 212 |
| Extract Object Modules | 382 | Macro definition | 140 |
| Interactive mode | 378 | Macro definitions nested..... | 147 |
| List Library Contents | 383 | Macro directives | 139 |
| Remove Object Modules | 382 | Macro invocation | 155 |
| Replace Object Modules..... | 381 | Macro labels..... | 142 |
| LIBX51..... | 377 | Macro operators | 149 |
| LIBX51, defined..... | 429 | ! 149,154 | |
| line..... | 157 | % | 149,153 |
| Linker Command Line Examples ... | 268 | & | 149,151 |
| Linker Controls..... | 270 | ;; 149,154 | |
| Linker/Locator | 255 | < 149,152 | |
| L251 | 255 | > 149,152 | |
| LX51 | 255 | NUL | 149,150 |
| Linking Programs | 266 | Macro parameters | 141 |
| List command | | Macro Processing Language | 163 |
| library manager..... | 379 | Macro Errors | 193 |
| LIST, control | 211 | MPL Functions..... | 170 |
| Listing File..... | 263 | MPL Macro | 164 |
| Listing File Controls..... | 306 | Overview | 163 |
| Listing File Format | 415 | Macro repeating blocks..... | 144 |
| File Heading..... | 417 | macro, defined | 430 |
| File Trailer | 421 | Macros and recursion..... | 148 |
| Include File Level | 419 | manifest constant, defined..... | 430 |
| Macro Level..... | 419 | MATCH Function | 186 |
| Save Stack Level..... | 419 | MBYTE, operator | 91 |
| Source Listing..... | 418 | MC,control..... | 212 |
| Symbol Table..... | 419 | MCS [®] 251, defined | 430 |
| LIT, directive..... | 117 | MCS [®] 51, defined | 430 |
| Locating Programs..... | 273 | memory classes | |
| Locating Segments..... | 260 | classic 8051 | 28,34 |
| Location Counter | 87 | extended 8051 | 30 |
| LOW, operator | 91 | Philips 80C51MX | 32 |

- | | | | |
|-------------------------------|-----|---------------------------------|-------------|
| Memory Classes..... | 27 | MS,control..... | 213 |
| BIT..... | 77 | MSB, defined..... | 430 |
| CODE..... | 80 | MX,control..... | 212 |
| CONST..... | 80 | MX51BANK.A51..... | 297 |
| DATA..... | 77 | | |
| EBIT..... | 78 | N | |
| EDATA..... | 79 | NA..... | 324 |
| HDATA..... | 81 | NAME..... | 324 |
| IDATA..... | 78 | NAME, directive..... | 132 |
| XDATA..... | 80 | Names..... | 72 |
| Memory Initialization..... | 119 | NE, operator..... | 89 |
| Memory Layout..... | 27 | NEAR, operator..... | 90 |
| Classic 8051..... | 29 | Nesting macro definitions..... | 147 |
| Extended 8051..... | 31 | newline character, defined..... | 430 |
| Intel/Atmel WM 251..... | 35 | NLIB..... | 352 |
| Philips 80C51MX..... | 33 | NOAJ..... | 325 |
| Memory Location Controls..... | 331 | NOAJMP..... | 325 |
| memory model, defined..... | 430 | NOCM..... | 309 |
| Memory Reservation..... | 122 | NOCOMMENTS..... | 309,316,330 |
| METACHAR Function..... | 173 | NOCOND, control..... | 201 |
| Miscellaneous operators..... | 91 | NODEBUGLINES..... | 326 |
| mnemonic, defined..... | 430 | NODEBUGPUBLICS..... | 326 |
| MOD, operator..... | 88 | NODEBUGSYMBOLS..... | 326 |
| MOD_CONT, control..... | 212 | NODEFAULTLIBRARY..... | 352 |
| MOD_MX51, control..... | 212 | NODL..... | 326 |
| MOD51, control..... | 212 | NODP..... | 326 |
| MODSRC, control..... | 213 | NODS..... | 326 |
| monitor51, defined..... | 430 | NOGEN, control..... | 207 |
| MPL Functions | | NOIC..... | 327 |
| Bracket..... | 172 | NOINDIRECTCALL..... | 327 |
| Comment..... | 170 | NOJT..... | 328 |
| Escape..... | 171 | NOLI..... | 310 |
| EVAL..... | 178 | NOLINES..... | 310,316,330 |
| EXIT..... | 183 | NOLINES, control..... | 215 |
| IF..... | 180 | NOLIST, control..... | 211 |
| LEN..... | 184 | NOLN,control..... | 215 |
| MATCH..... | 186 | NOMA..... | 311 |
| METACHAR..... | 173 | NOMACRO, control..... | 216 |
| REPEAT..... | 181 | NOMAP..... | 311 |
| SET..... | 177 | NOMO, control..... | 217 |
| SUBSTR..... | 185 | NOMOD51, control..... | 217 |
| WHILE..... | 181 | Non-Fatal Errors..... | 365 |
| MPL, control..... | 214 | NOOBJECT, control..... | 219 |
| MPL, Macro Processing | | NOOJ, control..... | 219 |
| Language | | NOOL..... | 353 |
| delimiters..... | 188 | | |

| | | | |
|-------------------------------|-------------|----------------------------|-----|
| NOOVERLAY | 353 | Command line | 388 |
| NOPR, control | 221 | Error messages | 390 |
| NOPRINT | 315 | OHX51 | 387 |
| NOPRINT, control | 221 | OHx51 Command Line | |
| NOPU | 312 | Examples | 389 |
| NOPUBLICS | 312,316,330 | OHx51 Error Messages | 390 |
| NORB, control | 222 | OHX51, defined | 431 |
| NOREGISTERBANK, control | 222 | OJ, control | 219 |
| NOREGUSE, control | 223 | OL | 354 |
| NORU, control | 223 | Omitted text, notational | |
| NOSB, control | 218 | conventions | 4 |
| NOSL, control | 225 | Opcode Map | 64 |
| NOSO | 341 | 251 Instructions | 66 |
| NOSORTSIZE | 341 | 8051 Instructions | 65 |
| NOSY | 313 | opcode, defined | 431 |
| NOSYMBOLS | 313,316,330 | operand, defined | 431 |
| NOSYMBOLS, control | 218 | Operands | 74 |
| NOSYMLIST, control | 225 | Operators | 84 |
| NOT, operator | 88 | Operator | 88 |
| NOTYPE | 329 | arithmetic | 88 |
| NUL, macro operator | 149,150 | binary | 88 |
| null character, defined | 430 | class | 90 |
| NULL macro parameters | 150 | miscellaneous | 91 |
| null pointer, defined | 430 | precedence | 92 |
| NUMBER, external symbol | | relational | 89 |
| segment type | 131 | type | 90 |
| Numbers | 84 | operator, defined | 431 |
| Colon Notation | 85 | Operators | |
| O | | (..... | 88 |
| OBJ files | 197 |) | 88 |
| object file, defined | 431 | * | 88 |
| OBJECT, control | 219 | / | 88 |
| object, defined | 431 | + | 88 |
| OBJECTCONTROLS | 330 | < | 89 |
| OC | 330 | <= | 89 |
| OC51 | 257,387 | <> | 89 |
| Command line | 392 | = | 89 |
| Octal numbers | 84 | > | 89 |
| OFFS, relocation type | 108 | >= | 89 |
| OH251 | 387 | AND | 88 |
| OH251, defined | 431 | BIT | 90 |
| OH51 | 387 | BYTE | 90 |
| OH51, defined | 431 | BYTE0 | 91 |
| OHx51 | 257 | BYTE1 | 91 |
| | | BYTE2 | 91 |
| | | BYTE3 | 91 |

- | | |
|-----------------------------------|---------|
| CODE..... | 90 |
| CONST | 90 |
| DATA | 90 |
| DWORD | 90 |
| EBIT | 90 |
| ECODE | 90 |
| ECONST..... | 90 |
| EDATA..... | 90 |
| EQ..... | 89 |
| FAR..... | 90 |
| GT..... | 89 |
| GTE..... | 89 |
| HCONST | 90 |
| HDATA..... | 90 |
| HIGH..... | 91 |
| IDATA..... | 90 |
| LOW | 91 |
| LT..... | 89 |
| LTE..... | 89 |
| MBYTE | 91 |
| MOD..... | 88 |
| NE..... | 89 |
| NEAR..... | 90 |
| NOT..... | 88 |
| OR..... | 88 |
| SHL..... | 88 |
| SHR..... | 88 |
| WORD | 90 |
| WORD0 | 91 |
| WORD2 | 91 |
| XDATA..... | 90 |
| XOR..... | 88 |
| Operators used in macros..... | 149 |
| Optimum Program Structure | |
| with Bank Switching..... | 294 |
| Optional items, notational | |
| conventions..... | 4 |
| OR, operator | 88 |
| ORG, directive..... | 133 |
| Output File..... | 269 |
| Output File Controls..... | 321 |
| Output files..... | 197 |
| OVERLAY..... | 354 |
| Disable..... | 283 |
| Usage..... | 282 |
| OVERLAYABLE, relocation | |
| type..... | 108 |
| Overlaying Data Memory..... | 261 |
| P | |
| PAGE, allocation type..... | 109 |
| PAGELNGTH..... | 314 |
| PAGELNGTH, control..... | 220 |
| PAGEWIDTH..... | 314 |
| PAGEWIDTH, control..... | 220 |
| parameter, defined..... | 431 |
| Parameters in macros | 141 |
| PATH | 195 |
| PC..... | 316,343 |
| PC, register..... | 75 |
| PDATA | 342 |
| Philips 80C51MX | 32 |
| Philips 80C51MX | |
| Assembler Example..... | 410 |
| C Compiler Example | 411 |
| Extended SFR space..... | 116 |
| Physical Memory..... | 273 |
| PL, control..... | 220 |
| PL/M-51 | |
| Defined..... | 431 |
| Pointer to Function | |
| Arrays or Tables | 286 |
| as Function Argument..... | 284 |
| pointers, defined..... | 431 |
| PR, control | 221 |
| PR0, register..... | 75 |
| PR1, register..... | 75 |
| pragma..... | 157 |
| pragma, defined..... | 431 |
| PRECEDE..... | 343 |
| Precedence of operators | 92 |
| Predefined C Macro Constants..... | 160 |
| __A51__..... | 160 |
| __DATE__..... | 160 |
| __FILE__..... | 160 |
| __KEIL__..... | 160 |
| __LINE__..... | 160 |
| __STDC__..... | 160 |
| __TIME__..... | 160 |
| Predefined Constants..... | 230 |

| | | | |
|-----------------------------|-------------|-------------------------------------|---------|
| __INTR4__ | 230 | R6, register | 75 |
| Predefined Macro Constants | | R7, register | 75 |
| __MODBIN__ | 230 | RAMSIZE | 344 |
| __MODSRC__ | 230 | RB, control | 222 |
| Preprocessor directives | | RE | 345 |
| define | 157 | RECURSIONS | 356 |
| elif | 157 | Recursive macros | 148 |
| else | 157 | REGFILE | 357 |
| endif | 157 | Register names | 75 |
| error | 157 | REGISTERBANK, control | 222 |
| if157 | | REGUSE, control | 223 |
| ifdef | 157 | Relational operators | 89 |
| ifndef | 157 | Relative jumps | 82 |
| include | 157 | relocatable, defined | 431 |
| line | 157 | Relocation Type | 108 |
| pragma | 157 | Relocation types | |
| undef | 157 | AT | 108 |
| preprocessor, defined | 431 | BITADDRESSABLE | 108 |
| PRINT | 315 | INBLOCK | 108 |
| PRINT, control | 221 | INPAGE | 108 |
| PRINTCONTROLS | 316 | INSEG | 108 |
| Printed text, notational | | OFFS | 108 |
| conventions | 4 | OVERLAYABLE | 108 |
| PROC, directive | 127 | REPEAT Function | 181 |
| Procedure Declaration | 127 | Repeating blocks | 144 |
| Program Code in Bank and | | Replace command | |
| Common Code Areas | 295 | library manager | 379 |
| Program Linkage | 130 | RESERVE | 345 |
| Program Status Word | 39 | RESET, control | 232 |
| Program Template | 23 | Resolving External References | 261 |
| PSW | 39 | RESTORE, control | 224 |
| PU | 317 | RS | 344 |
| Public Symbols in | | RS, control | 224 |
| L51_BANK.A51 | 298 | RSEG, directive | 110 |
| PUBLIC, directive | 130 | RTX251 | 265,358 |
| PURGE | 316,317,330 | RTX251 Full, defined | 432 |
| PW, control | 220 | RTX51 | 265,358 |
| | | RTX51 Full, defined | 432 |
| R | | RTX51 Tiny | 265 |
| R0, register | 75 | RTX51 Tiny, defined | 432 |
| R1, register | 75 | RTX51TINY | 358 |
| R2, register | 75 | RU, control | 223 |
| R3, register | 75 | Running Ax51 | 196 |
| R4, register | 75 | run-time libraries | 352 |
| R5, register | 75 | | |

S

| | |
|-----------------------------------|-----|
| SA, control..... | 224 |
| sans serif typeface, use of | 4 |
| SAVE, control..... | 224 |
| SB, control..... | 218 |
| sbit, directive | 116 |
| scalar types, defined..... | 432 |
| scope, defined | 432 |
| SE | 346 |
| SEG, allocation type | 109 |
| Segment Controls | |
| Location Counter..... | 102 |
| Segment Directives | 102 |
| Segment Location Controls..... | 331 |
| Segment Naming Conventions..... | 258 |
| Segment types | |
| BIT | 107 |
| CODE..... | 107 |
| CONST | 107 |
| DATA | 107 |
| EBIT | 107 |
| ECODE..... | 107 |
| ECONST..... | 107 |
| EDATA..... | 107 |
| HCONST | 107 |
| HDATA..... | 107 |
| IDATA..... | 107 |
| XDATA..... | 107 |
| SEGMENT, directive | 106 |
| Segments | |
| absolute | 105 |
| default | 105 |
| generic..... | 103 |
| stack | 104 |
| SEGMENTS | 346 |
| Segments in Bank Areas | 296 |
| Segments of Functions | 281 |
| SEGSIZE | 348 |
| semicolon character | 71 |
| SET Function..... | 177 |
| SET, control..... | 231 |
| sfr, directive | 116 |
| sfr16, directive | 116 |
| SHL, operator | 88 |
| SHR, operator | 88 |
| SJMP | 82 |
| SL, control..... | 225 |
| source file, defined | 432 |
| Special Function Register (SFR), | |
| defined..... | 432 |
| SPEEDOVL | 359 |
| SS | 348 |
| ST..... | 349 |
| STACK..... | 349 |
| stack, defined..... | 432 |
| Statements | 69 |
| Controls | 70 |
| Directives..... | 70 |
| Instructions | 70 |
| static, defined | 432 |
| stream functions, defined..... | 432 |
| string literal, defined | 432 |
| string, defined..... | 432 |
| Stringize Operator | 157 |
| Strings | 87 |
| structure member, defined..... | 433 |
| structure, defined..... | 433 |
| Symbol Definition | 113 |
| Symbol Names | 72 |
| Symbols..... | 72 |
| SYMLIST, control | 225 |
| T | |
| TEMPLATE.A51 | 23 |
| TITLE, control | 226 |
| TMP | 195 |
| token, defined..... | 433 |
| Token-Pasting Operator | 159 |
| Transfer command | |
| library manager..... | 379 |
| TT, control | 226 |
| two's complement, defined..... | 433 |
| type cast, defined..... | 433 |
| Type operators..... | 90 |
| type, defined..... | 433 |
| U | |
| Unary -, operator | 88 |
| Unary +, operator | 88 |

| | |
|-----------------------|-----|
| undef..... | 157 |
| Using OC51 | 392 |
| Using OHx51 | 388 |
| USING, directive..... | 134 |

V

| | |
|---------------------------|-----|
| Variables, notational | |
| conventions..... | 4 |
| Version Differences..... | 162 |
| vertical bar, use of..... | 4 |

W

| | |
|------------------------------------|-----|
| Warning detection | 318 |
| WARNINGLEVEL | 318 |
| Warnings | 360 |
| WHILE Function..... | 181 |
| whitespace character, defined..... | 433 |
| wild card, defined | 433 |

| | |
|----------------------------|-----|
| WL | 318 |
| WORD, allocation type..... | 109 |
| WORD, operator..... | 90 |
| WORD0, operator..... | 91 |
| WORD2, operator..... | 91 |

X

| | |
|--------------------------|--------|
| XD | 350 |
| XDATA | 80,350 |
| XDATA, directive..... | 114 |
| XDATA, external symbol | |
| segment type..... | 131 |
| XDATA, operator | 90 |
| XDATA, segment type..... | 107 |
| XOR, operator..... | 88 |
| XR, control | 227 |
| XREF, control | 227 |
| XSEG, directive | 111 |